

A

Subject: Briefing, Compatibility Test of UH-60A, CH-47R and HH-53H Helicopters [redacted]

To: Major General Vaught

Introduction:

Early in our planning process we identified a potential requirement to launch helicopters from [redacted]. We investigated the potential of [redacted]. The [redacted] was identified as the only [redacted] that would meet our requirements which were: (1) capable of [redacted] sufficient numbers of the four type helicopters we are working with and (2) capable of rapidly moving the helicopters to the [redacted] for flight operations.

A, B

Description of [redacted]

There are [redacted] in existence, all owned by [redacted] (Refer to Fact Sheet). The [redacted] are designed to [redacted] on each of [redacted]. The model shows the barges on the [redacted] and rear of the [redacted]. The [redacted] are [redacted] onto the [redacted] and lifted to one of [redacted] the [redacted], the [redacted] or the [redacted] deck. A hydraulic transporter then rolls under the [redacted], lifts them and rolls them to position on the [redacted] and lowers them onto [redacted] which run the length of the [redacted] on all [redacted]. The [redacted] are essentially side by side, [redacted] high. (See picture in packet) These four [redacted] could be used to store the helicopters. Disassembly requirements to make the helicopters fit into the [redacted] are minimal. For UH-60A, and CH-47R only main rotors need be folded. For the HH-53, at least four of the six main rotors would have to be removed, since there is no main rotor fold capability. Without removing the [redacted] the helicopters could be [redacted] according to the attached diagrams. Total [redacted] capacity for each type helicopter and a mixed load are shown on the Fact Sheet.

A, B

The [redacted] would be the [redacted]. Template analysis indicates that it can accommodate the number of helicopters indicated on the Fact Sheet.

A, B

533

pg. 625

Classified By: ~~JES~~ DDO, NMCC
Declassified ON: OADR
DDO, NMCC
4 Aug 92

A, B

(C) In order to determine if the ship could meet our requirements, or future requirements of the CTJTF or RDJTF, we need to run a test to confirm our analysis and answer some key questions. Can the Seabee support helicopter landings and take off - particularly while it is underway at slow speeds? Can we maneuver the helicopters around the deck without removing the barge pedestals? What deck spots can we land and take off from, what can we do to increase the number of spots? What modifications to the ship might be required? The attached compatibility test lists several other objectives.

A, B

(C) We have contacted [redacted] to discuss [redacted] of a [redacted] for the conduct of the test. They have indicated that the [redacted] could be made available in [redacted] for three days beginning on or about 26 October. The cost estimate is \$186,000 plus as much as \$30,000 [redacted]. These costs would have to be [redacted] by the [redacted] which normally arranges such [redacted].

(C) We would use helicopters from the 101st Airborne and the First SOW so that some of our crews would gain experience.

(U) We recommend that the normal test agencies at Combat Developments and the Transportation Engineering Agency be involved to insure that the knowledge gained during the test could be disseminated to other interested staffs and units.

A

(C) After the test, we will be in a better position to evaluate the potential of the [redacted] for our operation.

G

[redacted]

Major, USA

Inclosures
a/s

~~(S)~~ COMPATIBILITY TEST OF UH-60A, CH-47 R AND HH-53H
HELICOPTERS

~~(S)~~ Test Dates: 26-28 October

Location: [REDACTED]

Cost: \$62,000 per day + \$10,000 per day insurance (est)
Total \$216,000

Helicopters: 8 UH-60A, 4 CH-47R and 4 HH-53H

Test Objectives: To determine, for each type helicopter:

~~(S)~~ 1. Landing procedures:

- a. maximum number of [REDACTED] landing spots usable
- b. time interval between aircraft landings
- c. ground handling requirements to expedite landings
- d. safety procedures

~~(S)~~ 2. The time, equipment, personnel and procedures required to move helicopters [REDACTED]

- a. tow tug requirements and aircraft maneuverability
- b. blade folding/removal equipment and spots
- c. number of aircraft that can be moved on and off the [REDACTED]

(U) 3. Aircraft tiedown procedures and equipment.

~~(S)~~ 4. The time, equipment, personnel and procedures required to cycle helicopters from [REDACTED] to the [REDACTED]

- a. towing procedures
- b. blade unfolding/hanging spots and special equipment

(U) 5. Take-off procedures:

- a. aircraft spotting for maximum density launch
- b. maximum number of take-off spots
- c. time interval between aircraft take-off
- d. safety procedures

~~SECRET~~
~~SECRET~~

A ~~SECRET~~ FACT SHEET

~~(S)~~ Length

Width

A

Owner:

Number:

~~(S)~~ Helicopter Capacities (in Place)

	UH-60A	CH-47	HH-53
██████████	40	48	16
██████████	<u>40</u>	<u>48</u>	<u>16</u>
Total ██████████	80	96	32
██████████ (Blades Unfolded)	14	6	8

~~(S)~~ Mixed Load (Sample)

~~██████████~~ (left) 8 HH-53
~~██████████~~ (right) 12 CH-47 & 10 UH-60A
~~██████████~~ (left) 20, UH-60A
~~██████████~~ (right) ~~██████████~~

~~SECRET~~
~~SECRET~~

SECRET

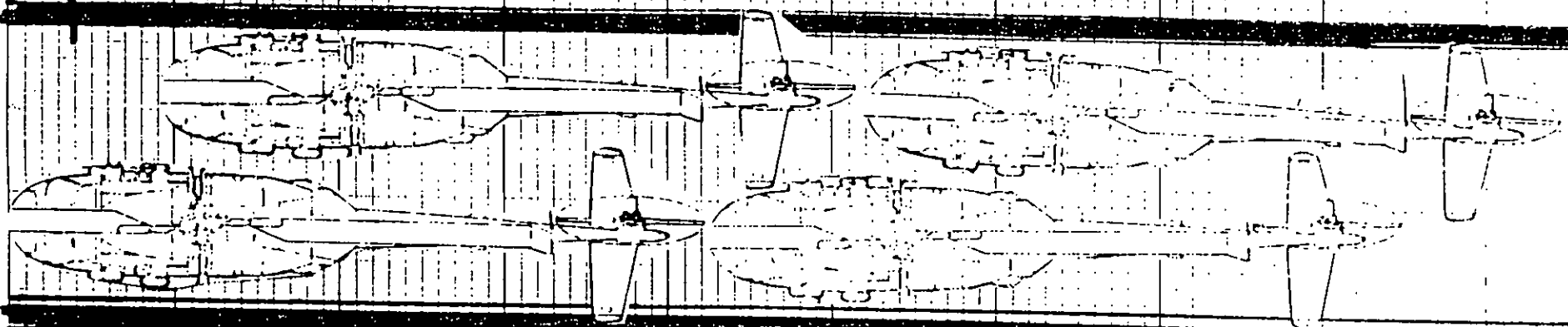

SECRET

~~SECRET~~

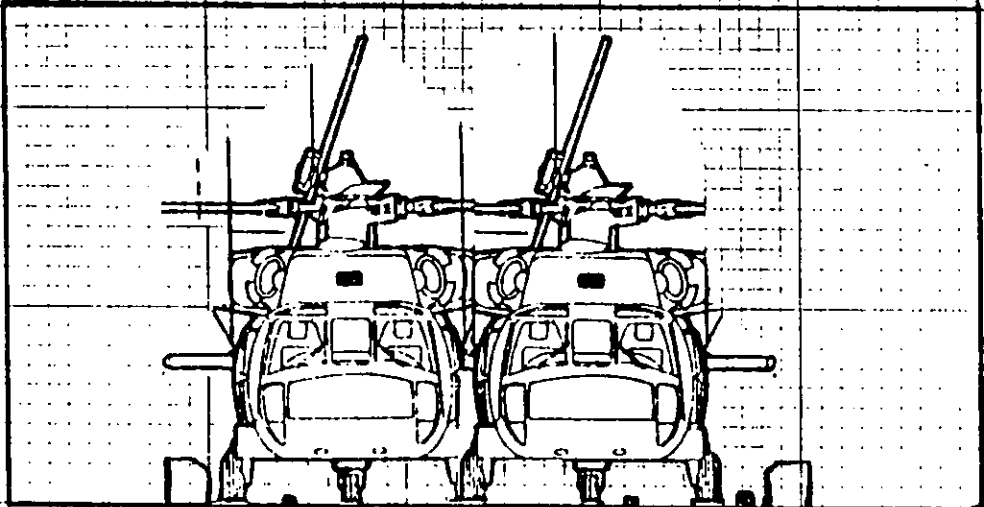

19'3"

37'7"

UH-60A

~~SECRET~~

~~SECRET~~

A

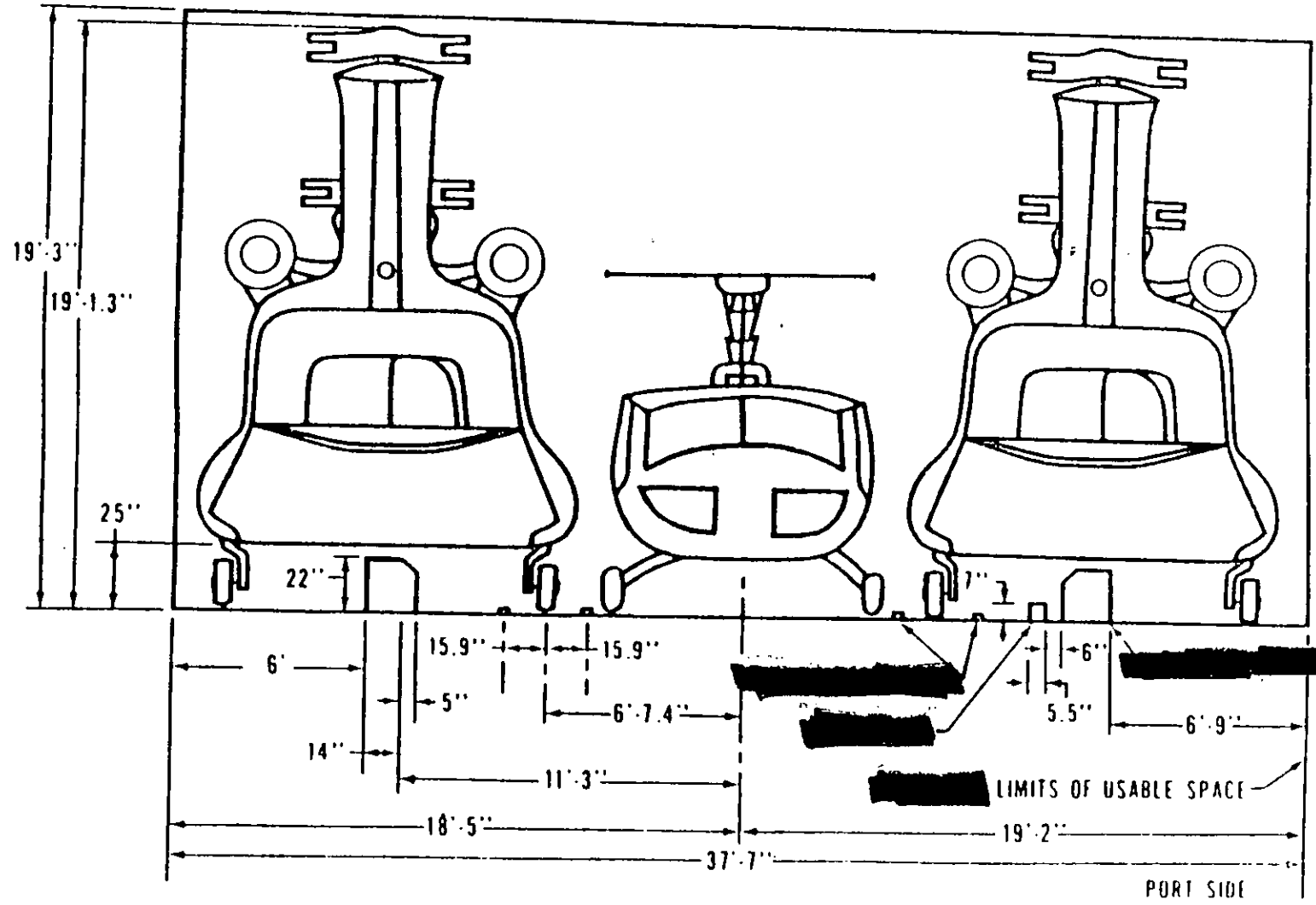
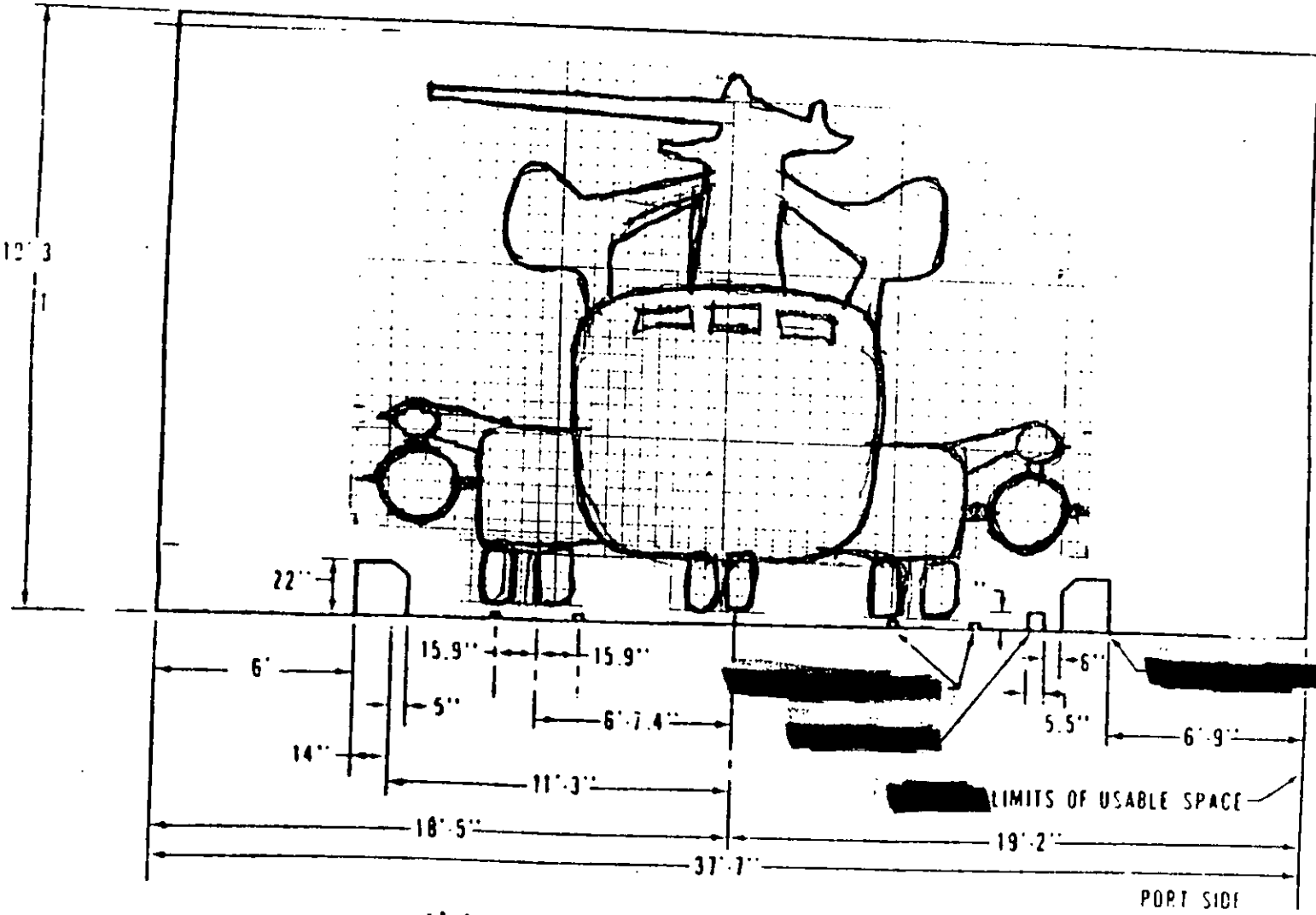

Figure 69. Detailed Helicopter Loading

~~SECRET~~

~~SECRET~~



HH-53
Figure 69. Detailed Helicopter Loading

A

~~SECRET~~

~~SECRET~~

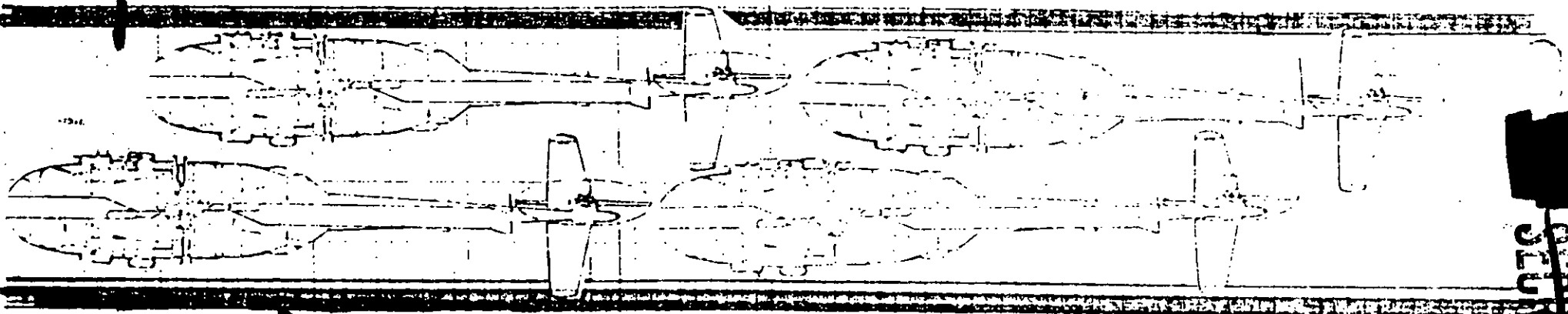

~~SECRET~~

A

Scale 1"=125ft

~~SECRET~~

J-4

- A ^{fst} [redacted] TEST

Status as of 22 August

OPSDEPS decision on 19 Aug was to proceed with test but delay it until new FY in October.

G Col [redacted] (DCSOPS) wanted JTD to generate new dates in Oct and better costs data.

^{fst} I have contacted [redacted] and given him the following requirements:

A

- (1) [redacted]
- (2) [redacted]
- (3) 3 days - 1 maybe 2 [redacted] 1 at [redacted]
- (4) Helo opns - [redacted]
- (5) [redacted] cheapest for [redacted] (adequate space, USAF airfield nearby).
- (6) After 1 Oct.

I will call him Tues 26 Aug to get dates and refined cost figures. Info will be transmitted to JTD by me.

[redacted]

Classified By: DDONMCC
Declassified ON: 4 Aug 92
OAPR

Downgraded to Secret by DDONMCC 4 Aug 92

~~SECRET~~

~~SECRET~~

A (S) BACKGROUND PAPER - [REDACTED] TEST

A
1. The [REDACTED] is the only [REDACTED] which has the capabilities to (1) conceal [REDACTED] HH60A, CH-47R and HH-53H helicopters and (2) conduct [REDACTED] operations with the helicopters.

2. There are several questions which must be answered to confirm engineering analysis. The proposed test will determine, for each type helicopter, the following:

- A, B
- a. How many helicopters can be maneuvered on and off the [REDACTED]
 - b. Can ground handling tugs maneuver around the [REDACTED] to return inside the [REDACTED] after spotting the helicopters on the [REDACTED]
 - c. How many launch and landing positions can be used simultaneously?
 - d. What [REDACTED] obstructions need to be removed to increase the number of launch positions?
 - e. What is the cycle time for one lift of aircraft from [REDACTED]
 - f. What special tools and equipment are required?
 - g. How many personnel are required for required helicopter disassembly/reassembly?

A, B
3. Since the [REDACTED] are in continuous [REDACTED] test dates must coincide with [REDACTED] availability in [REDACTED]. Requirements are: (1) the [REDACTED] feet of [REDACTED] be clear, and (3) [REDACTED] to rescue air crews.

(w) 4. Additional military equipment required includes:

- a. Fire fighting apparatus (foam truck).
- b. Ground handling tugs and tow bars (8 of each).
- c. 250 Lb. CO² Fire Extinguishers (wheel mounted) (2 ea)

A, B
5. Test cycle would include [REDACTED] of ground handling and safety equipment and at [REDACTED] of helicopters.

~~SECRET~~

T.S.

7/31/80

Memo to MG VAUGHT

Subj: SNOWBIRD VII

~~SECRET~~
~~SECRET~~

I agree that pursuit of [redacted]
[redacted] system is attractive - but only
for use by JTF in other areas.

[redacted] launch requires
that [redacted] be in stage of 20-24 hr
[redacted]

from [redacted] off, indeed,
SPSEC is maintained until launch time
has been will be no doubt of [redacted] role
as operations begin. Thus, [redacted] becomes
an indefensible target during ingress from
[redacted]

Current JCS plans call for withdrawal
CMCF assets [redacted] prior to success on
of plan execution (minus [redacted] which

A, B

~~SECRET~~
~~SECRET~~

~~name~~ [redacted] A,

Cannot believe extraction can be accomplished without injury to Iranians.

Therefore, on day after a successful mission they can be expected to be looking for "fore-seeing" options.

VR,
[Signature]

~~SECRET~~
~~SECRET~~
[Signature]

~~SECRET~~
~~SECRET~~
~~SECRET~~

②
-5

~~CONFIDENTIAL~~

J-6

⑥

OPTIONS

SNOWBIRD

(c) LAUNCH BASE

(s) ASSETS REQUIRED

- I [REDACTED]
- II [REDACTED]
- III [REDACTED]
- IV [REDACTED]
- (SHORT WARNING)
- V [REDACTED] OR TANKER
(NO HELICOPTERS)
- VI [REDACTED]
- VII PERSIAN GULF
- VIII GULF OF OMAN
- IX [REDACTED]
- X [REDACTED] GULF

- PAVE LOW M/A/HC-130 F-14 C141B (STRETCH)
- PAVE LOW M/A/HC-130 F-14
- PAVE LOW M/A/HC-130 F-14
- PAVE LOW M/A/HC-130 C-5
- MIL VEH C-5 AC-130 C-141B (STRETCH)
- PAVE LOW M/A/HC-130 CH-47 F-14
- PAVE LOW UH-60 [REDACTED]
M/A/HC-130 F-14
- LPH (OR [REDACTED]) PAVE LOW
- UH-60 M/A/HC-130
- [REDACTED] M/AC-130 C-141B (STRETCH)
- UH60/[REDACTED] PL C141B/M/A/EC-130 F-14

HE

~~TOP SECRET~~

Classified By DDONMCC
Declassified On FOUO 4 Aug 9
OADR

Downgraded to CONFIDENTIAL
by DDONMCC

~~CONFIDENTIAL~~

TRAINING EVENTS

FORT BLISS

DUGWAY

_ MASKS RQD -

6 JULY

HELOS

LOW LEVEL NAV

SHORT ROUTES

CO LEVEL ROTATION

LZ MARKING/BEACON NAV

CCT

NITE FIRING
NITE DRIVING
POW HANDLING
CONVOY MOVEMENT
DZ MARKING



AC/MC 130

TAC FORMATION

NAVIGATION

SUPPORT OF [REDACTED]

7 JULY

AS ABOVE

PLUS

POL TECHNIQUES

R-9 SIMULATION

IP DISCUSSION ON INTEGRATION

AS ABOVE

~~TOP SECRET~~

CONFIDENTIAL

~~(S)~~ FT BLISS
PER 6 & 7 JULY
PLUS
MC-130 SPT AT DUGWAY

8 JULY

DUGWAY
PER 7 JULY
PLUS
POL W/MC/AC
CAMY/CONCEAL

A [REDACTED] 1ST SOW
PLANNING FOR AFLD SEIZURE

9 JULY

HELOS
INTEGRATED OPS
LOW LEVEL NAV
SHORT RANGE
TRANSLOADING
CAMY/CONCEAL

A [REDACTED] 1ST SOW
AIRFIELD SEIZURE
FULL REHEARSAL
TWO AIRFIELDS SIMULTANEOUS

10 JULY

CONFIDENTIAL

~~TOP SECRET~~

~~TOP SECRET~~

~~CONFIDENTIAL~~

FORT BLISS

11 JULY

DUGWAY

[REDACTED] MC/AC 130

FULL DRESS REHEARSAL

AFLD SEIZURE

[REDACTED]

HELOS

INTEGRATED OPS

LONG RANGE

LZ MARKING

POL OPS

CAMY/CONCEAL

12 JULY

A [REDACTED]
REVIEW AS RQD

AC-130

AIRCRAFT DESTRUCTION MSN

MC 130

REVIEW AS RQD

PER 11 JULY

PLUS

4 P.L. & 8 B. H.

TO

FT BLISS

~~CONFIDENTIAL~~

~~TOP SECRET~~

~~CONFIDENTIAL~~

(S)

FT BLISS

13 JULY

DUGWAY

PAVE LOW/BLK HWK FAM

HELO(-)

A' AFLD EXTRACTION [REDACTED]

EMBASSY PICKUP (DELTA)

LNO

CONVOY PICKUP

TEAM

INTERNAL TNG

A [REDACTED]
AFLD EXTRACTION

CCT

LZ ORG

POL TECHNIQUES

HELOS/MC 130

POL TECHNIQUES

A AC 130
[REDACTED]

~~CONFIDENTIAL~~

~~TOP SECRET~~

~~CONFIDENTIAL~~

FT BLISS

(S)

14 JULY

DUGWAY

(S)

A [REDACTED] HELOS/1ST SOW

PLANNING FOR AFLD SEIZURE

HELOS

MAINT. STANDOWN

PLANNING

15 JULY

A [REDACTED] 1ST SOW

AIRFIELD SEIZURE

DUGWAY

RTN ORO GRANDE

HELOS

LONG ROUTE

TIMED W/AFLD SEIZURE

HELOS

RTB DUGWAY

LZ MARKING

POL OPS

HC/MC SPT

TIMED W/AFLD SEIZURE

~~CONFIDENTIAL~~

~~TOP SECRET~~

~~TOP SECRET~~

16 JULY

STAND DOWN

CDR'S CONF

17 JULY

TRAINEX - CONCEPT TBD

~~TOP SECRET~~

~~CONFIDENTIAL~~

J- (15)

TOP
2120/32

MEM 0427
DTG 211845Z AUG 82
FM [REDACTED]
TO [REDACTED]
BT

A

~~CONFIDENTIAL~~

SUBJ: AC/MC-102 LOCATION
AS OF 211845Z

- 1. AC 102/AIR REFUELABLE
 - 0507- HURLBURT. DEPARTS 24 AUG FOR LAS. ATE 6 SEPT
 - 0508- HURLBURT. DEPARTS 24 AUG FOR LAS. ATE 6 SEPT.
 - 0572- LAS ATE 24 AUG
 - 0575- HURLBURT. DEPARTS 21 AUG FOR FIVE DAY TLY TO HOLLAND
(LOW LEVEL TRO)
 - 0576- HURLBURT

- 2. MC-102
 - 0502-A/A- HURLBURT
 - 0507-A/A- HURLBURT
 - 0572-A/A- HURLBURT
 - 0504-A/A- LAS- ATE APPROX 29 AUG
 - 7705-A/A- HURLBURT*
 - 1840-A/A- HURLBURT
 - 0508- - HURLBURT
 - 0501- HURLBURT
 - 0509- [REDACTED]

BTW 21 AUG 82
T
0427

Classified by
DDO NMCC-4 Aug 92
Declassify on: OADR

~~CONFIDENTIAL~~

~~CONFIDENTIAL~~

J- (7)

OCT 87

A/S

~~SECRET~~

NC/AC/EC/STATUS

EC-130E

A/R-HRT

PACAF

NORTON (ETR 10 OCT 1750L)

A/R-HRT (PACAF)

PACAF

A/R-HRT

A/R-HRT

DAVIS-CONF

HRT

A/R-HRT

A/R-HRT

A/R-HRT

A/R-HRT

A/R-HRT

IN A/R MOD AT LAS ETR 13 JAN 71

8. (U) EC-130E

1818-A/R-KEESLER

1825-A/R-KEESLER

1857-A/R-KEESLER

REVW 07 OCT 87

BT

#0221

Classified by DDO NMCC
4 Aug 92
Declassify on OADR

Downgraded to CONFIDENTIAL
by DDO NMCC
4 Aug 92

~~CONFIDENTIAL~~

~~CONFIDENTIAL~~
INDIAN OCEAN/PERSIAN GULF DEPLOYMENTS

TASK FORCE 70

EISENHOWER TG 70.9
AIRCRAFT ASSIGNED

22 F-14	4 EA-6B
24 A-7E	10 S-3A
10 A-6E	6 SH-3H
4 KA-6D	3 RH-53
4 E-2C	

SCHEDULE

ON STATION ARABIAN SEA

CONSTELLATION TG 70.1
AIRCRAFT ASSIGNED

24 F-14	4 EA-6B
12 A-7E	3 RH-53
10 A-6E	6 SH-3H
4 KA-6D	10 S-3A
2 EA-3B	1 C-2A

SCHEDULE

ON STATION ARABIAN SEA

MILITARY OPTIONS—AIRCRAFT AND LOCATIONS

	GUAM	EUROPE	HURLBURT
CONFIDENTIAL	4 B-52H	4 MC-130 (NOT AAR)	9 AC-130 (5 NOT AAR)
2 P-3C (HARPOON)	6 KC-135		2 MC-130 (1 AT NORTON AFB, 1 NOT AAR)
2 P-3B			
1 EP-3			
4 KC-135			

LANDING FORCE SIXTH FLEET (1,936 USMC PERSONNEL)

SHIPS	AIRCRAFT	TROOPS EMBARKED
INCHON (LPH-12)	4 CH-53D	34TH MAU
AUSTIN (LPD-4)	12 CH-46D	
SPIEGEL GROVE (LSD-32)	4 AH-1T	
SPARTANBURG COUNTY (LST-1192)	2 UH-1N	
FAIRFAX COUNTY (LST-1193)		

SCHEDULE

19-25 MAY UPKEEP ITALIAN PORTS

26 MAY-3 JUN OPS IONIAN SEA

4-5 JUN ENROUTE SPANISH PORTS

6-12 JUN PORT VISITS

13 JUN ENROUTE ROTA, SPAIN

FLEET MARINE FORCE SEVENTH FLT (3,195 USMC PERSONNEL)

SHIPS	AIRCRAFT	TROOPS EMBARKED
ARG ALFA	4 CH-53D	31ST MAU
OKINAWA (LPH-3)	12 CH-46D	
MOBILE (LKA-115)	4 AH-1T	
ALAMO (LSD-33)	2 UH-1N	1,895 TROOPS
SAN BERNARDINO (LST-1189)		BLT OKINAWA
* GRIDLEY (CG-21)		1,300 TROOPS
BARBEY (FF-108B)		
ARG BRAVO		
CLEVELAND (LPD-7)		
ANCHORAGE (LSD-36)		
<u>ARG ALFA</u>	<u>ARG BRAVO</u>	
EN ROUTE TO AUSTRALIA	CLEVELAND (SUBIC)	
	ANCHORAGE (SUBIC)	
* DSE EQUIPPED		

Amended to CON by DDONM 4 Aug 92

INDIAN OCEAN/PERSIAN GULF DEPLOYMENTS

TASK FORCE 70

1 JULY 1980
2 July '80

EISENHOWER TG 70.9
AIRCRAFT ASSIGNED

23 F-14 4 EA-6B
24 A-7E 10 S-3A
10 A-6E 6 SH-3H
4 KA-6D 3 RH-53
4 E-2C

SCHEDULE

ON STATION ARABIAN SEA

CONSTELLATION TG 70.4
AIRCRAFT ASSIGNED

24 F-14 4 E-2C
12 A-7E 3 RF-8G
10 A-6E 6 SH-3H
4 KA-6D 10 S-3A
2 EA-3B 1 US-3
1 C-2

SCHEDULE

ON STATION ARABIAN SEA

MILITARY OPTIONS - AIRCRAFT AND LOCATIONS

~~██████████~~ GUAM EUROPE
2 P-3C (HARPOON) 4 B-52H 4 MC-130 (NOT AAR)
2 P-3B 6 KC-135

1 EP-3
5 KC-135

HURLBURT

9 AC-130 (4 NOT AAR)
8 MC-130 (2 NOT AAR)

WEST CONUS OT & E

~~1 MC-130~~

LANDING FORCE SIXTH FLEET (1,725 USMC PERSONNEL)

SHIPS	AIRCRAFT	TROOPS EMBARKED
GUADALCANAL (LPH-7)	4 CH-53D	32nd MAU
NASHVILLE (LPD-13)	12 CH-46E	1,725 TROOPS
PENSACOLA (LSD-38)	4 AH-1T	
LAMOURE CTY (LST-1194)	2 UH-1N	

BARNSTABLE CTY (LST-1197)

SCHEDULE

1-5 JUL VISIT SPANISH PORTS
6-11 JUL TUNISIA (TRANCH 7-80)
12-23 JUL ENROUTE KENYA (TENTATIVE)
24-31 JUL AMPHIB EXERCISE KENYA (TENTATIVE)

FLEET MARINE FORCE SEVENTH FLEET (2,848 USMC PERSONNEL)

SHIPS	AIRCRAFT	TROOPS EMBARKED
ARG ALFA	4 CH-53D	31st MAU (ARG ALFA)
NEW ORLEANS (LPH-11)	12 CH-46E	1,718 TROOPS
VANCOUVER (LPD-2)	4 AH-1T	
FREDERICK (LST-1184)	1 UH-1N	BLT (ARG BRAVO)
RACINE (LST-1191)		1,130 TROOPS

ARG BRAVO

DUBUQUE (LPD-8)
FRESNO (LST-1182)

ARG ALFA SCHEDULE

28 JUN-12 JUL UPKEEP SUBIC BAY
13-15 JUL ENROUTE OKINAWA
15-21 JUL PHIBLEX OKINAWA

INDIAN OCEAN, PERSIAN GULF DEPLOYMENTS

TASK FORCE 70

7 JULY 1980

EISENHOWER TG 70.0
AIRCRAFT ASSIGNED

23 F-14	4 EA-6D
24 A-7E	10 S-3A
10 A-6E	6 SH-3H
4 KA-6D	3 H11-53
4 E-2C	

SCHEDULE

ON STATION ARABIAN SEA

CONSTELLATION TG 70.4
AIRCRAFT ASSIGNED

24 F-14	4 E-2C
12 A-7E	3 RF-6G
10 A-6E	6 SH-3H
4 KA-6D	10 S-3A
2 EA-3B	1 US-3
	1 C-2

SCHEDULE

ON STATION ARABIAN SEA

MILITARY OPTIONS - AIRCRAFT AND LOCATIONS

GUAM:	EUROPE
2 P-2C (HARPOON)	4 B-52H
2 P-2B	6 KC-135
1 EP-3	
5 KC-135	

HURLBURT
 6 P AC-130 (NOT AAR)
 5 P MC-130 (2 NOT AAR)

WEST COAST OTCF
 3 AC-130 (NOT AAR)
 3 MC-130 (NOT AAR)
 ALL AIR 2:11

LANDING FORCE SIXTH FLEET (1,725 USMC PERSONNEL)

SHIPS	AIRCRAFT	TROOPS EMBARKED
GUADALCANAL (LPH-7)	4 CH-53D	32ND MAU
NASHVILLE (LPD-13)	12 CH-36E	1,725 TROOPS
PENSACOLA (LSD-30)	4 AH-1T	
LANCURE CTY (LST-1194)	2 UH-1H	

SCHEDULE

1-5 JUL VISIT SPANISH PORTS
 6-11 JUL TUNISIA (TRANCH 7-80)
 12-23 JUL ENROUTE KENYA (TENTATIVE)
 24-31 JUL AMPHIB EXERCISE KENYA (TENTATIVE)

FLEET MARINE FORCE SEVENTH FLEET (2,348 USMC PERSONNEL)

SHIPS	AIRCRAFT	TROOPS EMBARKED
ARG ALFA	4 CH-53D	31ST MAU (ARG ALFA)
NEW ORLEANS (LPH-11)	12 CH-36E	1,718 TROOPS
VANCOUVER (LPD-2)	4 AH-1T	
FREDERICK (LST-1184)	1 UH-1H	BLT (ARG BRAVO)
RACINE (LST-1191)		1,130 TROOPS

ARG BRAVO

DUCUQUE (LPD-4)
 FRESNO (LST-1182)

ARG ALFA SCHEDULE

28 JUN-12 JUL UPKEEP SUBIC BAY
 13-15 JUL ENROUTE OKINAWA
 15-21 JUL PHIBLEX OKINAWA

INDIAN OCEAN/PERSIAN GULF DEPLOYMENTS

TASK FORCE 70

8 JULY 1980

EISENHOWER TG 70.9
AIRCRAFT ASSIGNED

23 F-14	4 EA-6B
24 A-7E	10 S-3A
10 A-6E	6 SH-3H
4 KA-6D	3 RH-53
4 E-2C	

SCHEDULE

ON STATION ARABIAN SEA

CONSTELLATION TG 70.4
AIRCRAFT ASSIGNED

24 F-14	4 E-2C
12 A-7E	3 RF-8G
10 A-6E	6 SH-3H
4 KA-6D	10 S-3A
2 EA-3B	1 US-3
	1 C-2

SCHEDULE

ON STATION ARABIAN SEA

MILITARY OPTIONS - AIRCRAFT AND LOCATIONS

GUAM	EUROPE
7 P-3C (HARPOON)	4 B-52H
2 P-3B	4 MC-130 (NOT AAR)
1 EP-3	6 KC-135
3 KC-135	

WEST CONUS OT & E

3 AC-130 (ALL AAR)
3 MC-130 (ALL AAR)
(1 NOT AAR)

HURLBURT

7 AC-130 (NOT AAR)
2 MC-130 (2 NOT AAR)

LANDING FORCE SIXTH FLEET (1,725 USMC PERSONNEL)

SHIPS	AIRCRAFT	TROOPS EMBARKED
GUADALCANAL (LPH-7)	4 CH-53D	32ND MAU
NASHVILLE (LPD-13)	12 CH-46E	1,725 TROOPS
PENSACOLA (LSD-38)	4 AH-1T	
LAMOURE CTY (LST-1194)	2 UH-1N	
BARNSTABLE CTY (LST-1197)		

SCHEDULE

1-5 JUL VISIT SPANISH PORTS
6-11 JUL TUNISIA (TRANCH 7-80)
12-23 JUL ENROUTE KENYA (TENTATIVE)
24-31 JUL AMPHIB EXERCISE KENYA (TENTATIVE)

FLEET MARINE FORCE SEVENTH FLEET (2,848 USMC PERSONNEL)

SHIPS	AIRCRAFT	TROOPS EMBARKED
ARG ALFA	4 CH-53D	31ST MAU (ARG ALFA)
NEW ORLEANS (LPH-11)	12 CH-46F	1,718 TROOPS
VANCOUVER (LPD-2)	4 AH-1T	
FREDERICK (LST-1184)	1 UH-1N	BLT (ARG BRAVO)
RACINE (LST-1191)		1,130 TROOPS
ARG BRAVO		
DUBUQUE (LPD-8)		
FRESNO (LST-1182)		

ARG ALFA SCHEDULE

28 JUN-12 JUL UPKEEP SUBIC BAY
13-15 JUL ENROUTE OKINAWA
15-21 JUL PHIBLEX OKINAWA

~~SECRET~~

INDIAN OCEAN/PERSIAN GULF DEPLOYMENTS

TASK FORCE 70

22 JULY 1980

By Col 2256
Thompson

28-104

EISENHOWER TG 70.9
AIRCRAFT ASSIGNED

23 F-14	4 EA-6B
24 A-7E	10 B-3A
10 A-6E	6 SH-3H
4 KA-6D	3 RH-53
4 E-2C	

SCHEDULE

ENROUTE TO INDIAN OCEAN

CONSTELLATION TG 70.4
AIRCRAFT ASSIGNED

24 F-14	4 E-2C
12 A-7E	3 RF-8G
10 A-6E	6 SH-3H
4 KA-6D	10 B-3A
2 EA-3B	1 US-3
	1 C-2

SCHEDULE

ON STATION ARABIAN SEA

MILITARY OPTIONS - AIRCRAFT AND LOCATIONS

GUAM	EUROPE	---
4 B-52H	4 MC-130 (NOT AAR)	
6 KC-135		

WEST CONUS OT 8 E

~~3 AC-130 (ALL AAR)~~
~~5 MC-130 (1 NOT AAR)~~

HURLBURT

107 AC-130 (5 NOT AAR)
5 MC-130 (7 NOT AAR)

3 MC-130 (ALL AAR)

PACAF A/C

LANDING FORCE SIXTH FLEET (1,725 USMC PERSONNEL)

SHIPS	AIRCRAFT	TROOPS EMBARKED
GUADALCANAL (LPH-7)	4 CH-53D	32ND MAU
NASHVILLE (LPD-13)	12 CH-46E	1,725 TROOPS
PENSACOLA (LSD-38)	4 AH-1T	
LAMOURE CTY (LST-1194)	2 UH-1N	
BARNSTABLE CTY (LST-1197)		

SCHEDULE

12-23 JUL ENROUTE INDIAN OCEAN
24-31 JUL AMPHIB EXERCISE KENYA (TENTATIVE)
1-15 AUG OPS INDIAN OCEAN (TENTATIVE)
16-23 AUG ENROUTE MED (TENTATIVE)

FLEET MARINE FORCE SEVENTH FLEET (2,848 USMC PERSONNEL)

SHIPS	AIRCRAFT	TROOPS EMBARKED
ARG ALFA	4 CH-53D	31ST MAU (ARG ALFA)
NEW ORLEANS (LPH-11)	12 CH-46E	1,718 TROOPS
VANCOUVER (LPD-2)	4 AH-1T	
FREDERICK (LST-1184)	1 UH-1N	BLT (ARG BRAVO)
RACINE (LST-1181)		1,130 TROOPS
ARG BRAVO		
DUBUQUE (LPD-8)		
FRESNO (LST-1182)		

ARG ALFA SCHEDULE

22-23 JUL ENROUTE HONG KONG
24-27 JUL PORT VISIT HONG KONG
28-29 JUL ENROUTE SUBIC BAY
30 JUL-3 AUG UPKEEP SUBIC BAY
4-7 AUG ENROUTE INDIAN OCEAN

~~SECRET~~ - ~~CONFIDENTIAL~~

INDIAN OCEAN/PERSIAN GULF DEPLOYMENTS

TASK FORCE 70

22 AUG 80

28

EISENHOWER TG 70.9	
AIRCRAFT ASSIGNED	
24 F-14	4 E-2C
21 A-7E	4 EA-6B
10 A-6E	7 S-3A
4 KA-6D	6 SH-3H
SCHEDULE	
ON STATION ARABIAN SEA	

MIDWAY TG 70.1	
AIRCRAFT ASSIGNED	
18 F-4	4 EA-6B
16 A-7	3 HF-4B
8 A-6	4 SH-3
3 KA-6	1 C-1
4 E-2B	
SCHEDULE	
ON STATION INDIAN OCEAN	

MILITARY OPTIONS - AIRCRAFT AND LOCATIONS

E

~~CONFIDENTIAL~~

2 P-3C

2 P-3B

1 EP-3

5 KC-135

GUAM

4 B-52H

6 KC-135

EUROPE

4 MC-130 (NOT AAR)

HURLBURT

8 AC-130 (5 NOT AAR)

5 MC-130 (2 NOT AAR)

21 MC-130 (AAR)*

*PAC AF A/C

LANDING FORCE SIXTH FLEET (1,725 USMC PERSONNEL)		
SHIPS	AIRCRAFT	TROOPS EMBARKED
GUADALCANAL (LPH-7)	4 CH-53D	32ND MAU
NASHVILLE (LPD-13)	12 CH-46E	1,725 TROOPS
PENSACOLA (LSD-38)	4 AH-1T	
LAMOURE CTY (LST-1194)	2 UH-1N	
BARNSTABLE CTY (LST-1197)		
SCHEDULE		
22 AUG - 5 SEP	UPKEEP NAPLES	
6 - 14 SEP	PHIBLEX 9-80, MT ROMANO, ITALY	

FLEET MARINE FORCE SEVENTH FLEET (2,848 USMC PERSONNEL)		
SHIPS	AIRCRAFT	TROOPS EMBARKED
ARG ALFA		
NEW ORLEANS (LPH-11)	4 CH-53D	31ST MAU (ARG ALFA)
VANCOUVER (LPD-2)	12 CH-46F	1,718 TROOPS
FREDERICK (LST-1184)	4 AH-1T	BLT (ARG BRAVO)
RACINE (LST-1191)	1 UH-1N	1,130 TROOPS
ARG BRAVO		
DUBUQUE (LPD-8)		
FRESNO (LST-1182)		
ARG ALFA SCHEDULE		
8 AUG - TBD		INDIAN OCEAN OPS

~~CONFIDENTIAL~~
~~SECRET~~

INDIAN OCEAN/PERSIAN GULF DEPLOYMENTS

TASK FORCE 70
29 AUG 80

EISENHOWER TG 70.9 AIRCRAFT ASSIGNED

24 F-14	4 E-2C
21 A-7E	4 EA-6B
10 A-6E	10 B-3A
4 KA-6D	6 SH-3H
	1 US-3A

SCHEDULE

ON STATION ARABIAN SEA

MIDWAY TG 70.1 AIRCRAFT ASSIGNED

18 F-4	4 EA-6B
16 A-7	3 RF-4B
8 A-6	4 SH-3
3 KA-6	1 C-2
4 E-2B	

SCHEDULE

ON STATION ARABIAN SEA

MILITARY OPTIONS - AIRCRAFT LOCATIONS

GUAM

4 B-52H
6 KC-135

EUROPE

4 MC-130 (NOT AAR)

HURLBURT

8 AC-133 (5 NOT AAR)
5 MC-133 (2 NOT AAR)
3 MC-133 (AAR)*
*PAC AF A/C

LANDING FORCE SIXTH FLEET (1,725 USMC PERSONNEL)

SHIPS	AIRCRAFT	TROOPS EMBARKED
JADALCANAL (LPH-7)	4 CH-53D	32ND MAU
NASHVILLE (LPD-13)	12 CH-46E	1,725 TROOPS
PENSACOLA (LSD-38)	4 AH-1T	
LAMOURE CTY (LST-1184)	2 UH-1N	
BARNSTABLE CTY (LST-1187)		

SCHEDULE

22 AUG - 5 SEP	UPKEEP NAPLES
6-14 SEP	PHIBLEX 9-80, MT ROMANO, ITALY
15-16 SEP	ENROUTE TOULON, FRANCE
17-28 SEP	UPKEEP TOULON
30 SEP-10 OCT	TRAINING ACHORAGE, ASINARA BAY, ITALY

FLEET MARINE FORCE SEVENTH FLEET (2,915 USMC PERSONNEL)

SHIPS	AIRCRAFT	TROOPS EMBARKED
ARG ALFA		
NEW ORLEANS (LPH-11)	4 CH-53D	31ST MAU (ARG ALFA)
VANCOUVER (LPD-2)	12 CH-46F	1,718 TROOPS
FREDERICK (LST-1184)	4 AH-1T	BLT (ARG BRAVO)
RACINE (LST-1181)	1 UH-1N	1,187 TROOPS

ARG ALFA SCHEDULE

ARG BRAVO		
DUBUQUE (LPD-8)	29 AUG - 3 SEP	ENROUTE MOMBASA, KENYA
FRESNO (LST-1182)	4-17 SEP	VISIT MOMBASA
	8-12 SEP	ENROUTE DIEGO GARCIA
	13-17 SEP	RAU, DIEGO GARCIA
	18-26 SEP	ENROUTE AUSTRALIA
	27 SEP - 1 OCT	VISIT PERTH, AUSTRALIA

~~CONFIDENTIAL~~ ~~SECRET~~

~~SECRET~~

INDIAN OCEAN/PERSIAN GULF DEPLOYMENTS

TASK FORCE 70

12 SEP 80

EISENHOWER TG 70.9 AIRCRAFT ASSIGNED

24 F-14	4 E-2C
21 A-7E	4 EA-6B
10 A-6E	10 B-3A
4 KA-6D	6 SH-3H
	1 US-3A

SCHEDULE

ENROUTE ARABIAN SEA

MIDWAY TG 70.1 AIRCRAFT ASSIGNED

18 F-4	4 EA-6B
16 A-7	3 RF-4B
8 A-6	4 SH-3
3 KA-6	1 C-2
4 E-2B	

SCHEDULE

ON STATION ARABIAN SEA

MILITARY OPTIONS - AIRCRAFT LOCATIONS

GUAM

4 B-52H
6 KC-135

EUROPE

4 MC-130 (NOT AAR)

HURLBURT

10 AC-130 (5 NOT AAR)
5 MC-130 (3 NOT AAR)
3 MC-130 (AAR)*

*PAC AF A/C

4 F-3C
2 F-3B
4 EA-3B
1 EP-3E
1 US-3A
4 B3A
4 KC-135

LANDING FORCE SIXTH FLEET (1,725 USMC PERSONNEL)

SHIPS	AIRCRAFT	TROOPS EMBARKED
GUADALCANAL (LPH-7)	4 CH-53D	32ND MAU
NASHVILLE (LPD-13)	12 CH-46E	1,725 TROOPS
PENSACOLA (LSD-38)	4 AH-1T	
LAMOURE CTY (LST-1184)	2 UH-1N	
BARNSTABLE CTY (LST-1197)		

SCHEDULE

9-14 SEP	PHIBLEX 9-80, MT ROMANO, ITALY
15-16 SEP	ENROUTE TOULON, FRANCE
17-28 SEP	UPKEEP TOULON
30 SEP-10 OCT	TRAINING ANCHORAGE, ASINARA BAY, ITALY

FLEET MARINE FORCE SEVENTH FLEET (2,915 USMC PERSONNEL)

SHIPS	AIRCRAFT	TROOPS EMBARKED
ARG ALFA		
NEW ORLEANS (LPH-11)	4 CH-53D	31ST MAU (ARG ALFA)
VANCOUVER (LPD-2)	12 CH-46F	1,718 TROOPS
FREDERICK (LST-1184)	4 AH-1T	BLT (ARG BRAVO)
RACINE (LST-1191)	1 UH-1N	1,197 TROOPS
ARG BRAVO		

ARG ALFA SCHEDULE

DUBUQUE (LPD-8)	8-11 SEP	PHIB OPS KENYA
FRESNO (LST-1182)	12-17 SEP	ENROUTE DIEGO GARCIA
	18 SEP	FUEL STOP, DIEGO GARCIA
	19-26 SEP	ENROUTE AUSTRALIA
	27 SEP-1 OCT	VISIT AUSTRALIAN PORTS
	2-9 OCT	PHIBLEX NW AUSTRALIA

~~CONFIDENTIAL SECRET~~

~~CONFIDENTIAL~~
SECRET

INDIAN OCEAN/PERSIAN GULF DEPLOYMENTS

TASK FORCE 70

~~29 AUG 80~~

5 SEP 80

EISENHOWER TG 70.9 AIRCRAFT ASSIGNED

24 F-14	4 E-2C
21 A-7E	4 EA-6B
10 A-6E	10 B-5A
4 KA-6D	6 BH-3H
	1 UB-3A

SCHEDULE

ON STATION ARABIAN SEA

MIDWAY TG 70.1 AIRCRAFT ASSIGNED

18 F-4	4 EA-6B
16 A-7	3 RF-4B
8 A-6	4 BH-3
3 KA-6	1 C-2
4 E-2B	

SCHEDULE

ON STATION ARABIAN SEA

MILITARY OPTIONS - AIRCRAFT LOCATIONS

GUAM

4 B-52H
6 KC-135

EUROPE

4 MC-130 (NOT AAR)

HURLBURT

8 AC-133 (5 NOT AAR)
3 MC-130 (2 NOT AAR)
2 ~~MC-130~~ MC-130 (AAR)*
*PAC AF A/C

LANDING FORCE SIXTH FLEET (1,725 USMC PERSONNEL)

SHIPS	AIRCRAFT	TROOPS EMBARKED
GUADALCANAL (LPH-7)	4 CH-53D	32ND MAU
NASHVILLE (LPD-13)	12 CH-46E	1,725 TROOPS
PENSACOLA (LSD-38)	4 AH-1T	
LAMOURE CTY (LST-1184)	2 UH-1H	
BARNSTABLE CTY (LST-1187)		

SCHEDULE

22 AUG - 2 SEP	UPKEEP NAPLES
6-14 SEP	PHIBLEX 9-80, MT ROMANO, ITALY
15-16 SEP	ENROUTE TOULON, FRANCE
17-26 SEP	UPKEEP TOULON
30 SEP-10 OCT	TRAINING ACHORAGE, ASINARA BAY, ITALY

FLEET MARINE FORCE SEVENTH FLEET (2,915 USMC PERSONNEL)

SHIPS	AIRCRAFT	TROOPS EMBARKED
ARG ALFA		
NEW ORLEANS (LPH-11)	4 CH-53D	31ST MAU (ARG ALFA)
VANCOUVER (LPD-2)	12 CH-46E*	1,718 TROOPS
FREDERICK (LST-1184)	4 AH-1T	BLT (ARG BRAVO)
RACINE (LST-1181)	1 UH-1H	1,197 TROOPS
ARG BRAVO		
DUBUQUE (LPD-8)		
FRESNO (LST-1182)		

ARG ALFA SCHEDULE

22 AUG - 2 SEP	ENROUTE MOMBASA, KENYA
4-17 SEP	VISIT MOMBASA
6-12 SEP	ENROUTE DIEGO GARCIA
13-17 SEP	RAU, DIEGO GARCIA
18-26 SEP	ENROUTE AUSTRALIA
27 SEP - 1 OCT	VISIT PERTH, AUSTRALIA

~~CONFIDENTIAL~~
SECRET

RECEIVED

CONFIDENTIAL

J-17

15 MAY 1952 11 43

VZCZCNCCL982

J31NMC

ACTION

5452

DIST:

CJCS(102) CJCS DJS 4325(101) J31(101) J31(101) J31(101)

J31NMC NTOS 4200E(102) SUCDEP(102) ASD(101) ASD(101) ASD(101)

DIA: DIA(10) NMIC FILE

(046)

TRANSIT/1301425/1301140/001210R130117

DE: OICMNTA 21200 1301095

ZNY CCCCC

P 130109Z MAY 52

FM: [REDACTED]

TO: RUMRAAC/CTE SEVEN TWO PT THREE

INFO: RUEHC/SECSTATE WASHDC

RUEXJCS/JCS WASHDC

RUEKJCS/SECDEF WASHDC

RUEWJCS/CNO WASHDC

RUEHQA/CINCPAC HONOLULU HI

RUEHRA/CINCPACFLT PEARL HARBOR HI

RUEHBA/CINCPACFLT LONDON UK

RUEHAAZUSCINCPAC WASHINGTON DC

RUEHQA/COMSEVENTHFLT

RUEHQA/COMEIGHTHFLT

RUEHQA/COMNINTCOM

RUEHQA/COMSIXTHFLT

RUEHQA/COMSEVENTHFLT

RUEHQA/COMEIGHTHFLT

RUEHQA/COMNINTCOM

RUEHQA/COMSEVENTHFLT

RUEHQA/COMEIGHTHFLT

BT

~~CONFIDENTIAL~~

SUBJ: P-3 RO24 OPS OUT OF [REDACTED]

1. (C) THE FOLLOWING WAS PASSED TO OAD FROM [REDACTED] OAD

ON 14 MAY 52: (1) EFFECTIVE IMMEDIATELY ON MORE THAN

ONE P-3 ALLOWED TO [REDACTED] AT ANY ONE TIME (2)

CROSSOVERS, EVEN INVOLVING UNSERVICABILITY, ARE TO BE

ARRANGED TO COMPLY WITH THIS RULING. (NOTE: THIS

RULING DOES NOT REPEAT AND HOWEVER APPLY TO POSSIBLE

PAGE 1

~~CONFIDENTIAL~~

011320H

Classified by
DDO NMCC

4 Aug 92

Declassify on: OADR

CONFIDENTIAL

PAGE 2

~~CONFIDENTIAL~~

14579

ADDITIONAL P-3 ACFT WITH MAINT PERS/PARTS MOVEMENT
 REQUIREMENTS TO SUPPORT PRESENTLY DOWNED A-1.
 2. (X)ADDRESSEE REQUESTED TO LOOK AT POSSIBLE NEED FOR
 SKEW REVISION FOR FUTURE P-3 ACFT OPS WHERE INCOMING
 OUTGOING ACFT ARRIVAL/DEPARTURE TIMES MAY OVERLAP TO
 AVOID VIOLATION OF NEW RULING. (YII ORIG PERLS DURING
 ACFT REQUIREMENTS SUCH AS PRESENT SITUATION WITH HARD-
 DOWN P-3 CAN BE NEGOTIATED ON CASE BY CASE BASIS).
 DECL: 14 MAY 60

BT
 #1009
 ANNOTES
 CEV

PAGE 2
 1511407

~~CONFIDENTIAL~~

1511407

11 60

5-18

04-02

15

SECRET (XX) SECRET (XX) USOP (15) DIA
DIA (15) NPTC (15) FRODO (15) NPTC (15) ARMY (15) NPTC

1370336/1370351/00211070513/0059

1370336

STATE ZZ4

RUMAN

NO 0403 1370336

STATE ZZ4

STATE WASHDC

EMBASSY

EMBASSY IMMEDIATE 0417

EMBASSY IMMEDIATE 0417

STATE 120000

STATE 05/15/78

WARR, OK, US, X0

US FACILITIES AGREEMENT

ENTIRE TEXT

THE DEPUTY SECRETARY HAS APPROVED THE UNCLASSIFIED AND
REFERENDUM EXCHANGE OF VOICES AND UNCLASSIFIED AGREEMENT
IMPLEMENTATION OF THE AGREEMENT NOTES AS INITIALED
ON APRIL 11, 1978. THE NOTES TO BE SIGNED TO
SIGNATURE OF THESE TWO DOCUMENTS. YOU SHOULD
WOULD PREFER TO MOVE MORE QUICKLY. NO RECORDS TO YOU DISCUSS
TIMING OF SIGNATURE IS...

AGREEMENT...
CONFIDENTIAL...
RE REVIEW...

Classified by
DDO NMC
4 Aug 92
Declassify on: OADR

~~CONFIDENTIAL~~

E

E

E

G

... THAT THE AIDED ... PART OF THE AGREEMENT, BUT ... DISCUSSIONS THAT TOOK PLACE BETWEEN ... SUBJECTS CONCERNED.

... AGREEMENT IN IMPLEMENTATION ... ACCORDANCE WITH 11 FAR ... ORIGINAL OF ... U.S. NOTE SHOULD ... ATTENTION OF THE ... ORIGINAL ... IMPLEMENTATION AND A COPY OF ... IMPLEMENTATION ... CONGRESS PURSUANT TO THE ...

BY
#1483
ANNOTES

Classified By: ~~SECRET~~
Declassified on: ~~OADR~~

~~CONFIDENTIAL~~

1483717

~~CONFIDENTIAL~~

VEZ20AC118
121800
ACTION

DISTR

FILSVC DUCS (2) JCN DUCS (2) JCN DUCS (2)
JCN DUCS (2) JCN DUCS (2) JCN DUCS (2)

TRANSIT/121800/121800/121800/121800/121800
DE RUCS (2) JCN DUCS (2) JCN DUCS (2)
ZNY 2658 28H
P 121817Z MAY 68
FM AMEMBRY [REDACTED]
TO RUCS/SECDEF WASHDC WPTDPT
INFO RUCS/AF/ETHRAC
RUCS/AF/INCE/AF/ETHRAC
RUCS/AF/COM/AF/ETHRAC
RUCS/AF/COM/AF/ETHRAC
RUCS/AF/COM/AF/ETHRAC
RUCS/AF/COM/AF/ETHRAC
RUCS/AF/COM/AF/ETHRAC

PK

SUBJECT: [REDACTED]

WHILE SMALL LOW PROFILE UNMANNED AIR AND SEA EXERCISES MIGHT BE CONSIDERED AS A
I DO NOT BELIEVE IT WOULD BE WORTH THE EFFORT
TO BRING SUCH EXERCISES UNDER THE
SOME PUBLICITY WOULD BE LIKELY TO LEAD TO
EXERCISES ARE KEPT LOW PROFILE AND
ACCUSED OF PARTICIPATING IN A RESTRICTED AREA

*Classified by
JCN DUCS 4 Aug 92
Declassify on OADR*

... HAVE LEARNED FROM DAYS OF ROADHEAD PART TO
... IS POLITICAL DYNAMITE FOR ANY
... TO APPEAR TO PARTICIPATE IN ROADHEAD MILITARY
... SUCH ACTIONS EXPOSE THEM TO EMOTIONAL BUT
... PROPAGANDA ATTACKS ON GROUNDS THAT THEY ARE
... SELLING OUT TO THE IMPERIALISTS" AND OPPOSING THE
... PROPOSAL AS OUTLINED WOULD GIVE TO THE
... MOST OF BOTH WORLDS. IT WOULD ENTAIL THE
... DISADVANTAGES OF EXPOSING [REDACTED] TO CRITICISM FROM THE
... STATES FOR PARTICIPATION IN ROADHEAD MILITARY
... WITHOUT THE ACTUAL TRAINING ADVANTAGES OF
... MULTILATERAL EXERCISES.

... RECOMMEND THAT [REDACTED] BE EXCLUDED FROM
... TO HOLD BILATERAL AND TRILATERAL JOINT EXERCISES
... FORENSIC WEAPONS AND A ROUTE TO
... THROUGH A STRICTLY CONTROLLED BASIS.

E
G

~~CONFIDENTIAL~~

J-20

12 MAY 1980 09 58

NMCC-CWQ

VZCZCNC083
J31NMCC
ACTION

~~SECRET~~

ZPDY

47265

TERMSVC DJS(01)
DISTR
FILEBVC CJCS(02), CJCS SJCS(01), DCCDIV(01) J31NMCC NIDS
SECDEF(07) SECDEF: USOP(15) FILE
(027)

ADV DISTR
J31NMCC
TRANSIT/133095Z/133095Z/000106TOR133095Z

THIS MSG BEING SVCD BY JCSMC

DE RUBNAAA #1746 133095Z
ZNY 88888
Z 112145Z MAY 80
FM USCINCEUR VAHNINGEN GE //ECJ3//
TO RUEKJCS/JCS WASH DC //DJS//
RUDONBA/CINCUSNAVEUR LONDON UK
RHFRAAB/HQ USAFE RAMSTEIN AB GE
RUPDAAA/CINCUSAREUR HEIDELBURG GE
RUGMMT/USDAO [REDACTED]
INFO RUEADWD/CSA WASH DC
RUENAAA/CNO WASH DC
RUEAHQA/CSAF WASH DC
RUEACMC/CMC WASH DC
RUHQHQA/CINCPAC HONOLULU HI
RHHMBRA/CINCPACFLT PEARL HARBOR HI
RUDONBA/COMCOGARD ACTEUR LONDON UK
RUDORRA/USNMR SHAPE BELGIUM
BT

E

~~SECRET~~ ECJ3 10002
SUBJ [REDACTED] COASTAL SURVEILLANCE TECHNICAL SURVEY (U)
JCS 121526Z MAY 80 PASEP

E

1. (U) REF A DIRECTED USEUCOM TAKE RESPONSIBILITY FOR CONDUCT
OF A COASTAL SURVEILLANCE TECHNICAL SURVEY OF [REDACTED] THE SURVEY
TEAM IS TO ARRIVE IN [REDACTED] FLT 17 MAY 1980 AND WILL REMAIN IN
COUNTRY FOR APPROXIMATELY 12 DAYS.

E

2. (U) FOR CINCUSNAVEUR:
A. (U) REQ TAKE REF A FOR ACTION AS THE EXECUTIVE AGENT
FOR USCINCEUR FOR ACCOMPLISHMENT OF ASSIGNED TASKS.

PAGE 1

~~SECRET~~

00011011

~~CONFIDENTIAL~~

Classified by DDO NMCC
4 Aug 92
Declassify on: OADR
Downgraded to CW
by DDO NMCC
4 Aug 92

~~CONFIDENTIAL~~

PAGE 2

~~SECRET~~

47265

5. (U) ASSEMBLE TECHNICAL SURVEY TEAM. PROVIDE TEAM CHIEF AND USN 04/25 RADAR SPECIALIST. ARRANGE WITH COMCOGARD ACTEUR FOR COAST GUARD REP. CINCUSAFE AND CINCUSAREUR WILL PROVIDE USAF/USA 04/25 TEAM MEMBERS SPECIFIED IN PARA 5 REF A. CDR [REDACTED] USN [REDACTED] HQ USEUCOM AND CAPT [REDACTED] USN, CINCOPAC WILL BE ADDITIONAL MEMBERS OF THE TEAM.

C. (U) ARRANGE FOR TRAVEL ARRANGEMENTS COUNTRY CLEARANCES AND VISAS. UNIFORMS WILL NOT BE WORN.

D. (U) THIS HQ WILL PROVIDE THREAT BRIEFINGS AND ASSESSMENTS FOR THE TEAM AT HQ USEUCOM PRIOR TO DEPARTURE, AT TIME AND DATE SELECTED BY NAVEUR; REQ ADVISE DATE.

E. (U) WITHIN 10 WORKING DAYS AFTER RETURN, THE TEM CHIEF WILL SUBMIT A DRAFT REPORT TO DCINCEUR FOR APPROVAL AND SUBSEQUENT TRANSMISSION TO JCS. TEAM CHIEF WILL BRIEF DCINCEUR CONCURRENT WITH SUBMISSION OF THE DRAFT REPORT AND WILL BE PREPARED TO ASSIST WITH REPORT REVIEW IN WASHINGTON IF REQUIRED.

F. (U) DURLAUGH ALCON. ADVISE THIS HQ IF ADDITIONAL ASSISTANCE OR GUIDANCE IS REQUIRED.

3. (U) FOR CINCUSAFE: REQUEST YOU PROVIDE TO CINCUSNAVEUR ONE OFFICER, GRADE O-4 OR O-5, WITH EXPERIENCE IN AERIAL RECONNAISSANCE AND RADAR TO SERVE AS A MEMBER OF THE TEAM.

4. (U) FOR CINCUSAREUR: REQUEST YOU PROVIDE TO CINCUSNAVEUR ONE OFFICER, GRADE O-4 OR O-5, WITH EXPERIENCE IN CORPS LEVEL COMMUNICATIONS SYSTEMS AND INTERSERVICE INTERFACE TO SERVE AS

5. (U) FOR USDAO [REDACTED] IN ORDER TO ENSURE DIRECTED ARRIVAL TIME ON 17 MAY IS MET, REQUEST ARRANGE FOR COUNTRY CLEARANCE FOR COASTAL TECHNICAL SURVEY TEAM, HOTEL RESERVATIONS AND ESSENTIAL PRECOORDINATION WITH COUNTRY TEAM AND GOVERNMENT OF [REDACTED] NAMES AND SPECIFIC TRANSPORT ARRANGEMENTS WILL BE PROVIDED BY CINCUSNAVEUR AS SOON AS AVAILABLE. REQ MAKE ARRANGEMENTS FOR WORKING SPACE, CLERICAL SUPPORT, AND IN-COUNTRY VISITS AS NECESSARY. ADVISE IF AIRPORT VISAS AVAILABLE.

6. (U) FOR OJCS:

A. (U) UNLESS DIRECTED OTHERWISE INTEND TO MAKE FOLLOWING MODIFICATIONS TO DIRECTIONS IN REF A.

PAGE 2

~~SECRET~~

00011011

~~CONFIDENTIAL~~

~~CONFIDENTIAL~~

PAGE 3

~~SECRET~~

47265

(1) (S) PARA 8. CHANGE TO READ: QUOTE THE TEAM CHIEF WILL BE THE REPRESENTATIVE OF USCINCEUR AND WILL BE UNDER THE DIRECTION OF CINCUSNAVEUR, ACTING AS THE EXECUTIVE AGENT FOR USCINCEUR, ON ALL MATTERS SET FORTH HEREIN. UNQUOTE.

E WORKING DAYS AFTER RETURNING, THE TEAM CHIEF WILL SUBMIT A DRAFT REPORT TO USCINCEUR FOR APPROVAL. USCINCEUR WILL SUBMIT A DRAFT REPORT THROUGH JCS TO THE SECRETARY OF DEFENSE FOR APPROPRIATE INTERAGENCY REVIEW. THE REPORT IS TO BE STRUCTURED SO AS TO PROVIDE THE BASIS FOR USG DECISIONS REGARDING U.S. ASSISTANCE TO ENHANCE [REDACTED] COASTAL SURVEILLANCE CAPABILITY.

B. (U) REF A, PARA 7, REQUEST PROVIDE OASD/ISA AND JCS PREBRIEF TO THE SURVEY TEAM ON 14 OR 15 MAY AT HOUSECOM. EXACT DATE AND TIMING OF BRIEF TO BE PROVIDED BY CINCUSNAVEUR.

C. (U) REF A STATES THE TEAM WILL BE FINANCED BY THE USG USING NORMAL O&M FUNDS OF THE AGENCIES WHICH PROVIDE THE SURVEY PERSONNEL. ACCORDINGLY, REQUEST FUND CITES BE PROVIDED BY CSAF, CSA, CNO, AND CMTD USCG FOR INCLUSION IN APPROPRIATE TEAM MEMBER ORDERS. HQ USEUCOM AND COMPONENTS DO NOT HAVE ADDITIONAL TDY FUNDS TO SUPPORT THIS UNPROGRAMMED REQUIREMENT.

BT

#1766

ANNOTES

ORIG MSG NOT IDENTIFIED IN DATA BASE

TERMSVC SVC FOR DOWNGRADING AND IF COMPLETE MSG

REF IS JB OUT 5472

CLH

PAGE 3

NNNN

120958Z

~~SECRET~~

00011011

~~CONFIDENTIAL~~

J-27

HOSTAGE STATUS

~~CONFIDENTIAL~~

STATUS QUO

TRIALS

E

US OBJECTIVES

← SHOW OF FORCE →

SHORT TERM	LONG TERM	CONTINUE RESCUE PLANNING (LOCATE HOSTAGES)	RESCUE MISSION	PSYCHOLOGICAL CAMPAIGN	RESCUE MISSION	INC. NAVAL FORCES IN R.G./S.O.	INC. TROOP IN REFLD	SR-71 ORFELT	B-52 TD-
RELEASE OF HOSTAGES		+	+	+	+	0	0	0	0
MAINTAIN WESTERN ACCESS TO OIL		0	0	+	0	+	+	0	+
PROMOTE SWIFT ENFORCEMENT INTO IRAN		0	-	0	-	0	0	0	0
MAINTAIN INDEPENDENCE OF IRANIAN GOVT		0	0	+	0	0	0	0	0
MAINTAIN RELATIONS WITH FRIENDLY PG STATES		0	0	+	0	+	-	0	-
MAINTAIN RELATION WITH WESTERN ALLIES		0	+	0	+	+	+	0	-
RETAIN INTEGRITY OF IRANIAN NATION		0	0	0	0	0	0	0	0
NEUTRALISE SWIFT INFLUENCE IN PG/IRAN		0	-	+	-	+	+	0	+
PROMOTE STABILITY IN THE PG & LITTORAL STATES		0	0	0	0	+	-	0	-
ESTABLISH A PRO-WESTERN GOVT IN IRAN		0	-	+	-	0	0	0	0
CREATE FAVORABLE WORLD OPINION FOR US ACTIONS		0	0	+	0	+	0	0	-

KEY:

- + enhances objective
- adverse impact on objective
- 0 no effect

Classified by 880, NMCC

Declassify on OADR 4 AUG 92

Downgraded to Confidential

by 880, NMCC 4 Aug 92

* ADDITIONAL TIME COULD BE PROVIDED FOR NOTICE TO MARINERS.

~~CONFIDENTIAL~~

OPTIONS -

EXECUTIONS

PRE-EXECUTION



MEASURED FORCE EMPLOYMENT ACTIONS

ASST NO	QUARANTINE	US SIGNAL OF RESOLVE (e.g. B-52 SORTIE; THREAT SHOTS)	RESCUE MISSION	MINING HARBORS	INTERDICT ROAD/RAIL RESUPPLY	STRIKE ELECTRICAL POWER SYSTEMS/ GRID	STRIKE COMM- MUNICATION NETS	STRIKE RAIL	STRIKE BRIDGE INFRASTRUCTURE POINTS	ATTACK REFINERIES	ATTACK AIRFIELD/ MILITARY CONCENTRATIONS/ AIRCRAFT	Establish Command and Logistics
ITE	19 HRS #	12 HRS	TBD	24-39 HOURS	TBD	48 HOURS	TBD	TBD	TBD	TBD	TBD	TBD
	+	-	+	+	-	-	-	-	-	-	-	+
	0	-	0	0	-	-	-	-	-	-	-	+
	0	-	0	-	-	-	-	-	-	-	-	+
	0	-	+	0	-	-	-	-	-	-	-	+
	-	-	+	-	-	+	-	-	-	-	-	+
	0	0	+	+	0	+	-	-	-	-	-	0
	-	0	0	-	-	-	-	-	-	-	-	-
	-	-	0	-	-	-	-	-	-	-	-	-
	-	-	+	-	-	-	-	-	-	-	-	-
	0	-	+	0	-	-	-	-	-	-	-	+
	-	-	+	+	+	+	+	+	+	+	+	+

ACT OF
WAR

ACTS OF WAR

* WILL REQUIRE CONSIDERABLE US DOMESTIC AND CONGRESSIONAL SUPPORT FORS DIPLOMATIC AND MILITARY SANCTIONS

~~TOP SECRET~~ ~~SENSITIVE~~

Classified By: JCS
Declassify On: OADR



~~SECRET~~

DEPARTMENT OF THE NAVY
OFFICE OF THE CHIEF OF NAVAL OPERATIONS
WASHINGTON, D.C. 20350

J-30

OP-605E7/A5777-11
Ser 60/S414805
24 JUN 1981

~~SECRET~~

MEMORANDUM FOR THE DIRECTOR OF OPERATIONS, OJCS

Subj: Review and Analysis of the Joint Task Force Capability Review (U)

Ref: (a) Your memo dtd 29 May 1981

A

1. ~~Let~~ As requested in reference (a), a review of subject report has been conducted. The study is a valuable source document for lessons learned, the primary value of which probably lies at the unified command level and with the [redacted] who could then ensure selective distribution/tasking of applicable portions of the review to subordinate forces as required. The document also has wide ranging implications for the Services regarding funding, tactics and operational assets. For this reason it would be premature, at this time, to treat the report as a joint document to be used as a basis for formulating a plan of action and milestones for the Services.

2. ^(U) ~~Let~~ A select review of the report by the SOAP, or selected members, is not deemed necessary at this time.

A

3. ~~Let~~ With the exigency of the Iranian hostage incident behind us, the unified commands and the [redacted] should be allowed to review the document and take appropriate action within established Service/JCS channels. Beyond that, the best way to retain the valuable expertise, gleaned from the Iranian hostage rescue experience, is by the [redacted] participation with the CINCs in the JCS Directed/Coordinated Exercise Program and frequent reinforcement of counterterrorist perishable skills by training conducted on a unit level.

S. R. FOLEY, JR.
Vice Admiral, U.S. Navy
Deputy Chief of Naval Operations
(Plans, Policy and Operations)

Copy to:
LtGen OTIS, USA
LtGen MILLER, USMC
LtGEN O'Malley, USAF

~~SECRET~~

~~SECRET~~
SECRET



~~SECRET~~

DEPARTMENT OF THE NAVY
HEADQUARTERS, UNITED STATES MARINE CORPS
WASHINGTON, D.C. 20380

(J-31)
~~SECRET~~
IN REPLY REFER TO
POC11:WRM:hwm
22 JUN 1981

22 Jun 81
6
- 9 J-33

SECRET-SENSITIVE

MEMORANDUM FOR THE DIRECTOR OF OPERATIONS, OJCS

Subj: Review and Analysis of the Joint Task Force Capability Review (11 May 1981 Report by MG James B. VAUGHT, USA) (U)

1. (U) (S) The Joint Task Force (JTF) Capabilities Review was forwarded to the J-3 by DJSM 901-81, 15 May 1981, for review and analysis, and preparation of a briefing for the Operations Deputies. Your Memorandum to the Service Operations Deputies, 29 May 1981, further forwarded portions of this tasking to the Services to assist in briefing preparation.

2. (U) (S) I am concerned that you may infer that the Services have thoroughly reviewed and concurred in this report. Such is not the case. There is a breadth and depth of material herein that must receive detailed evaluation. Many proposals and/or recommendations could result in changes or additions to tactics or doctrine, and could have significant fiscal impact on the Services. The report directly affects Service training and administrative responsibilities.

3. (U) (S) I am impressed with the document and feel that many of the advancements made by the JTF can provide valuable improvements in military capabilities, both in conventional as well as special operations applications. I am, however, concerned that the close hold nature of this report might stifle access to valuable lessons learned. In my view this report should be sanitized to remove its connection to the mission of the JTF, and then staffed to the responsible Joint Staff Directorates, and/or responsible Services, as appropriate for full review and initiation, by their own programming establishments, of those actions warranted.

4. (U) (S) I do not feel that this report, in its present form, should be considered for joint action as a joint document. Taskings that were given to the JTF under a nationally significant priority for a specific mission should not necessarily be continued with the same impetus once the mission has been resolved. Service responsibilities must be handled within established procedures.

A 5. (U) (S) It would be valuable to have the [redacted] conduct an independent review of this report to be retained as a reference. I do not feel that SOAP review is warranted.

~~SECRET~~

~~SECRET SENSITIVE~~

Classified by: Dir, J-3
Declassify on: 12 Jun 2001

~~SECRET~~
~~SECRET SENSITIVE~~

~~SECRET SENSITIVE~~

~~SECRET~~
FOCI:WRM:hwm
22 JUN 1981

Subj: Review and Analysis of the Joint Task Force Capability
Review (11 May 1981 Report by MG James B. VAUGHT, USA) (U)

A 6. (S) It has been a full quarter since the last [redacted] report to the CJCS. This briefing period could provide a good opportunity to update the Operations Deputies on the status, readiness, and capabilities of the [redacted] and the major problems yet awaiting resolution.

J. H. Miller
J. H. MILLER

Lieutenant General, U. S. Marine Corps
Deputy Chief of Staff for Plans, Policies and Operations

Copy to:
DC/S, O&P, DA
DCNO (PP&O), DON
DC/S, OP&R, DAF

~~SECRET~~
~~SECRET SENSITIVE~~
~~SENSITIVE~~

J 122

This certificate will acknowledge that I have been briefed on Project HOBO

I understand that this briefing has included information affecting the national defense of the United States within the meaning of the Espionage Laws, Sections 793 and 794, Title 18, U.S.C., and that its transmission or revelation in any manner to an unauthorized person is prohibited by law. I therefore affirm that I will not discuss or divulge the information contained in the briefing with anyone except those whom I have determined are cleared for access to this information.

The primary subjects to be protected are:

- a. The fact that this program was initiated or completed.
- b. The detail of any concept which was considered or developed.
- c. Lists of personnel, facilities, other special assets involved in these projects.

I understand that this certificate remains in effect until a formal debriefing.

(Date)

(Signature)

(Name - Print or Type)

(Printed Name & Grade of Person conducting briefing)

(Title, Grade, SSN)

(Organization/Staff Section)

(Signature)

(Service - USN/USA/USAF/USMC/CIV)

(Organization)

Declassified by
DDONMCC
4 Aug 92
Classified By: *JCS*
Declassified ON: *OADR*

G Access to PROJECT HOBO is authorized on a strict need-to-know basis. A need-to-know exists only when access is essential to a person for the performance of his official duties. No person shall be deemed to have a need-to-know solely by virtue of rank, title, or position. It has been determined by the Project Officer, COL Robert [REDACTED] USA, extension 73455, that you have a need-to-know for access to this project. This officer has been charged by the Chairman Joint Chiefs of Staff, to be the sole authority for determining need-to-know for this project.

You may not of your own authority, regardless of your rank or position, grant access to this project to any other person without prior approval of the above project officer. Any such access approved by the above authorities will only become effective after an individual is formally indoctrinated by this office. If for any reason any person not formally authorized access to this information is afforded such access, that person will be required to execute an "Inadvertent Disclosure Security Acknowledgement" if that will not aggravate the compromise. A full report of the circumstances and degree of this disclosure will be submitted to the project officers ASAP in all cases. DIA will conduct any required security investigation

The subjects to be protected by this security compartment are:

- a. The fact that this program was initiated or completed.
- b. The details of any concept which was considered or developed.
- c. Lists of personnel, facilities, and other special assets involved in the project.

The provisions of Public Law Title 18, Sections 793 and 794 are applicable to the material contained in this security compartment.

Section 793 - Gathering, transmitting or losing defense information

Section 794 - Gathering or delivering defense information to aid foreign governments.

Both Sections provide for imprisonment of up to TEN Years and fines of \$10,000 upon conviction, for individuals who willfully disclose or compromise information to unauthorized persons. Copies of Sections 793 and 794 are available for your review.

Access rosters for PROJECT HOBO will be maintained by J-3 (SOD). Verification or certification of an individual authorized access to the project will be accomplished in all cases by calling J-3, SOD, Ext OX7-3455. You may ask what SOD access an individual is authorized. You will be advised that the individual is authorized.

Document control and storage procedures must abide by normal sensitive compartmented information (SCI) or collateral security standards depending on the actual classification assigned to the material. Project material should be stored only in designated containers within areas accredited for the appropriate classification of the material.

TABLE OF CONTENTS

Foreword

Table of Contents

Glossary

Overview:

General

Oversight of the Joint Task Force

Budgetary Support of the JTF

Service Focal Points

~~(S)~~ A. Operations, General:

1. Overview

2. Night Vision Devices - Acquired & Issued

3. C-5A/Tactical Helicopter Transportability - Optimum Loading Plan Revised

4. OH-58/C-130 Helicopter Combat Loading - New Approach Reduces Times by 75% (C)

A 5. ~~██████████~~ OH-58 Loading in C-130/C-141 Improved

6. H-53/C-5 Helicopter Combat Loading - Offload Time Reduced by 50% (C)

7. UH-60/C-5A Transport/Offload Testing

8. UH-60 Shipboard Operations - Compatibility Evaluated, Employment Options Expanded

A,B 9. UH-60/CH-47R/HH-53H Compatibility ~~██████████~~
~~██████████~~ Evaluated (C)

10. Ground-to-Air Personnel Extraction - Improved System Evaluated

B. Ground Operations:

1. General - Helicopter Interface Refined

2. Airfield Seizure - Capability Developed to Quickly Seize and Hold an Airfield in Total Darkness (S)

3. Urban Targets - Urban Guerrilla Tactics Improved (C)

4. Rapid Troop Movement - Motorcycle Tactics Developed, Training Increased

A, B

5.

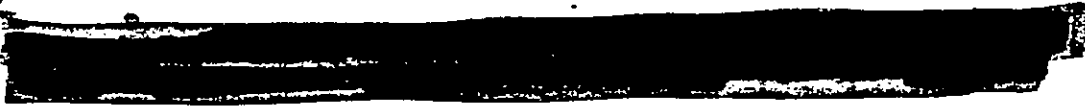

C. Air Operations, General:

1. Overview
2. Command & Control - E-3A (AWACS) Expands Force Management Capability
3. Airfield Seizure - Airfield Assault, Seize, and Hold Capability Developed (S)
4. Combat Control Team Operations Improved
5. Landing Zone Acquisition & Lighting - Optimum Lighting Equipment/Configuration Established
6. Landings on Unprepared Surfaces - Off Runway Capability Significantly Expanded (S)
7. Short Takeoff & Landing - XC-130 Development Provides Potential for Very Short Field C-130 Operations (S)
8. Maintenance Support to Assure Airframe Reliability Requires Increased Emphasis

D. Air Operations, Helicopter:

Joint Helicopter Operations Developed

1. USA/USAF Joint Operating Procedures
2. Enroute Formation Procedures
3. Terminal Operations
4. Communications
5. Forward Area Refueling/Rearming Points (FARRP)

H-53 Operations Procedures Developed

6. H-53 Tactical Capability
7. Pathfinder Capability
8. Dust Out Landing Problems (S)

Modifications Accomplished/Required

9. CH-47 (PLUS)

10. AH-1

11. [REDACTED]

12. [REDACTED]

13. OH-58C (ELN)

14. UH-60

15. H-53

16. OMEGA

A

E. Air Operations, Fixed Wing:

MC-130 Operations:

1. Rapid Offload of Assault Troops & Vehicles Developed (C)

2. Procedures for Rigging and Dropping Motorcycles with Troops Developed (C)

3. Major Modification to MC-130s Accomplished

AC-130 Operations:

4. Low Level Tactics Expanded

5. Variant Firing Techniques Developed

6. Fire Control Systems Evaluated

7. Firing With External Tanks Tested (C)

8. Munitions Requirements Expanded

9. Major Modifications to AC-130s Accomplished

HC-130 Operations:

10. Helicopter Aerial Refueling Procedures Refined

11. Tanker & Receiver Coordination Procedures at Forward Operating Location Reviewed

12. Exercise/Contingency Planning Problems Examined

13. Navigator Manning Policy Recommendations Formed

14. Major Modifications to HC-130s Accomplished

F. Air Defense:

- 1. Stinger Missile Improvements Accomplished
- 2. Vulcan Cannon Night Sight Developed (C)
- 3. Command, Control & Communications Tailored to Special Operations Requirements

G. Command, Control & Communications:

Command and Control:

- 1. Command Structure and Doctrine Developed, Tested
- 2. Forward Command Post C&C Package Established
- 3. E-3A Airborne Command Post Concept Designed, Tested
- 4. CEOI Methods and Procedures Developed, Employed
- 5. Special JTF Time Keeping Concept Developed

Communications Doctrine:

- 6. Secure Long-Haul Communications Policy Developed
- 7. Operational COMSEC Policy Examined
- 8. Senior Communications Operators Cadre Established, Trained
- 9. ZEBRA Communications Concept Developed to Improve Command and Control Reliability

Fixed Base Communications:

- 10. Compartmented Garrison Communications Nets Established
- 11. [REDACTED]
- 12. Base Stations Established at Component Headquarters for Unit Training
- 13. KY-70 Secure Voice Devices Obtained, Employed

Operational Communications:

- 14. Long Range Communications System Developed



- 15. Back-up Long Range Communications System Developed
- 16. SATCOM Procedures for Special Operations Devised, Tested

Special Communications Devices:

- 17. Unattended Weather Reporting Station Conceived, Outlined (C)
- 18. Monitor Loudspeakers Acquired, Used
- 19. Highly Portable Wireline Secure Voice Capability Developed (C)

Special Communications Techniques:

- 20. Procedures, Methods for Communication with Clandestine Elements in Hostile Territory Established (C)
- 21. Multiple Means of Reception of In-Country Transmissions Employed (C)
- 22. Scintillation Problems Examined, Solutions Developed (C)
- 23. SATCOM Jamming Problems Recognized, Solutions Developed (C)
- 24. COMSEC Equipment Signature Problems Examined, Fixes Devised and Implemented (C)
- 25. Unique Cryptographic Key Lists Obtained, Employed

Communications Administration:

- 26. Satellite Access Problems Examined, Procedures Devised (C)
- 27. Procedures Established for Obtaining Training Frequencies
- 28. COMSEC Monitoring Conducted
- 29. MX-360 Radio Standardization Evaluated, Procedures Established
- 30. CINCPAC/CINCEUR Crypto Material Compatibility Problems Resolved (C)

Communications Logistics:

- 31. Force Activity Designation I Established for Communications Equipment (C)
- 32. Manpack SATCOM Terminals Obtained, Employed (C)
- 33. Manpack SATCOM Antennas Developed, Tested, Procured (C)
- 34. UHF SATCOM Terminals Obtained, Utilized

- 35. Aircraft Compatible Power Sources for WSC-3 SATCOM Terminals Acquired (C)
- 36. SATCOM Radio Frequency Preamplifiers Procured, Installed
- 37. Aircraft Mounted SATCOM Antennas Located, Tested, Acquired (C)
- 38. E-3A Radios Modified for Special Operations
- 39. Communications Equipment Package Developed for JTCF
- 40. Replacement for PARKHILL COMSEC Equipment Examined (C)

H. Logistics:

- 1. Introduction
- 2. Force Equipped Under OPSEC Conditions
- 3. MAC Airlift Extensively Utilized
- 4. Aerial Delivery of Heavy Supplies & Equipment Enhanced
- 5. Night Fighting Capability Enhanced (C)
- 6. Logistic Support Provided to Deployed JTF Components
- 7. Medical Support Expanded

I. SECURITY:

- 1. General
- 2. Program Access Controlled and Monitored
- 3. Classification Guide Developed
- 4. Project Information Compartmented
- 5. Conference Security Improved
- 6. Dedicated, Secure Communications Established
- 7. HF Radio Frequencies Carefully Selected
- 8. Callsign Procedures Improved
- 9. Codeword Procedures Improved
- 10. Telephone Security Procedures Improved

11. PARKHILL Traffic Analysis Reveals Problem Areas (C)
12. PARKHILL Signature Problems Identified (C)
13. Other Communications Problems Identified
14. Methods Developed for Handling Media Inquiries

J. INTELLIGENCE:

Extensive Intelligence Report Compiled and Distributed Separately.

J-38

TO: SECRET	CLASSIFICATION	FOR USE BY ORIGINATING DIRECTORATE	
DJS	SECRET	DJSM NO.	ODJS SUSPENSE DATE
THRU:		DJSM DATE	
SUBJECT: Review of Special Operations Techniques and Capabilities (U)	ACTION		
	APPROVAL	SIGNATURE	INFORMATION
	X	X	

REMARKS

1. ~~1.0/81~~ DJS tasked* the J-3 to provide a review and analysis of the Joint Task Force Capability Review, a report prepared by MG James B. Vaught, USA. In reply to that tasking, J-3 proposed** that copies of the document, "sanitized" to disassociate it from any specific actions associated with the rescue attempt in Iran, be distributed to the Services, certain unified and specified commands, the RDJTF and ~~to be further distributed to selected components.~~

2. (U) The attached document has been sanitized and memorandums of promulgation have been prepared.

3. (U) Recommend release of the sanitized document and signing of the proposed memorandums.

References:

- * DJSM 901-81, 15 May 1981
- ** J3M 2188-81, 7 July 1981

~~DECLASSIFIED TO SECRET WHEN
SEPARATED FROM ATTACHED
CLASSIFIED BY: Director, J-3
REVIEW ON: 2 October 2001
EXTENDED BY: Director, J-3
REASON: 2.301(a), 5.6.6~~

*Classified by DDO NMCC 4 Aug 92
Declassify on OADR
Downgrade to Secret
DDO NMCC 4 Aug 92*

ACTION OFFICER LTCOL, USAF J-3, SOD/bm EXT 55805	COORDINATION/APPROVAL					
	OFFICE	NAME & DATE	EXTENSION	OFFICE	NAME & DATE	EXTENSION
	J-31	<i>[Signature]</i>	570243			
	EXEC	<i>[Signature]</i>	78863			
	J-33	<i>[Signature]</i>	72608			
MILSEC	<i>[Signature]</i>	51532				
DATE OF PREPARATION 2 Oct 81	CLASSIFICATION SECRET		SOD	<i>[Signature]</i>	55814	

~~SECRET~~

~~SECRET~~

Maybe
what
see to?

THE INFORMATION ON THE STATUS OF RECOMMENDATIONS APPLICABLE TO THEM AND RESPOND IN ONE OF THE FOUR CATEGORIES LISTED HERE. (?)

MOST OF THE RECOMMENDATIONS IN THE REPORT WERE DIRECTED TOWARD THE ARMY AND AIR FORCE AND, AS A RESULT, THOSE TWO SERVICES PROVIDED THE MAJORITY OF THE RESPONSE DATA.

A SUMMARY OF THE ARMY RESPONSES IS AS SHOWN.

A SUMMARY OF THE AIR FORCE RESPONSES FOLLOWS.

THE NAVY, MARINE CORPS AND MISCELLANEOUS SERVICES ARE DISCUSSED HERE.

THE CAPABILITY REVIEW PROVIDES A COMPENDIUM OF THE PROBLEMS *and the recommendations it contains*

ENCOUNTERED BY THE JTF WITH COMPLETED OR PROPOSED SOLUTIONS. AS *will be an extremely* SUCH, IT ~~IS~~ VALUABLE DOCUMENT FOR FUTURE PLANNERS OF SIMILAR OPERATIONS

WHEN THE PRESENT CADRE *and* OR CORPORATE MEMORY OF THOSE PERSONNEL WHO PARTICIPATED IN THE JTF HAS BEEN DISSOLVED. *It is therefore* ~~THEREFORE IT~~

~~IS~~ RECOMMENDED THAT COPIES OF THE CAPABILITY REVIEW BE PROVIDED TO THOSE ORGANIZATIONS WHICH HAVE THE HIGHEST PROBABILITY OF BEING CALLED UPON SHOULD A SIMILAR SITUATION ARISE IN THE FUTURE.

THOSE ORGANIZATIONS ARE LISTED HERE.

Because of the sensitivity of many of the items contained in the capability review

IT IS NOT RECOMMENDED ~~TO REQUEST~~ OTHER AGENCIES ~~TO~~ REVIEW THE *that*

DOCUMENT. HOWEVER, AS SHOWN, THE SPECIAL OPERATIONS ADVISORY PANEL *access to* SHOULD HAVE THE DOCUMENT ~~AT THEIR DISPOSAL~~ TO READ AND PROVIDE COMMENTS IF THEY SO DESIRE.

~~SECRET~~

~~SECRET~~ GOOD MORNING GENTLEMEN. THIS IS AN INFORMATIONAL BRIEFING ON THE STATUS OF RECOMMENDATIONS OUTLINED IN THE JTF CAPABILITY REVIEW.

THE REVIEW WAS PREPARED AT THE DIRECTION OF MGEN VAUGHT TO ~~PROVIDE,~~
~~IN HIS WORDS, "HOW WE HAVE DONE WHAT WE HAVE DONE, AS WELL AS"~~

DISCUSS ~~THE~~ THE PROBLEMS AND UNFINISHED TASKS* REGARDING CAPABILITIES, EQUIPMENT, TECHNIQUES AND PROCEDURES DEVELOPED IN RESPONSE TO HIS TASKING AS ~~JTF~~ COMMANDER OF THE FORCE ~~TASKED TO RESCUE~~ US CITIZENS

HELD HOSTAGE IN IRAN. IN ADDITION, ~~RECOMMENDATIONS AS TO DISTRIBUTION OF~~ AND ~~FURTHER REVIEW OF THE REPORT ARE PROVIDED.~~ *Joint task given the mission of rescuing the briefing will also provide access to the review and the recommendations for it collection.*

THE JTF CAPABILITY REVIEW CONSIST OF SOME 114 SEPARATE PRINCIPLE ITEMS, ~~SOME PRINCIPLE ITEMS HAD NO OR ONLY ONE~~ ACTION RECOMMENDATIONS *with various numbers of sub-items and related to each principle items.*

~~WHILE OTHERS HAD NUMEROUS SUB ITEMS.~~ FOR EXAMPLE, THE MAJOR ITEM UH-60 ~~HAD~~ 8 SUB-ITEMS AND RECOMMENDATIONS. ~~A TOTAL OF 265~~ *encompassed in excess of 250*

~~SUB ITEMS~~ REQUIREMENTS OR RECOMMENDATIONS WERE NOTED, SOME OF WHICH WERE ~~COMPLETED~~ *eventually* AS PART OF THE JTF OPERATION. OTHERS REMAINED OPEN AT THE TIME OF WRITING AND ARE TO BE ADDRESSED HERE TODAY.

each has been FOR CONVENIENCE, SUB-ITEMS WERE PLACED INTO 1 OF 6 SUB-CATEGORIES UNDER ONE OF THREE MAJOR CATEGORIES (PERSONNEL, MATERIEL, PROCEDURES).

THE NUMBER OF ITEMS PLACED IN EACH SUBCATEGORY ARE AS SHOWN. ~~THE~~ *THESE FIGURES INCLUDE* SERVICES, ~~AND THE~~ ~~SECRET~~ ~~SECRET~~ AND DIA WERE REQUESTED TO

A

Classified by JAS on 11/1/88



J-46

13M-2005'81
08 JUN 1981

THE JOINT STAFF

MEMORANDUM FOR DIRECTOR, DEFENSE INTELLIGENCE AGENCY

Subject: JTF Capability Review (U)

1. (U) As an aftermath of the Iranian rescue attempt, a report, JTF Capability Review (at attachment), was produced which outlines many of the procedures, techniques, and pieces of equipment, that were developed in response to the situation. Many of the problems identified were expeditiously handled at the time, but many of the actions are of a long term or continuing nature. Three of the items identified in the report (marked as TABS A, B, and C) relate to actions required of DIA.
2. (U) The Director, Joint Staff has tasked the Director, J-3 to identify the status of all recommendations and proposals in the report. Specifically, there is interest in identifying those items that have been implemented, those which are to be implemented with an estimated completion date, those requiring further study and analysis, and those which will not be implemented.
3. (U) Request your comments on those three items identified as DIA items. Request those comments be provided to the Special Operations Division, J-3 by 22 June 1981 to allow its inclusion in a briefing to be presented to Service OPSDEPS on 1 July 1981.

James H. Jones
 Major General, USA
 Vice Director for Operations

Attachment
a/s

Copy to:
Director, Joint Staff

CLASSIFIED BY: Director, J-3
 DATE FOR) DECLASSIFICATION
 OR (X) REVIEW
 IS: 5 June 2001
 EXTENDED BY: Director, J-3
 REASON: 5200.1R, Para 2-301c5&6

When Enclosure is Detached
this document is downgraded
to SECRET

~~SECRET - SENSITIVE~~

~~SECRET~~

ORIGINATOR <u>DIB</u>	DATED <u>11 Jun 41</u>	CLASSIFICATION <u>SECRET</u>	CONTROL NUMBER <u>DIB 103-51</u>
DATE RECEIVED IN DIA	SUSPENSE DATE	REGISTERED NUMBER	FILE DESIGNATION

DESCRIPTION OF MATERIAL
JTI Information Review Memo

J-47

CLASSIFICATION REVIEW EO 12356
 CONDUCTED ON 4 Aug 92
 DERIVATIVE CL BY DDO nmc c
 DECL DOWNGR TO _____
 REVM ON OADR
 DERIVED FROM Multiple Sources

OFFICE	COPY	DATE/TIME	SIGNATURE	OFFICE	COPY	DATE/TIME	SIGNATURE
<u>[Redacted]</u>				4			
<u>2000</u>	<u>2</u>	<u>26 JUN</u>	<u>[Signature]</u>	5			
<u>[Redacted]</u>				6			

DESTRUCTION CERTIFICATE (Check appropriate box)

THE MATERIAL LISTED HEREON HAS BEEN DESTROYED TORN AND PLACED IN BAG NO. _____ AND COMMITTED TO THE AUTHORIZED DESTRUCTION FACILITY (DIAR 50-2)

SIGNATURE CERTIFYING OFFICIAL	OFFICE SYMBOL	SIGNATURE WITNESSING OFFICIAL	OFFICE SYMBOL
	DATE		DATE

~~SECRET~~



~~SECRET~~

~~SECRET~~
THE JOINT CHIEFS OF STAFF
WASHINGTON, D.C. 20301

J-49
4

29 May 1981

THE JOINT STAFF

MEMORANDUM FOR: Deputy Chief of Staff for Operations and Plans, Department of the Army
Deputy Chief of Naval Operations (Plans, Policies and Operations), Department of the Navy
Deputy Chief of Staff for Operations, Plans and Readiness, Department of the Air Force
Deputy Chief of Staff for Plans, Policies and Operations, United States Marine Corps

Subject: Review and Analysis of the Joint Task Force Capability Review (11 May 1981 Report by MG James B. Vaught, USA) (U)

1. (c) On 15 May 1981, the Director, Joint Staff requested the J-3 provide subject review and analysis with a final report to the Operations Deputies, in the form of a briefing. The review and subsequent report should:

- Identify status of the recommendations and proposals in MG Vaught's paper. Specifically, identify those items which have been implemented and those which are to be implemented with their estimated completion date. Items requiring further study and analysis as well as those which will not be implemented should also be so identified.

In addition, request your views regarding:

- What the distribution on the report should be.
- What other individuals or groups should review the document. Specifically, should SOAP (or selected members) provide a separate review? Should component elements provide independent review?

A

~~When Enclosure is Detached
This document is downgraded
to Confidential~~

~~CLASSIFIED BY: Director, J-3
DATE FOR () DECLASSIFICATION
OR (XX) REVIEW
IS: 15 Feb 2001
EXTENDED BY: Director, J-3
REASON: 5200.1R 2-301c 5&6~~

~~SECRET~~
~~SECRET~~

- What other recommendations relative to special operations and counterterrorist capabilities, procedures and techniques should be presented to the Operations Deputies?

2. (U) Request your assistance in answering the above questions. Request your comments be provided directly to J-3 Special Operations Division NLT 22 June 1981 to facilitate the development of a 1 July briefing. In addition, request you be prepared to provide representation to a 24 June conference to further discuss items in the Capability Review as well as other recommendations with regard to special operation/counterterrorist capabilities, techniques and procedures.

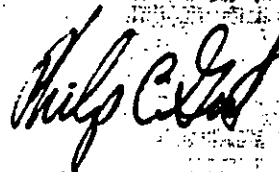

PHILIP C. GAST
Lieutenant General, USAF
Director for Operations

Attachments

2 copies, Joint Task Force
Capability Review (TS)

~~SECRET~~

ODJS SUMMARY SHEET

JUN 81

TO: [REDACTED]	CLASSIFICATION SECRET	FOR USE BY ORIGINATING DIRECTORATE	
THRU: [REDACTED]	DJSM NO.	ODJS SUSPENSE DATE	
SUBJECT: J-3 Capability Review	ACTION		
	APPROVAL	SIGNATURE	INFORMATION
			X

REMARKS:

1. (U) In accordance with J-3 memorandums*, the Services, DIA and [REDACTED] have provided** comments on subject document. A synopsis of comments regarding three specific questions posed by these memorandums as well as other remarks is provided. The J-3 memorandums were generated in reference to a DJS memorandum requesting*** the same information.

2. (U) As can be seen, only [REDACTED] and DIA provided direct comments on specific items/sub-items. The Services believe the document has not been properly staffed and therefore it is inappropriate for them to commit themselves at this time. All agree it is an excellent reference document, but there was some disagreement on further distribution.

3. (U) Based upon the comments received, it would appear proper to recommend, with Service concurrence, the following actions to DJS.

a. (U) Due to the lack of specificity in the Service responses, there appears to be little that can be briefed to the OPSDEPS at this time (per the original DJS tasking). However, both the Army and Marine Corps OPSDEPS addressed separate issues that they felt should be discussed among or briefed to the collective OPSDEPS.

b. (U) A copy or copies should be provided to the SOAP requesting they provide comments on any areas they believe require their addressal and on the document as a whole.

When Enclosure is Detached this document is downgraded

~~SECRET~~

CLASSIFIED BY: Director, J-3
 DATE FOR () DECLASSIFICATION
 OR (x) REVIEW
 IS: 26 June 87
 EXTENDED BY: Director, J-3
 REASON: 5200.1R, Para 2-301c5&6

*Classified by DDONM/C
 Declassify on: OADR*

ACTION OFFICER
 [REDACTED]
 LTCOL, USAF
 SOD/J-3
 Ext 72231

COORDINATION/APPROVAL					
OFFICE	NAME & DATE	EXTENSION	OFFICE	NAME & DATE	EXTENSION
SOD	[REDACTED]	55814			
J-33					
EXEC					
J-31					

CLASSIFICATION REVIEW E9 12356
 CONDUCTED ON 4 Aug 81
 DERIVATIVE PL BY DDONM/C
 DECL DOWNGR TO Secret
 REW: [REDACTED]
 REASON: Multiple Sources

DATE OF PREPARATION
 26 June 81

CLASSIFICATION
 [REDACTED] ~~SECRET~~

~~SECRET~~

~~SECRET~~
~~SECRET~~

c. (S) Copies of the document (sanitized to disconnect it from any specific actions associated with Iran) should be distributed to the Services and/or unified and specified commands to be further distributed to specific components, i.e.,

A - Special Operations Units (SF, SEAL, AFSOF, as well as UW command and control organizations).

[REDACTED]

- Selected Marine Corps units as determined by HQ USMC.

RDJTF.

A d. (e) Provide a spread sheet, similar to the one attached, to the OPSDEPS and, as each OPSDEP recommended [REDACTED] review the document, provide them a copy of the [REDACTED] reply (with his concurrence).

References:

* J-3 Memorandums (3) of 29 May and 8 June 1981

A ** Replies by (1) Army, (2) Navy, (3) Air Force, (4) Marine Corps,

(5) DIA, and (6) [REDACTED]

*** DJSM 901-81, 15 May 1981, "Review and Analysis of the Joint Task Force Capability Review (11 May 1981 Report by MG James B. Vaught, USA)"

~~SECRET~~

THE JOINT CHIEFS OF STAFF
OFFICE OF THE DIRECTOR FOR OPERATIONS

Date 30 Jan

To

J-33

Subject:

- ① Want to discuss, please
- ② Concur services need to work it: but not sure how visibility will be maintained -- need a system for that -- like a report in 6 months or:
- ③ Also want to consider a conference meeting chaired by J-3 with Sorin, to not start etc. Represented

~~SECRET~~

~~SECRET~~

Address the needs of [redacted]
and what equipment is required
now and longer term - a
program review, if you
will.

(19) As a related matter, let's
ask [redacted] to brief us
on training, exercises
levels of expertise now &
when we need improvements
in capabilities - Item
4 Page #3 - perhaps
mid July
E.H.

~~SECRET~~

USES SUMMARY SHEET

TO: DJS	CLASSIFICATION SECRET	FOR USE BY ORIGINATING DIRECTORATE SECRET			
THRU:		DJSM NO.	ODJS SUSPENSE DATE		
		DJSM DATE			
SUBJECT: JTF Capability Review	ACTION				
	APPROVAL	SIGNATURE	INFORMATION	OTHER	
	X				

REMARKS

1. (U) DJS memorandum requested* J-3 review an analysis of subject review with a report to the Operation Deputies. Accordingly, the Services, DIA, and [redacted] have provided** comments on the document, and a synopsis of those remarks is provided.
2. (U) As can be seen, only [redacted] and DIA provided direct comments on specific items/sub-items. The Services believe the document has not been properly staffed, and therefore it is inappropriate for them to commit themselves at this time. All agree it is an excellent reference document, but there was some disagreement on further distribution.
3. (U) Based upon the comments provided, the following actions are recommended:
 - a. (U) Due to the lack of specificity in the Service responses, the analysis should not be briefed to the OPSDEPS at this time. The following recommendations suggested by the Army and Marine Corps OPSDEPS should be discussed by the combined OPSDEPS and action taken as required.
 - (1) (U) "The Joint Staff action on establishment of congressional committees for oversight of counterterrorism should be completed and considered as a matter of priority by the Operations Deputies." (USA)

CLASSIFIED BY: Director, Joint Staff
 DATE FOR () DECLASSIFICATION
 OR (.x) REVIEW
 IS: 29 June 2001
 EXTENDED BY: Director, Joint Staff
 REASON: 5200.1R, Para 2-301c5&6

When Enclosure is Detached
 this document is downgraded
 to SECRET

ACTION OFFICER [redacted] LTCOL, USAF SOD/J-3 Ext 72231	COORDINATION/APPROVAL					
	OFFICE	NAME & DATE	EXTENSION	OFFICE	NAME & DATE	EXTENSION
	J-3					
DATE OF PREPARATION 29 June 81	CLASSIFICATION SECRET					

(2) ^(U) (S) "Action should be initiated by the Joint Staff concerning the US Government counterterrorism crisis management structure and command and control related issues." (USA)

A

(3) (S) "It has been a full quarter since the last [redacted] report to the CJCS. This briefing period could provide a good opportunity to update the Operation Deputies on the status, readiness, and capabilities of the [redacted] and the major problems yet awaiting resolution." (USMC)

b. (S) Based upon recommendations from the Army and Air Force, the two Services with the majority of the actions to complete in the review, it is recommended that the SOAP review the document.

c. (S) Copies of the document (sanitized to disconnect it from any specific actions associated with Iran) should be distributed to the Services and/or unified and specified commands to be further distributed to specific components, i.e.,

A

- Special Operations Units (SF, SEAL, AFSOE, as well as UW command and control organizations).

- [redacted]

- Selected Marine Corps units as determined by HQ USMC.

- RDJTF.

A

d. (S) Provide the attached spread sheet, to the OPSDEPS and, as each OPSDEP recommended [redacted] review the document, provide them a copy of the [redacted] reply.

References:

(S) * DJSM 901-81, 15 May 1981, "Review and Analysis of the Joint Task Force Capability Review (11 May 1981 Report by MG James B. Vaught, USA)"

A ** Replies by (1) Army, (2) Navy, (3) Air Force, (4) Marine Corps, (5) DIA, and (6) [redacted]

~~SECRET~~

	TRAINING	ORGANIZATION	IMPROVEMENTS	DEVELOPMENT ACQUISITION	DOCTRINE	TECHNIQUE
USA	A-5; A-7; B-1; B-2C; B-2G; B-3C; E; D-5; D-5A; E-2C; E-3; E-1; E-2; E-2; G-2; H-4	D-5; G-10; H-7;	A-4A; E-1; E-1; J-4; D-1C; E-1; E-2; E-2; D-1E; E-1; E-1	A-1; B-1; E-1; G-1C D-1; E-1; E-1; E-1 E-1; E-1; E-1; G-12 G-17; G-17; G-17 H-5	B-1; B-2C; E-3E; E-1; H-4; H-7;	A-3; E-1; E-1; E-1; B-1; E-1; E-1; E-1; D-1; E-1; G-1; H-1 H-5; I-13; I-13
USN			G-40			
USAF	A-1; A-1; A-1; A-1; B-1; B-1; E; D-3; B-2; E-1; E-1; E-1 E-1; G-3;	G-1; E-1; G-1	E-1; E-1; E-1; E-1; E-1; E-1; E-1; E-1; E-1; E-1; E-1; E-1; E-1	A-1; E-1; E-1; E-1; E-1; E-1; E-1; E-1; E-1; E-1; E-1; G-1; G-1; G-1; E-1; E-1; E-1;	G-1; B-1; E; D-1 E-1;	A-1; E-1; E-1; E-1; E-1; E-1; E-1; E-1; G-1; G-1; G-1; H-1; H-1; H-1; I-1 I-1; I-1
USMC			G-40	F-2		G-13; H-1; H-1; I-13; I-13
DIA			B-20, H		E-8A	
	G-4; G-5; G-7; G-8 G-21	G-11		G-12		G-9; G-13; G-21; G-25 H-1; H-1; I-1; I-1 I-1; I-1; I-1; I-1
			I-12			
OJCS			G-11; G-10	G-13	G-1; G-21	G-13

~~SECRET~~

HANDLE VIA COMINT CHANNELS ONLY

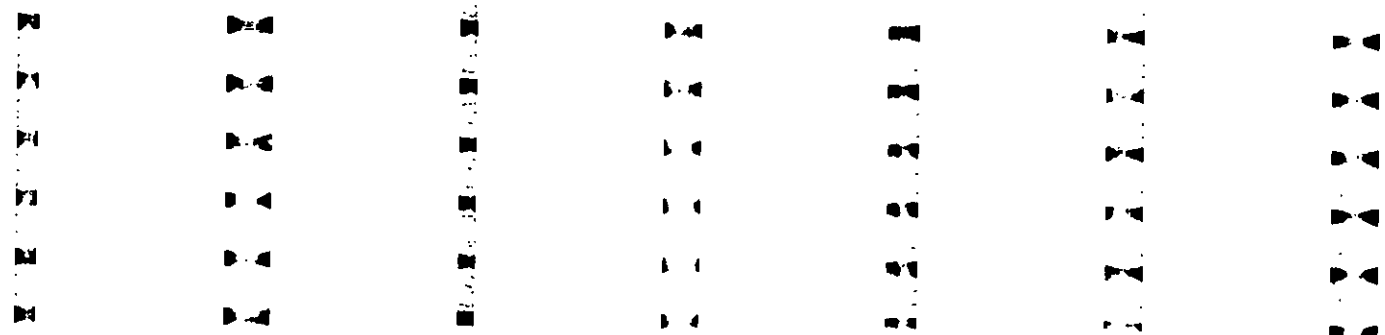

~~SECRET~~
~~SECRET~~

	PERSONNEL		MATERIEL		PROCEDURES	
	TRAINING	ORGANIZATION	IMPROVEMENTS	DEVELOPMENT/ ACQUISITION	DOCTRINE	TECHNIQUE
USA	A-5; A-7; E-1; E-20; E-25; G; G-30; E; D-5; D-25; D-20; D-9; E-1; E-2; F-2; G-2; H-4 D-7; G-4	D-5; G-10; H-7;	A-40, B, D; E-1; D-4; D-6; C, E (CH-2); D-8; D-10 D-11; D-14; G-4	A-2; G-1; G-2; G-3; E-3; G-4; I-5; D-7 D-10; D-11; D-14; D-1 F-1; F-2; F-3; G-12 G-34; G-37 H-5; G-31	E-1; E-2; E-5; I-1; H-4; H-7;	A-3; A-15; F; A-2; B-1; E-5; D-2; D-3 D-2; F, G; G-13; H-2 H-6; I-13; I-14
USN			G-40	A-2; G-1; G-20		A-2; G-13; H-1 H-5; I-13; I-14
USAF	A-5; A-6; A-7; E-1; E-2; C-30; E; D-2; D-20; E-1; E-2; E-7 E-10; G-3; D-7	C-4E; E-13; G-10	E-1; C-30; D; C-10; C-2; C-3; D-2; D-3; D-36; B; C; D; E; I-1; D-1; D-2; D-5; E-1 E-7; E-9; E-14; G-3	A-2; A-10; A-10; B-2; B-4; C-1; C-10; D; C-4; E; F; G-1; E-1; E-2; E-4; E-5; E-7; E-9; G-12; G-15 G-20; G-3; G-37 H-5; G-31	G-1; G-2; E; D-1 E-12;	A-2; A-10; A-10; B-2; C-1; D; D-1; D-2; D-3; E-5; E-10; E-12; G-1; G-13; G-37 H-5; H-9; H-11; I-1 I-13; I-14; I-15
USMC			G-40	F-2		G-1; G-13; H-1 I-13; I-14
DIA						
	G-21	G-11	G-4	G-15; G-37		H-7; G-13; G-31; G-37 H-5; H-9; H-11; I-1 I-13; I-14; I-15

10
[Redacted]

~~SECRET~~

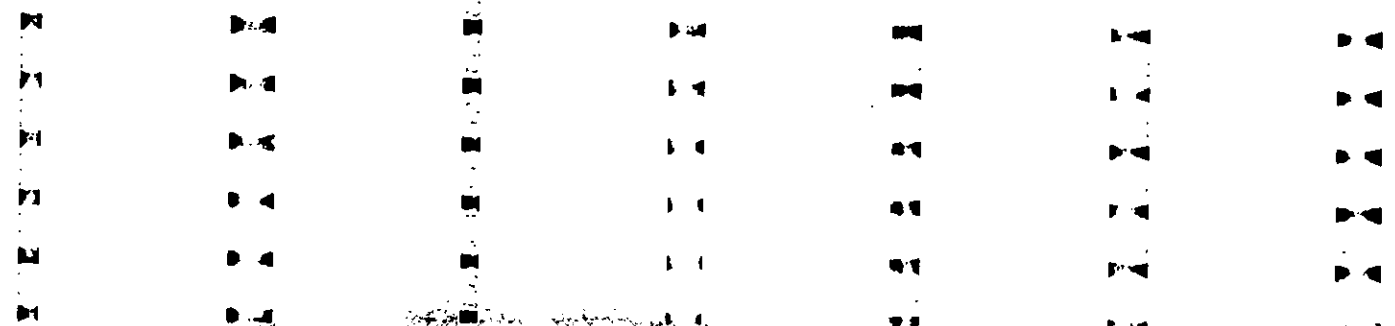

Proposals and Recommendations

for further Review

on Distribution

~~SECRET~~

Remarks

A ARMY None identified. To be provided after ARSTAF conducts more thorough review, currently underway.

Yes by SOAP and [redacted]

[redacted]
o Unified Commanders
o CINCMAC o COMTAC
o CINCSAC

Army OPSDEP made the following two recommendations:

- o The Joint Staff action on establishment of congressional committees for oversight of CT should be completed as a matter of priority by the OPSDEPS.
- o Action should be initiated by the Joint Staff concerning the US Govt. CT crisis management structure and command and control related issues.

A NAVY None identified. Not a joint doc and has wide ranging implications.

Not by SOAP. Unified Cmdrs and [redacted] should review and take appropriate actions through Service/JCS channels.

Unified Cmdrs [redacted] (further distribution/tasking to subordinates at their discretion).

It is premature, at this time, to treat the report as a joint document to be used as a basis for formulating a plan of action and milestones for the Services.

A AF None identified. Unstaffed document. Premature to commit to actions and/or dates.

Unified and Specified Cmdrs SOAP, [redacted] component MAJCOMS. Selected unit level.

Unified and Specified Cmdrs SOAP, [redacted] component MAJCOMS. Selected unit level.

Results of ongoing Air Force study will be compared with results of JTF Review to determine validated and feasible future courses of action.

A MC None identified. Not properly staffed through Services.

Not by SOAP but [redacted] Joint Staff Directorates and/or responsible Services should review.

Joint Staff Directors and/or Services for review and initiation of warranted actions.

Not thoroughly reviewed and concurred in by Services. Document should not be considered for joint action in its present form. Request update by [redacted] on status, readiness and capabilities of [redacted] and major problems remaining.

DIA Written comments on two sub-items Verbal comment on one other.

No comment.

No comment.

Verbal comment on sub-item was that it is not a DIA responsibility to devise/maintain instructions and/or wiring diagrams on how to "hook up" various atomotive equipment but is an operators function.

A [redacted] Comments on 38 specific items.

None required.

C Unnecessary. Present distribution to Services, [redacted] DTA [redacted] enough [redacted]

~~SECRET~~

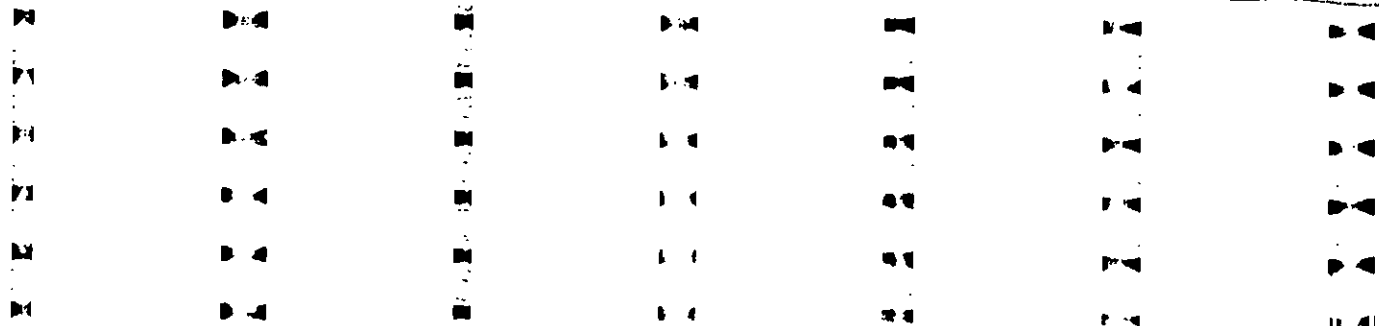

B-3b

PERSONNEL

~~SECRET~~

MATERIEL

PROCEDURE

A

	TRAINING	ORGANIZATION	IMPROVEMENTS	DEVELOPMENTS/ ACQUISITION	DOCTRINE	TECHNIQUES
USM	A-5; A-7; E-1; G-10 B-2F, 9; E-10, 12; D-1; D-2; E-10, 12; E-1; E-2	D-5	A-4 a, b, d; B-1; D-4; D-10, 11; D-12; D-7; D-10; I-1; I-11	A-2; B-1; B-2g B-2d; C-3A; C-4 D-5; D-9; D-10; D-11 D-14; D-1; E-32 G-33	B-1; B-2c, B-2d D-1	A-3; A-4e, F; A-8; B-1, B-2 D-2, D-3; I-1
USN				F-1; G-4		A-8;
██████████	D-6K; I-2; D-7g					
USAF	A-5; A-6, A-7; B-1; E-10, D-11; C-3a; D-1; D-12; E-1 E-2	C-4c	B-1; C-3a, 2; D-11 D-7; D-8; C-1; I-4 D-12, E-1, A, C; D-7 E-1; D-15; E-3	F-1; A-10; A-10; B-2d; I-4; C-2 C-1, C-2; C-4; F; C-7 D-15; I-1; E-2	B-1; C-2b, e; D-1	A-3; A-4e; A-6 E-5; C-3a, b; D-2, D-3, D-4
USMC			SECRET	F-1		
DIA			B-2c, h		B-3a	

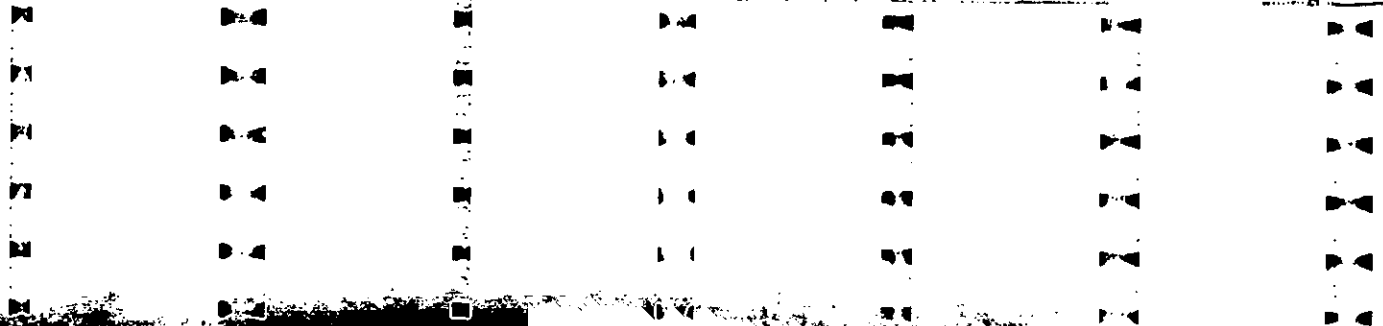

A

J-51

THE JOINT STAFF

21 May 1980

MEMORANDUM FOR THE RECORD

Subject: Cost Associated with Iran Hostage Rescue Attempt

Mr. Al South (OASD/C) has passed on telephonically to LTC Olynyk the following information with respect to the status of the cost package:

- a. The package has been passed from Mr. Hamilton to the OSD Comptroller, and is with Mr. South.
- b. The following changes to the package were agreed upon by Mr. Hamilton and OSD Comptroller and will be introduced into the package, with copies furnished to MG Dyke:

The cost for RH-53D and C-130 aircraft will be deleted, with a footnote added as follows: The cost for these aircraft is excluded on the basis that the decision has not been reached as to when, how, and to what extent this capability will be replaced.

c. The package with a cover letter will be signed today, 21 May, and forwarded to Senator Hollings. MG Dyke will be provided with a copy.

d. The cover letter to Senator Hollings will indicate that this package has been coordinated with Mr. Joy. Mr. South assumed that MG Dyke discussed the package with Mr. Joy only in broad outlines, not in any detail.

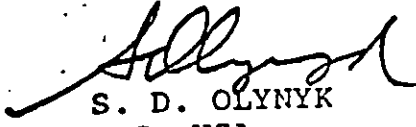
S. D. OLYNYK
LTC, USA

~~CONFIDENTIAL~~

~~SECRET~~

COSTS ASSOCIATED WITH IRAN RESCUE ATTEMPT - US ARMY
(ALL COSTS IN FY-80 DOLLARS)

<u>1. Estimated value of items expended on the mission</u>	<u>Estimated Cost</u>
2020 Minor weapons, clothing, communications and miscellaneous stock funded items	\$1,037,591
2035 Communications equipment and non-standard items	100,294
2033 Research and development items and REDEYE systems	13,656
Subtotal	<u>\$1,151,541</u>
	<u>Actual Cost</u>
<u>2. Training and Preparation</u>	
2020 Base Support	\$ 190,762
<u>3. Airlift and Other Support</u>	
2020 Army airlift and temporary duty	44,627
Total, Army	\$1,386,930

~~CLASSIFIED BY: Dir, DCSOP, OD~~
~~REVIEW ON: 15 May 86~~

~~CONFIDENTIAL~~

~~SECRET~~

~~CONFIDENTIAL~~

~~SECRET~~

COSTS ASSOCIATED WITH IRAN RESCUE ATTEMPT - US AIR FORCE
(ALL COSTS IN FY 80-DOLLARS)

1. Estimated value of items expended a/
on the mission Estimated Cost

3010 Palletized Inertial Navigation Systems (PINS)	\$1,015,000
3080 M-151A2 Jeep destroyed	3,196
3080 Fuel System	130,025
3080 Miscellaneous Equipment	158,098
Subtotal	\$1,306,319

~~2.~~ Training and Preparation Actual Cost

[KC-135 Tanker support during training,
deployment and employment]

3010 Depot Spares	\$ 85,873
3400 Aviation POL, Depot Equipment Maintenance (DPEM), Supplies	3,341,438

C-130 support provided above normal training
requirements

3010 Depot Spares	10,430
3400 Aviation POL, Depot Equipment Maintenance (DPEM), Supplies	96,847

Subtotal

\$3,534,588

a/ Excludes costs of the C-130 aircraft destroyed during the mission since no decision has been made concerning whether replacement will be programmed, and if so, when.

CLASSIFIED BY: HQ TAC/DO Msg
132300Z May 80
DECLASSIFY ON: May 13, 1988

~~SECRET~~

J-56

1 May 1980

FM: [REDACTED]
TO: LTGEN GAST

Subject: Presidential Visit w/JTF Personnel (S)

- 1. (U) The President has indicated a desire to meet with representatives of the various JTF forces that participated in the Rescue Mission. He has already met with some of the forces and the remaining representatives have been alerted.* The following consists of possible options for the desired meeting:
 - a. Option 1. Required JTF personnel would be transported by helo to Camp David and meet with the President at that location. HMX-1 from Quantico (tasked with Presidential support) would provide the required transportation to Camp David.
 - b. Option 2. Required JTF personnel would be gathered at the Pentagon and the President would visit and conduct the desired meeting (ODCR is a possible site).
 - c. Required JTF personnel would be transported by bus to the old Executive Office Building. The Presidential meeting would be conducted in this complex.
- 2. (U) Recommend Option 1 be recommended to the president for the conduct of the desired meeting.
- 3. (U) The attached message enumerated 32 representatives from MAC, PACOM, REDCOM and SAC. In addition, recommend 10 JTF staff personnel** attend for a total of 42 people.
- 4. (U) For compartmentation purposes, the personnel could be divided into two groups, the JTF staff and AC/MC/EC-130 personnel (22 total) and the remainder (20 total). However, compartmentation is not considered a requirement.

Very respectfully,

G [REDACTED]
CDR USN

[REDACTED] SECRET

[REDACTED] SECRET

Declassified by
DDO/VNCC
4 Dec 92

MAJOR GENERAL JAMES B. VAUGHT, USA

E, G
(*) Born 3 November 1926 in Conway, South Carolina. Educated at Georgia State College (BBA) and George Washington University (MS). Veteran of World War II, Korea, and Vietnam. Married, wife [REDACTED] Commander, Joint Task Force.
Location: [REDACTED]

COLONEL [REDACTED], USA

E, G
(*) [REDACTED] Educated at [REDACTED] Vietnam Veteran. Married, wife [REDACTED] Chief of Staff, Joint Task Force.
Location: [REDACTED]

COLONEL JAMES H. KYLE, USAF

G
Born 19 December 1932 in Kansas City, Kansas. Educated at Kansas State University (BS). Vietnam Veteran, 26 years service. Married, [REDACTED] Key mission planner and on-scene commander, Desert Track One. Location: Desert Track.

COLONEL [REDACTED], USAF

G
[REDACTED] Vietnam Veteran, 26 years service. Married, [REDACTED] Chief mission communications planner and director of communications during operation. Location: Pentagon.

LIEUTENANT COLONEL [REDACTED], USAF

G
[REDACTED] Vietnam Veteran, 23 years service. Married, [REDACTED] Primary intelligence planner, JTF J-2. Location: Pentagon.

LIEUTENANT COLONEL [REDACTED], USAF

G
[REDACTED] Vietnam veteran, 18 years service. Married, [REDACTED] JTF J-3 air operations planner. Location: Pentagon.

MAJOR [REDACTED], USMC

G
[REDACTED] Vietnam veteran, 17 years service. Married, [REDACTED] Intelligence planner and tactical intell officer for helicopter unit. Location: NIMITZ.

~~CONFIDENTIAL~~

CHIEF YOEMAN [REDACTED] USN

G [REDACTED] Vietnam veteran, 11 years service. Married,
[REDACTED] Key mission administrative assistant
to Commander, Joint Task Force throughout the operation.
Location: [REDACTED]

LTC Gast - provided

G LTC [REDACTED] - Quinn will get

~~CONFIDENTIAL~~

a

NAME: [REDACTED] NICKNAME: _____
 BORN: [REDACTED] PLACE: [REDACTED]
 RANK: LTC SERVICE: Army DOR: 16 Dec 1970 SSN: [REDACTED]
 DATE OF COMMISSION: [REDACTED] SOURCE OF COMMISSION: (CIRCLE ONE)
 USMA USNA USAFA ROTC (OCS)
 NROTC OTHER: _____

J-3 ASSIGNMENT INFORMATION

DATE ASSIGNED: [REDACTED] ROTATION DATE: 1980
 DIVISION: J3 /DUTY PHONE 55805
 TITLE: Special Plans Branch

AFSC/MOS/DESIGNATOR: _____
 WIFE NAME: [REDACTED]
 NICKNAME: [REDACTED]

CHILDREN NAMES AND AGE:
 [REDACTED] [REDACTED]
 [REDACTED] [REDACTED]

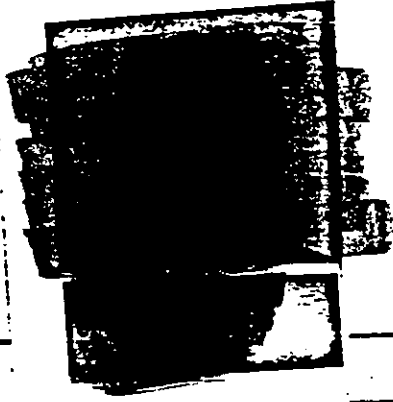

G

CIVILIAN EDUCATION

FROM	TO	NAME OF COLLEGE AND PLACE	STUDY	DEGREE
[REDACTED]	[REDACTED]	[REDACTED]	[REDACTED]	[REDACTED]

MILITARY EDUCATION

FROM	TO	NAME OF SCHOOL AND PLACE	GRADUATE
[REDACTED]	[REDACTED]	<u>Army War College Corresponding Studies</u> <u>CGESC</u>	<u>YES</u>

CAREER HIGHLIGHTS (LAST 4 ASSIGNMENTS)

FROM	TO	POSITION	ORGANIZATION AND STATION
[REDACTED]	[REDACTED]	<u>IG</u>	<u>Bad Hon Div, Ft. Bragg, N.C.</u>
[REDACTED]	[REDACTED]	<u>Dep Comd IG</u>	<u>19th Avn Corps, Ft. Bragg, N.C.</u>
[REDACTED]	[REDACTED]	<u>Br Liaison</u>	<u>2d SF BN, 1st SFG (A&A) OKINAWA</u>
[REDACTED]	[REDACTED]	<u>Chief, Advanced Studies</u>	<u>ISSO CDC, Ft. Bragg, N.C.</u>

AWARDS AND DECORATIONS: SS, LR, BS, MSM(2oc), AM(wv) BS

PUBLICATIONS: _____

LOCAL ADDRESS: [REDACTED]

HOME PHONE: [REDACTED]

UNCLASSIFIED

RESUME OF SERVICE CAREER

As of 18 March 1980

of

C JAMES BENJAMIN VAUGHT, Major General, [REDACTED]

DATE AND PLACE OF BIRTH: 3 November 1926, Conway, South Carolina

YEARS OF ACTIVE COMMISSIONED SERVICE: Over 32

PRESENT ASSIGNMENT: Director, Operations and Readiness, Deputy Chief of Staff for Operations and Plans, United States Army, Washington, D. C. 20310, since August 1979.

MILITARY SCHOOLS ATTENDED

- The Infantry School, Advanced Course
- United States Army Command and General Staff College
- Armed Forces Staff College
- The National War College

EDUCATIONAL DEGREES

- Georgia State College of Business Administration - BBA Degree - Management
- George Washington University - MS Degree - Government Administration

<u>MAJOR PERMANENT DUTY ASSIGNMENTS (Last 10 years)</u>	<u>From</u>	<u>To</u>
Staff Assistant, Western Hemisphere Region, Office, Assistant Secretary of Defense (International Security Affairs), Washington, D. C.	Mar 69	Aug 70
Liaison Officer, United States Army Combat Developments Command, Fort Belvoir, Virginia, with station Vietnam	Aug 70	Mar 71
Senior Advisor, Army Republic of Vietnam Airborne Division, United States Military Assistance Command, Vietnam	Mar 71	Sep 71
Deputy Commanding Officer, 12th Support Brigade, Fort Bragg, North Carolina	Oct 71	Jan 72
Commanding Officer, 1st Corps Support Command (redesignated from 12th Support Brigade in June 1972), Fort Bragg, North Carolina	Jan 72	Jun 73
Chief of Staff, XVIII Airborne Corps, Fort Bragg, North Carolina	Jun 73	Sep 74
Assistant Division Commander, 82d Airborne Division, Fort Bragg, North Carolina	Oct 74	Aug 75
Chief of Staff, Allied Land Forces Southeastern Europe	Aug 75	Sep 77
Commanding General, 24th Infantry Division and Fort Stewart, Fort Stewart, Georgia	Sep 77	Aug 79

UNCLASSIFIED

CLASSIFIED

JAMES BENJAMIN VAUGHT, Major General, [REDACTED] G

<u>PROMOTIONS</u>	<u>DATES OF APPOINTMENT</u>		<u>Other (ORC)</u>
	<u>Temporary</u>	<u>Permanent</u>	
2LT	21 Feb 46	30 Oct 49	
1LT	14 Oct 47	23 Mar 51	6 Nov 47
CPT	4 Sep 52	29 Oct 54	
MAJ	18 Nov 60	26 Jan 62	
LTC	29 Jun 64	2 Jan 69	
COL	26 Jun 69	12 Mar 73	
BG	1 Jul 73	7 Aug 75	
MG	1 Sep 75	28 Jan 77	

US DECORATIONS/BADGES

- Silver Star (with Oak Leaf Cluster)
- Legion of Merit (with 2 Oak Leaf Clusters)
- Distinguished Flying Cross
- Soldier's Medal
- Bronze Star Medal (with Oak Leaf Cluster)
- Meritorious Service Medal
- Air Medals
- Joint Service Commendation Medal
- Army Commendation (with Oak Leaf Cluster)
- Purple Heart
- Combat Infantryman Badge (2d Award)
- Master Parachutist Badge
- Glider Badge
- Office of the Secretary of Defense Identification Badge
- Joint Chiefs of Staff Identification Badge
- General Staff Identification Badge

SOURCE OF COMMISSION: OCS

UNCLASSIFIED

(U) B. MISSION: JTF RICE BOLL CONDUCTS OPERATIONS TO RESCUE US PERSONNEL HELD HOSTAGE IN THE AMERICAN EMBASSY COMPOUND, TEHRAN, IRAN.

(S) (U) B. EXECUTION:

(U) A. CONCEPT OF OPERATION. JTF RICE BOLL CONDUCTS CLANDESTINE AIR INFILTRATION TO VICINITY TEHRAN, IRAN. CONDUCTS GROUND ASSAULT OF AMEMB COMPOUND TO RESCUE HOSTAGES. CONDUCTS AIR ASSAULT TO SEIZE MANZARIYEH AIRFIELD COINCIDENT WITH HELICOPTER EXFILTRATION OF HOSTAGES AND AMEMBASSY ASSAULT FORCE TO MANZARIYEH. AND CONDUCTS FIXED WING EXFILTRATION OF JTF FORCES FROM IRAN TO RECOVERY BASE. THIS OPERATION WILL BE CONDUCTED IN PHASES.

(S) (U) PHASE I.

[REDACTED]

JTF GROUND AND AIR COMPONENTS MARSHAL AT INTERMEDIATE STAGING BASES.

(S) (U) PHASE II. SFOD-D INFILTRATES IRAN DEC

79 BY RH-53-D FROM USS KITTY HAWK TO HELO REFUEL SITE VICINITY SPARSE LAKE. MC-130 DET INFILTRATES IRAN FROM

[REDACTED] CONDUCTS PARADROP OF HELO FARE/FARP SYSTEM VICINITY SPARSE LAKE. HELGS REFUEL. MC-130'S RETURN

TO [REDACTED] (S) (U) PHASE III. HELG DET INSERTS SFOD-D VICINITY

SALT LAKE DEC 79. SFOD-D LINKS UP WITH [REDACTED]

A

A

E

A,C

CLASSIFICATION REVIEW ED 12355

CONDUCTED ON 4 Aug 92
DERIVATIVE CL BY DDO NMCC
DECL. BY DOWNGR TO Secret
REVISED BY OADR
Mullikin, Smead

Classified By: DDONMCC
Declassified ON: OADR

Downgraded to Secret

~~CONFIDENTIAL~~

~~TOP SECRET~~

C
CONDUCTS INFILTRATION OF TEHRAN BY TPLON. HELO DET LAAGERO
AT HIDE SITE VICINITY [REDACTED]
(U) PHASE IV. DEC 29. SPECIAL ASSAULTS ANEMB
COMPOUND, FREE HOSTAGES, HELO DET CREWS SALT LAKE, AND ON
ORDER ASSAULTS INTO ANEMB COMPOUND LEAD TO EXTRACT HOSTAGES
AND SFOD-D. MC-130 DET WITH RANGER FORCE EMBARKED INFILTRATES
IRAN FROM [REDACTED] CONDUCTS AIR ASSAULT INTO MANZARIYEH
AIRFIELD, SECURES AIRFIELD.

E
(U) PHASE V. DEC 29 HOSTAGES, SFOD-D EMBASSY
ASSAULT FORCE AND HELO DET CREWS ABANDON HELICOPTERS UPON
ARRIVAL MANZARIYEH, TRANSFER TO TWO MC-130'S AND EXFILTRATE
IRAN TO RECOVERY BASE. RANGER FORCE DESTROYS
HELICOPTERS AND LOADS TWO MC-130 AIRCRAFT AND EXFILTRATES
IRAN TO RECOVERY BASE.

B. (U) TASKS AND RESPONSIBILITIES:

(1) (U) SFOD-D:

(A) (U) CDR, SFOD-D ASSIGNED DUTIES AS GROUND RECOVERY
FORCE COMMANDER, EFF IMMEDIATELY.

(B) (U) ON ORDER, CONDUCT INFILTRATION OF TEHRAN, IRAN,
FREE US HOSTAGES, EXFILTRATE IRAN TO RECOVERY BASE

A
(2) (U) [REDACTED] RANGERS [REDACTED]:

(A) (U) CDR, [REDACTED] RANGERS ASSIGNED DUTIES AS GROUND
SECURITY FORCE COMMANDER, EFF IMMEDIATELY.

(B) (U) ON ORDER, SEIZE AND SECURE EXFILTRATION AIRFIELD
VICINITY MANZARIYEH, IRAN. TRANSFER HOSTAGES, GROUND

~~CONFIDENTIAL~~ ~~TOP SECRET~~

RECOVERY FORCE AND HELO DET CREWS FROM HELOS TO MC-130'S.
DESTROY HELOS. EXFILTRATE IRAN TO RECOVERY BASE
(U) (C) (TS) BE PREPARED TO ATTACH ONE RANGER SQUAD TO CDR.
RH-53 DET FOR REFUEL SITE SECURITY, ON ORDER.

- (U) (TS) MC-130 DET: SEE ANNEX B (AIR OPERATIONS).
- (U) (TS) AC-130 DET: SEE ANNEX B (AIR OPERATIONS).
- (U) (TS) RH-53 DET: SEE ANNEX B (AIR OPERATIONS).
- (U) (TS) USCINCEUR, USCINCRED, USCINCPAC, USCINCSAC,
USCINCMAC PROVIDE SUPPORT, AS REQUIRED. SEE ANNEXES B
THROUGH G.

C. (U) COORDINATING INSTRUCTIONS:

- (U) (TS) THIS OPLAN IS EFFECTIVE FOR PLANNING UPON RECEIPT;
FOR EXECUTION, ON ORDER COMJTF RICE BOWL.
- (U) (TS) D-DAY, H-HOUR IS 0100 LOCAL 2 DEC 79, TEHRAN
TIME (Z130Z), AND IS DATE/TIME THAT GROUND RECOVERY FORCE
ASSAULTS COMPOUND TO RESCUE HOSTAGES.
- (TS) RULES OF ENGAGEMENT (ROE) IN ACCORDANCE WITH
ANNEX A.
- (U) (TS) ALL OPERATIONAL PLANNING WILL MAXIMIZE NIGHT
OPERATIONS.
- (U) (TS) DIRECT LIAISON AUTHORIZED ALCON. HOWEVER,
MESSAGE TRAFFIC WILL BE ROUTED AS FOCAL POINT, NEED TO KNOW,
SENSITIVE.

4. (U) ADMINISTRATION AND LOGISTICS.

A. (U) PUBLIC AFFAIRS.

~~SECRET TOP SECRET~~

(u)
(b) ABSOLUTELY NO INFORMATION REGARDING THIS OPERATION WILL BE RELEASED BY ANYONE WITHOUT NSA APPROVAL.
(c) ALL QUERIES RECEIVED BY JTF PERSONNEL WILL BE ANSWERED AS FOLLOWS:

A
[REDACTED]

B. (U) PERSONNEL

(1) (U) PERSONNEL AND ADMINISTRATIVE SUPPORT WILL BE PROVIDED IAW SERVICE POLICIES AND PROCEDURES.

(2) (U) CASUALTY REPORTS WILL BE PREPARED AND SUBMITTED IAW SERVICE DIRECTIVES AND PROVIDED TO JTFHQ, (ATTN: J-1).

(3) (U) GCM AUTHORITY IS COMJTF.

(4) (U) ATTACHED/ASSIGNED FORCES WILL PROVIDE A ROSTER OF ALL DEPLOYING PERSONNEL VIA SECRET CODEWORD MESSAGE TO JTF, J-1 PRIOR TO DEPLOYMENT FROM HOME BASE OR STATION.

C. (U) MEDICAL. SEE ANNEX F.

E. (U) COMMAND AND SIGNAL.

~~TOP SECRET~~

~~CONFIDENTIAL~~

J (60)

FACT SHEET

SUBJECT: RH-53 Helicopter Capability

NUMBER IN CONUS: 22

RANGE:

- Unrefueled range: Approximately 575 NM
- Can be extended up to 1,000 NM maximum ferry range by adding up to six internal fuel tanks.
 - This would use up its extra weight carrying capability (passenger or cargo).

CRUISING SPEED: 130 Knots

FUEL CAPACITY:

- Two droppable external tanks (600 Gal. each).
- Up to six additional internal fuel tanks (Can be added in exchange for weight carrying capacity).

REFUELING:

- Air to air
- Ship to helo

ARMAMENT: Two .50 Cal. machine guns.

ARMOUR: Around seats, critical engine and hydraulic areas.

COMMUNICATIONS: FM, HF, UHF

PASSENGER CAPACITY:

- Normal: 38 PAX
- Emergency: 50+ PAX

SPECIAL CONSIDERATIONS:

- Partial disassembly required to deploy to forward staging areas in C-5 (Two RH-53 per each C-5).

~~CONFIDENTIAL~~

Classified By: JCS
Declassified On: OADR

Declassified by
JCS/MCJ
4 Aug 92

62

J

~~SECRET~~

A, G

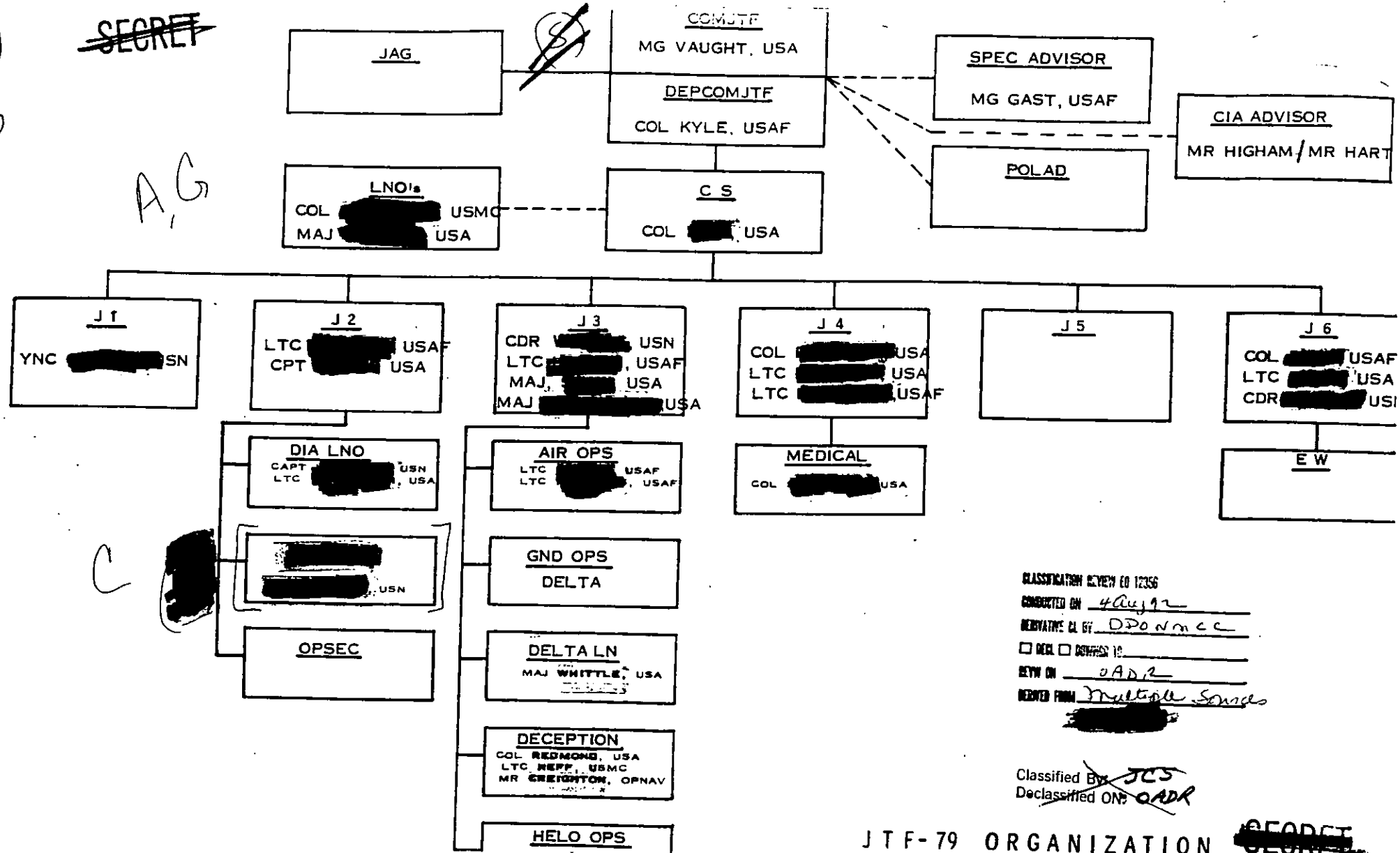

CLASSIFICATION REVIEW EO 12356
 CONDUCTED ON 4 Aug 92
 DERIVATIVE CL BY DPD/ncc
 DECL CONFESS 10
 REV ON 0ADR
 DERIVED FROM Multiple Sources

Classified By JCS
 Declassified ON: OADR

JTF EXERCISE

~~SECRET~~

③

DATE	DEPART TIME	LOCATION	ARRIVE TIME	LOCATION	TYPE ACFT	ACTIVITY
DEC MON	0900 CST	HURLBURT	1500 MST	DAVIS/MONTHAN	1 AC-130	POSITION FOR TUES JOINT TGN
DEC MON	1300 CST	HURLBURT	1730 MST	DAVIS/MONTHAN	2 MC-130	POSITION FOR MON & TUES EXERCISE
DEC MON		POPE AFB, NC	0900 MST 1100 MST	DAVIS/MONTHAN	2 C-141	ARRIVE D/M WITH BLADDERS
DEC MON	1900 MST	DAVIS/MONTHAN	2000 MST	YUMA DZ	1 MC-130	BLADDER DROP AT YUMA DZ
DEC MON	2001 MST	YUMA DZ	2030 MST	LUKE AUX #10	1 MC-130	DO COMM CHECK WITH HELO'S AIRLAND AND MARSHALL
DEC MON	2100 MST	LUKE AUX #10	2150 MST	DAVIS/MONTHAN	1 MC-130	RTB D/M CREW REST.
DEC TUES	1600 MST	DAVIS/MONTHAN	1700 MST	YUMA RANGE	1 AC-130	JOINT TGN WITH GROUND FORCE (DRY FIRE)
DEC TUES	1800 MST	YUMA RANGE	1900 MST	DAVIS/MONTHAN	1 AC-130	TURN FOR SECOND SORTIE.
DEC TUES	1800 MST	DAVIS/MONTHAN	1930 MST	YUMA DZ	2 MC-130	LOW LEVEL TO AIRDROP POINT - DROP BLADDERS TO HELOS
DEC TUES	1935 MST	YUMA DZ	2035 MST	DAVIS/MONTHAN	2 MC-130	TURN FOR SECOND SORTIE
DEC TUES	2230 MST	DAVIS/MONTHAN	2400-0030	YUMA RANGE	1 AC-130	JOINT TGN WITH GROUND FORCE (LIVE FIRE)
DEC TUES	2330 MST	DAVIS/MONTHAN	05/0030	LUKE AUX 10	2 MC-130	NIGHT ASSAULT FOR EXTRACTION
DEC TUES	0030 MST	YUMA RANGE	0130	DAVIS/MONTHAN	1 AC-130	RTB
DEC TUES	0130 MST	LUKE AUX 10	0220	DAVIS/MONTHAN	2 MC-130	RTB

~~SECRET~~

Classified By: J25
Declassified ON: OADR
10-1-2008

11C-130 ~~SECRET~~
Hurlbert with Sensor
Alignment and Bore Sight
Complete

AC-130
Schedule TUES

- 1400 alert, Brief
1600 DEP D/M for YUMA Range
1700-1800 TOT YUMA RANGE (1+00) (DAY DAY FIRE)
1800 DEP YUMA RANGE
1900 ARR D/M
} 3+30 GROUND TIME PRE
2230 Depart D/M for YUMA RANGE
2330 ON RANGE
2400-0030(s) WET FIRE TRAINING WITH DELTA
0030 Depart Range
0130 Land D/M RON crew Rest

Wed (s) make-up day - of not
required RTB HURLBURT WED

~~SECRET~~

AC-130 Departs Hurlburt
 after completing ground
 & organizational check WET
 DOWNSIGHT

JTF EXERCISE
 (AC/MC-130 PARTICIPATION)

~~SECRET~~

Low Altitude

DEPART TIME	(S) LOCATION	ARRIVE TIME	LOCATION	TYPE ACFT	ACTIVITY
0800 CST	HURLBURT	1500 MST	DAVIS/MONTHAN	1 AC-130	POSITION FOR TUES JOINT TGN
1300 CST	HURLBURT	1730 MST	DAVIS/MONTHAN	2 MC-130	POSITION FOR MON & TUES EXERCISE
	POPE AFB IL	0900 MST 1100 MST	DAVIS/MONTHAN	2 C-141	ARRIVE P/M WITH BLADDERS
1900 MST	DAVIS/MONTHAN	2000 MST	YUMA DZ	1 MC-130	BLADDER DROP AT YUMA DZ
2001 MST	YUMA DZ	2030 MST	LUKE Aux #10	1 MC-130	DO COMM CHECK WITH HELO'S AIRLAND AND MARSHALL
2100 MST	LUKE Aux #10	2150 MST	DAVIS/MONTHAN	1 MC-130	RTB J/M CREW REST.
1600 MST	DAVIS/MONTHAN	1700 MST	YUMA RANGE	1 AC-130	JOINT TGN WITH GROUND FORCE (DRY FIRE)
1800 MST	YUMA RANGE	1900 MST	DAVIS/MONTHAN	1 AC-130	TURN FOR SECOND SORTIE.
1800 MST	DAVIS/MONTHAN	1930 MST	YUMA DZ	2 MC-130	LOW LEVEL TO AIRDROP POINT - DROP BLADDERS TO HELO'S
1935 MST	YUMA DZ	2035 MST	DAVIS/MONTHAN	2 MC-130	TURN FOR SECOND SORTIE
2230 MST	DAVIS/MONTHAN	2400-0030	YUMA RANGE	1 AC-130	JOINT TGN WITH GROUND FORCE (LIVE FIRE)
2330 MST	DAVIS/MONTHAN	05/0030	LUKE Aux 10	2 MC-130	NIGHT ASSAULT FOR EXTRACTION
0030 MST	YUMA RANGE	0130	DAVIS/MONTHAN	1 AC-130	RTB

~~SECRET~~

J

TR 02 / 8600Z

MSG 002
DTG 021635Z
FM JTF FORWARD
TO: NCA
ETC

~~SECRET~~
SUBJECT EXERCISE CE01
(U) ITEM 1 INDEX

INDEX	ITEM NO
GENERAL INSTRUCTIONS	1
CALL SIGNS	2
SUFFIXES	3
RADIO NETS AND FREQUENCIES	4
CODE WORDS	5
CONTACT TELEPHONE NUMBERS	6
REAL WORLD SAFETY	7
ITEM 2 GENERAL INSTRUCTIONS	8

A. THIS CE01 IS EFFECTIVE FOR THE DURATION OF THE EXERCISE.
B. ALL COMMUNICATIONS WILL BE BY SECURE MEANS

PAGE 2
EXCEPT AS OTHERWISE AUTHORIZED IN THIS CE01.

C. KEYLISTS TO BE USED:
(1) PARKHILL KY 65/75 USKAT
(2) NESTOR KY USKAK
(3) HJ WILL BE AT 2400Z
(4) RADIO COMMUNICATIONS PROCEDURES.
(4) ALL TRANSMISSIONS WILL BE TRANSMITTED IN THE FOLLOWING MANNER WITH TIME INTERVAL BETWEEN REPETITIONS STRICTLY OBSERVED.
(1) ALL RADIOS TRANSMIT BY VOICE, WAIT FOR ACKNOWLEDGEMENT. IF NO RESPONSE HEARD WITH IN 30 SECONDS REPEAT TRANSMISSION AND WAIT 30 SECONDS. ON THIRD TRANSMISSION REQUEST ANY STATION HEARING CALL TO RELAY TO ADDRESSEE.
(2) ON HF COMMAND NET IF THERE IS STILL NO CONTACT AFTER REQUEST FOR RELAY BY ANY STATION IS MADE, SEND MESSAGE IN INTERNATIONAL MORSE CODE.

(5) ITEM 3 CALL SIGNS

NCA	CODE WORD
JTF	LOGGER
JTF ALPHA	MALLARD
SFGD D	VENTURE
MC SPECTRE	EAGLE
AC 130 SPECTRE	STAINWAY
RH 53 HELOS	RICOCHET
KITTY HAWK	FALCON
HEDEVAC	NOBLEMAN
U 2 AGN RELAY	SURVIVAL
(6) ITEM 4 SUFFIXES	POST STAMP

CDR	10
DEP CDR/AD	17
J1/J1	11
J2/J2	12
J3/J3	13
J4/J4	14
J6/CE OFF	16
CH OF STAFF	15
ACFT 1	1
ACFT 2	2
ACFT 3	3
ACFT 4	4
ACFT 5	5
ACFT 6	6

Classified by DDO NMCC
4 Aug 92
Declassify on: JAD R
Downgraded to CONFIDENTIAL
by DDO NMCC
4 Aug 9

CONFIDENTIAL

(S) ITEM 5 RADIO NETS AND FREQUENCIES

A. (S) PSC 1 UHF TACSAT NET, NON SECURE VOICE

(1) OPERATING STATIONS: JTF, DELTA, HELOS.

(2) SATELLITE CHANNEL: AFSAT 100 DEGREE W

(3) FREQUENCY: UPLINK 294.425 MHZ DOWNLINK 266.025 MHZ

B. (S) NSC 3 UHF TACSAT NCA NET

PARKHILL SECURED VOICE OR TTY, 75 BAND, KM 7 SECURED

(1) OPERATING STATIONS: NCA, JTF

(2) SATELLITE CHANNEL: AFSAT 100 DEGREE WEST

(3) FREQUENCY: UPLINK VMT 294.425 MHZ DOWN LINK REC 266.025 MHZ

C. (S) JTF HF COMMAND NET, HF SSR, UPPER SS, VOICE OR CODE (NON SECURE)

(1) OPERATING STATIONS: JTF, DELTA, HELOS, TALONS, SPECTRE, AEN RELAY

(2) CENTER FREQUENCY: 6000 KHZ

(3) OPERATING INSTRUCTIONS:

(A) THIS NET IS BACK UP FOR THE PSC 1 SATCOM AND STATIONS WILL BE ON LISTENING SILENCE EXCEPT WHEN AN EMERGENCY DICTATES TRANSMISSION AS DETERMINED BY THE COMMANDER MAKING SUCH TRANS. OSSOPM/

(E) THIS NET WILL BE USED AS REQUIRED WHEN DELTA STARTS THE ASSAULT AT WHICH TIME LISTENING SILENCE WILL NO LONGER BE IN EFFECT.

D. (S) UHF AIR/AIR; AIR/GND NET

(1) OPERATING STATIONS: DELTA, TALONS, HELOS SPECTRE

(2) FREQUENCY: 229.70

(3) OPERATING INSTRUCTIONS:

(A) THIS NET WILL BE USED FOR AIR TO AIR COMMUNICATIONS BETWEEN ALL AIR ELEMENTS. THE NET WILL BE NON SECURE. NETTOR WILL BE KEYED BY JOSE PERSONNEL PRIOR TO DEPARTURE FROM STAGING AIRFIELD. THIS NET WILL BE SWITCHES TO NON SECURE AT THE TIME DELTA STARTS THE ASSAULT. THIS WILL ALLOW UHF COMM WITH DELTA.

(B) THIS NET WILL ALSO BE USED FOR AIR TO GROUND COMM WITH DELTA IN THE CLEAR (NON SECURE) MODE DURING THE FUEL DROP AND UPON START OF THE ASSAULT.

E. (S) VHF/FM GROUND/ GROUND; ALTERNATE AIR/GROUND

(1) OPERATING STATIONS: DELTA, TALONS, HELOS, SPECTRE

(2) FREQUENCY: 38.90 MHZ

(3) OPERATING INSTRUCTIONS:

(A) THIS NET IS NON SECURE AND IS PRIMARILY DELTA GROUND TO GROUND NET. IT WILL HOWEVER, BE MONITORED BY ALL ELEMENT BECAUSE IT IS THE ALTERNATE AIR GROUND NET BETWEEN DELTA AND AIR ELEMENTS

BT

RR2

NNNN

Special Base Operations

CH-53 - ~~...~~
AC-130 - ~~...~~

CH-53 - ~~...~~ Crew to ~~...~~ and ~~...~~
~~...~~ ~~...~~ ~~...~~ ~~...~~

AC-130 - ~~...~~ ~~...~~ ~~...~~ ~~...~~

AC-130 - ~~...~~ ~~...~~ ~~...~~ ~~...~~

Medical Personnel - ~~...~~ ~~...~~

(S) Mount to Operation Area

CH-53 - C-141 ~~...~~ to ~~...~~ ~~...~~

C ~~...~~ - C-130 ~~...~~ ~~...~~
C-141 ~~...~~ to ~~...~~ ~~...~~
CH-53 ~~...~~ to ~~...~~ ~~...~~

CLASSIFICATION REVIEW ED 12356
CONDUCTED ON 4 Aug 92
RECAPTURE BY DDO/MCC (2 Dec 79)
 ~~...~~ Secret
REVIEW ON OADR
REMOVED FROM ...

~~SECRET~~
~~SECRET~~

Classified By: JCS
Declassified ON: OADR

~~SECRET~~

AC-130 - 2-19-79 - 11:30 AM - 1630 MST
AC-130 - 2-20-79 - 11:30 AM - 1630 MST

AC-130 - 2-21-79 - 11:30 AM - 1630 MST
(3 Dec 79) 11:30 - 1630 MST

AC-130 - 2-22-79 - 11:30 AM - 1630 MST
(3 Dec 79) 0800L (CST) ETA 1600L (MST)

Medical Personnel - two drivers and one assistant to be pulled up at Eggers AFB and moved to Langley. C-141 from Langley to Eggers. (Same flight as before).

JCSF - C-141 from Maxwell AFB to Langley
(30 Nov)

~~SECRET~~

Summary of Operations

(U) Helos with Delta should launch some amount of forward training, forward with some part of Delta trucks. (1500 hours)

(U) - Helos fly for 1 hour and land Point Base. Point Base will issue as the refueling site. (1900)

(U) - Helos fly out DZ for refuel drops. (30 min)

TO, 1800 L MST

(U) - Two MC-120's drop fuel bundles at Point Base. (1930)

TOT - 1930 L (MST)
RTB - 2030 MST

(U) - Refuel Helos. (3 hrs)

2/RTD - 2300
LUKE AUX-10 3/0000
RTD 3/0130
RTB DVA 3/0230

(U) Helos left off and transit to point cluster for drop off of Delta (2300)

(U) - Helos transit by truck to forward area

(U) - Helos remain to forward.

(U) 2400 Delta still Embury

~~SECRET~~

ETD -
2230

(2400-0000) - RTB DM - 70145/0200 RON
ETD 3/1400 HURO - 8/0001 MMC

- (U) - Helo returns with no load for entry extraction (0015)
- (U) - Helo extraction appears to be and ground to full auxiliary field 10.
- (U) - Mc-130 land ~~DM~~ 0000

(U) Helo land full 0100 and off load Dist. for extraction by Mc-130's.

(U) - Mc-130's Depart ~~DM~~ 0130

(U) - Mc-130's arrive ~~DM~~ AFIS DM (0400)

~~SECRET~~



~~SECRET~~

6 October 1980

66

THE JOINT STAFF

MEMORANDUM FOR MAJOR GENERAL VAUGHT

Subject: The Truck Option

1. (U) (TS) The US military holds relatively few Soviet-built trucks. A list of these trucks, indicating which models are also in the Iranian inventory is provided at TAB A.
2. (U) The majority of these vehicles are considered to be in "running" condition by the units that own them. However, it is unlikely that these vehicles could reliably be driven 75-100 miles without a major mechanical failure. For such a trip, the vehicle would first have to undergo a major overhaul, which would be difficult to accomplish since spare parts are at a premium.
3. (U) (TS) The most prevalent Soviet-built trucks in the Iranian inventory are the GAZ-66 (TAB B) and the UAZ-69 (TAB C). The US military has no GAZ-66 and only 1 UAZ-69. The Egyptians have many, although their state of repair and reliability is unknown.
4. (U) (TS) The Iranians do have in their inventory several models of US military vehicles, e.g., 1/4 ton, 3/4 ton, and 2 1/2 ton trucks, along with various combat vehicles.
5. (U) (TS) Considering the war environment that currently exists, the presence of military convoys of mixed, well-used, and damaged vehicles is probably not uncommon.

Conclusions:

1. (U) (TS) Preparing 4-5 of the Soviet-built trucks currently on-hand in CONUS would be a major maintenance endeavor. A complete overhaul of each vehicle would probably be required before any guarantee of reliability could be given.
2. (U) (TS) ~~_____~~ Bringing them up to a satisfactory maintenance level would be simpler than upgrading the Soviet vehicles currently in our inventory.

A
E

CLASSIFICATION REVIEW EO 12356
 CONDUCTED ON 4 Aug 92
 DERIVATIVE CL BY DDG NMC
 DECLASSIFIED DOWN TO Secret
 REVIEW ON OADR
 DERIVED FROM Multiple Arms

~~TOP SECRET~~
~~SECRET~~

Classified By [Signature]
 Declassify ON: OADR

~~TOP SECRET~~ A

(B) (C) (D)

3. (U) (TS) Preparing US built ground vehicles for the mission would require little more than repainting and a thorough mechanical inspection and field test.

Recommendations:

- 1. (TS) [REDACTED]
- 2. (TS) [REDACTED]
- 3. (TS) [REDACTED]

A
E
A, E

Richard B. Friedel
RICHARD B. FRIEDEL
Major, USA

~~TOP SECRET~~

<u>VEHICLE</u>	<u>LOCATION</u>	<u>CONDITION</u>	<u>IN IRANIAN INVENTORY</u>	<u>REMARKS</u>
ZIL-157	Ft. Huachuca	Running	Yes	Shop van
ZIL-157	Bolling AFB	Not Running	Yes	Has not been run in 1 ye
ZIL-131	Ft. Huachuca	Running	Yes	Only approximately 50 in Iranian inventory
ZIL-131	Vicksburg	Running	Yes	
UAZ-69	Aberdeen	Running	Yes	Jeep
KRAZ-255B	Aberdeen	Running	Yes	8-ton
GAZ-63A	Ft. Huachuca	Running	No	
UAZ-469B	Aberdeen	Running	No	
ZIL-130	Aberdeen	Running	No	
KRAZ-214B	Ft. Huachuca	Running	No	

~~TOP SECRET~~

UNCLASSIFIED

FORM-2320-2-4-73-5
NOMEN: TRUCK, CARGO, 2-TON, 4X4, GAZ-66

CATALOG: TM-301-5-22
(OLD 2-2320-2-73)
COUNTRY: U.S.S.R.
DATE UPDATED: 13SEP73

PRODUCER/ADOPTED: 1960-DATE/

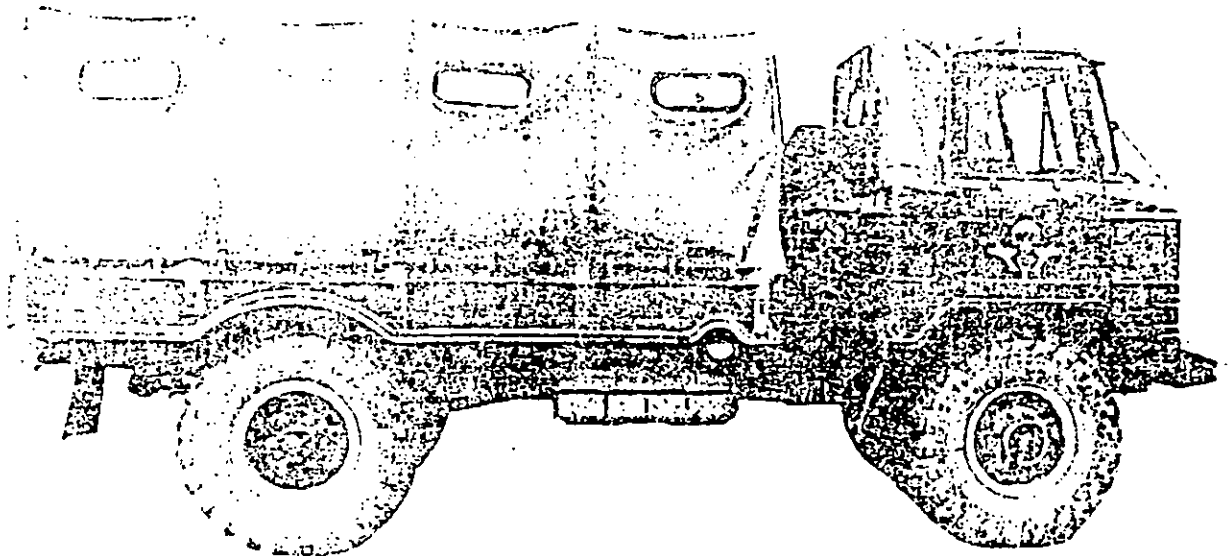

DATE CATALOGED: 01JUN67
VOLUME 22, PAGE 169

UNCLASSIFIED

FCM-2320-2-4-73-A
 NOMEN: TRUCK, CARGO, 2-TON, 4X4, GAZ-66

CATALOG: TB-331-5-22
 (OLD 2-2320-2-73)
 COUNTRY: U.S.S.R.
 DATE UPDATED: 13SEP73

PRODUCED/ADOPTED: 1965-DATE/

PHYSICAL DATA:

WEIGHT (KG)-
 -CURB ----- 3470
 -PAYLOAD OFF HWY ----- 2000
 -PAYLOAD ON HWY ----- 2000
 -PAYLOAD, WATER ----- N/A
 -GROSS OFF HWY ----- 5800
 -GROSS ON HWY ----- 5800
 -GROSS, WATER ----- N/A
 AXLE LOAD (KG)-
 -EMPTY FRONT ----- 2140
 -EMPTY REAR ----- 1330
 -LOADED FRONT OFF HWY - 2730
 -LOADED REAR OFF HWY -- 3070
 -LOADED FRONT ON HWY -- 2730
 -LOADED REAR ON HWY -- 3070
 PERSONNEL LOAD (NR) ---- 3 IN CAB
 MAX TOWED LOAD (KG)-
 -OFF HWY ----- 2000
 -ON HWY ----- 2000
 MAX SEMITRAILER (KG)-
 -GROSS ----- N/A

VEHICLE DIMENSIONS (MM):

LENGTH O/ALL ----- 5655
 WIDTH O/ALL ----- 2322
 HEIGHT O/ALL ----- 2440
 CARGO SPACE-
 -LENGTH ----- 3330
 -WIDTH ----- 2050
 -HGT OF SIDES ----- 890
 TREAD, C TO C-
 -FRONT ----- 1800
 -REAR ----- 1750
 WHEELBASE ----- 3300
 GROUND CLEARANCE ----- 315
 PINTLE HEIGHT ----- ?
 HGT TO C OF 5TH WHL --- N/A

PERFORMANCE:

MAX GRADIENT LOADED (PCT) -- ?
 TURNING RADIUS (MM) ----- 10.0
 FORDING DEPTH (MM) ----- ?
 FUEL CONS, LOADED -
 -ROAD (L/100KM) ----- 24
 -WATER (L/HR) ----- N/A
 CRUISING RANGE (KM) LOADED -
 -ROAD ----- 875
 -WATER ----- N/A
 MAX SPEED (KM/HR) LOADED -
 -ROAD ----- 90
 -WATER ----- N/A
 ANGLE OF APPROACH (DEG) ---- 42
 ANGLE OF DEPARTURE (DEG) --- 32
 VERTICAL OBSTACLE (MM) ----- ?
 TRENCH CROSSING ABILITY(MM) ?

REMARKS:

1/ GAZ-66 (VARIANT OF THE GAZ 13

ENGINE:

MODEL ----- *1
 TYPE ----- V8 JHV
 MAX HP AT RPM ----- 115 AT 3200
 MAX TORQUE (KGM) ----- 29 AT 2000-2500
 FUEL TYPE ----- GASOLINE (70-OCTANE)
 COOLING SYSTEM-TYPE - LIQUID
 BORE (MM) ----- 92
 STROKE (MM) ----- 80
 DISPLACEMENT (LITERS) 4.25

FCM NR ----- FUM 2605-2-1-8

GENERAL DATA:

TIRES-
 -SIZE ----- 12.00X18
 -PLY ----- 8
 -TYPE ----- ?
 -LOADED RADIUS (MM) - 505
 -INFLATION SYSTEM --- YES
 FUEL CAP (LITERS)-
 -MAIN TANK ----- 105
 -AUX TANK ----- 105
 BRAKES-
 -PRIMARY TYPE ----- HYDRAULIC (VACUUM ASSIST
 -PARKING TYPE ----- MECHANICAL
 SUSPENSION SYSTEM-
 -FRONT ----- SEMIELLIPTIC SPGS
 -REAR ----- SEMIELLIPTIC SPGS
 TRANSMISSION-
 -TYPE ----- MANUEL
 -NR SPEEDS FWD/RVSE - 4/1
 TRANSFER, NR SPEEDS --- 2
 LOCKING DIFFERENTIAL-
 -MANUAL ----- N/A
 -AUTOMATIC ----- YES
 ELEC SYSTEM (VOLTS) --- 12
 WINCH-TYPE ----- MECHANICAL, 2-SPEED
 -CAPACITY (KG) ----- 3500
 -CABLE LENGTH (MM) -- 50 M OF 12.5 MM CABLE



UAZ
69

ZIL
157

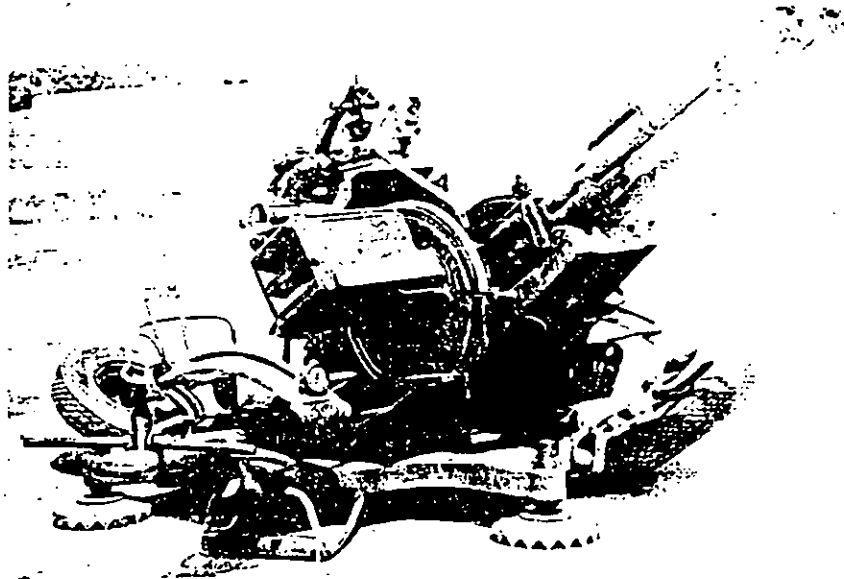

23-mm TWIN ANTI-AIRCRAFT GUN ZU-23

The Soviet twin AA Gun ZU-23, first shown in 1964, is a dual-purpose weapon suitable for employment in both an AA role (as its "ZU" designation implies) and in an equally formidable direct-fire ground role against personnel and light armor. It is mounted on a towed light two-wheel chassis with disk-type wheels which tilt outward at the top when the weapon is emplaced, thus providing freedom of movement around the gun as well as removing the weight of the gun from the wheels when firing. AA fire-control is by means of an optical-mechanical computing sight.

The ZU-23 is found in the inventories of East Germany, Poland, Hungary, Bulgaria, Cuba and Communist forces in Southeast Asia. Non-Communist recipients of the weapon include Egypt, Libya, Iraq, Iran, Afghanistan, Ghana, Morocco and Finland.

CHARACTERISTICS AND PERFORMANCE

Caliber	23-mm	
Length overall (firing position)	15.25 ft	4.68 m
Weight (overall)	1,968 lb	893.5 kg
Weight of gun	174 lb	78.9 kg
Elevation	-10° to 90°	
Traverse	360°	
Rate of fire (cyclic)	800-1,000 rd/min/gun	
Muzzle velocity	3,052 fps	930 m/s
Maximum range (horizontal)	22,960 ft	7,000 m
Tactical AA range	8,200 ft	2,500 m
Projectile weights (HEI-T)	0.41 lb	188 grams
(API-T)	0.42 lb	190 grams
Fuze type	Point detonating	
Armor penetration (est)	550 yd (500 m)	1,100 yd (1,000 m)
° obliquity (API-T)	0.96 in (24 mm)	0.76 in (19 mm)
Air transportable	Yes	
Fire control (AA)	None	
Off-carriage	Optical-mechanical computing sight	
On-carriage	Telescope	
Fire control (ground)		



~~CONFIDENTIAL~~

THE JOINT CHIEFS OF STAFF
WASHINGTON, D.C. 20301

J (70)

THE JOINT STAFF

25 July 1980

MEMORANDUM FOR THE AIR STAFF

Attention: AF/LERX

Subject: AN/PRC-90 Survival Radios (U)

1. ^(U) Request 120 day temporary loan of 40 each subject radios.
2. ^(U) Radios are required at Nellis AFB no later than 8 August 1980. Each radio should have one spare battery.
3. (U) Final details of loan (points of contact, date, time and location of transfer, etc) will be coordinated at action officer level.

G



Colonel, USA
Joint Test Director

~~CONFIDENTIAL~~

Declassified by
DDO/MCC
4 Aug 92
Classified By: JCS
Declassified ON: OADR



~~TOP SECRET~~

THE JOINT CHIEFS OF STAFF
WASHINGTON, D.C. 20301

~~CONFIDENTIAL~~

J (71)

THE JOINT STAFF

24 July 1980

MEMORANDUM FOR ALL

Subject: Analysis of Ice Box Timing

1. (TS) A review of the Option Nine timing concludes the following:

- a. Total time to execute: 3 hrs (2:52)
- b. Could be reasonably timed to 2.5 hours including pickups
- c. C-141 taxi time a major factor: 10 min. ea.
- d. Perimeter withdrawal a major factor: 30 min.
- e. [redacted] and assembly times shall be cut but is not going to be the major saver.

A

2. (U) (TS) There is an obvious need for more aircraft, thus more time to execute. It is essential to cut the time as much as possible.

3. (U) (TS) Study the message containing the actual times. Pass on any ideas you have on cutting times to Col. [redacted] or LTC. [redacted]

G

[redacted signature block]

Colonel, USA

~~TOP SECRET~~

Classified By: JCS
Declassified ON: OADR

Classified by DDONM
4 Aug 92
Declassify on: OADR

~~CONFIDENTIAL~~

~~TOP SECRET~~

Jcs P. t. may, GAST
HT: 1605F = ODDM

(G)

J 7
72

MFC
CS

JTC: 260, 5, 2604, 03, [REDACTED] (LWB)

23 JULY 80

[REDACTED] Meeting

MCIV - Intro: Consider Intel Aspects, the Purpose, STATUS of the Force
6 UNCS made: 1 LO83 NM, CHAT AS WELL (14 AVAIL). READY RE
REHEARSAL, A SPECIFIC SCENARIO. UNITS PREPARED FOR REHEARSAL (JUN 12)
25 AUG. CAN GO 3 WKS AFTER [REDACTED]

C

[REDACTED]

[REDACTED] PENETRATE OR [REDACTED] - ONLY TWO OPTIONS.

TO GO [REDACTED] DOESN'T BELIEVE IT [REDACTED] POSSIBLE - TOO MUCH TIME, MUST HAVE [REDACTED]
OF [REDACTED] FOR 2 WKS. [REDACTED] DON'T WORK [REDACTED]

ODOM - WILL ASK ZBIG & JIMMY FOR [REDACTED] COVERT O/M, [REDACTED]
OUR AMB KNOW. HE IS TO KNOW ONLY, [REDACTED]

[REDACTED]

CLASSIFICATION REVIEW ED 12356
CONDUCTED ON 4 AUG 92
DERIVATIVE CL BY D.D. NMCC
 DECL DOWNGR TO _____
REVW ON 1 ADR

~~TOP SECRET~~ Multiple Sources
Declassified on OADR

C, G

C, G

~~SECRET~~

J-76

SECTION 1
SECTION 2
SECTION 3
SECTION 4
SECTION 5
SECTION 6

~~_____~~

SUBJ: REAL ESTATE ACQUISITION.

THE FOLLOWING DATA IS PROVIDED:

ALL DATA WAS VOLUNTEERED BY SENIOR OFFICIALS OF THE RESPECTIVE FIRMS WHO HAVE CONTRACTS WITH VARIOUS ELEMENTS OF BOD.

~~_____~~

~~_____~~

CLASSIFICATION REVIEW EO 12356

CONDUCTED ON 4 Aug 92

DERIVATIVE CL BY DDON/mcc

DERIVATIVE DOWNGR TO Secret

REVIEW ON OADR

REMOVED FROM Multiple Smc

Classified By: JCS
Declassified ON: OADR

~~SECRET~~



THE JOINT CHIEFS OF STAFF
WASHINGTON, D.C. 20301

~~TOP SECRET~~
~~SECRET~~

23 JUL 80
Civilian

J- (77)

THE JOINT STAFF

23 July 1980

MEMORANDUM FOR THE CHAIRMAN, JOINT CHIEFS OF STAFF

Subject: Authorization for Civilian Contact (U)

G
A, E
A, E
D, E
G
C
A, E

1. (TS) Informal contacts with [redacted] have resulted in the following tentative proposals regarding the hostage situation:

(C) a. (TS) [redacted] is willing, as an anonymous private citizen, to place some of [redacted] at the disposal of [redacted] if such action would be of any value during the current situation.

(C) b. (TS) [redacted] organization retains [redacted] which [redacted] could tap.

(U) c. (TS) [redacted] is allegedly willing to fund any [redacted] activities on our behalf including [redacted]

(U) d. (TS) [redacted] desires to work with DOD only.

2. (TS) [redacted] has demonstrated a continuing and sincere desire to help us locate and free our citizens in any reasonable fashion. I trust and respect him and his judgement. Recommend we explore the possibilities more fully by direct liaison through members of my [redacted]. Request your authorization to proceed.

CLASSIFICATION REVIEW EO 12356
CONDUCTED ON 4 Aug 80
INITIATIVE OR BY DDORACE
 DECL DOWN TO Secret
KEY ON OADR
DERIVED FROM Multiple Sources

JAMES B. VAUGHT
Major General, USA

7/30

Approved _____

Disapproved _____

C

~~TOP SECRET~~
~~SECRET~~

~~TOP SECRET~~ ~~SECRET~~

The Operations Department as I believe that this proposal has merit but should only be accomplished through the [redacted] not independently and derive from DOD.

Classified By: [redacted]
Declassified ON: [redacted]

~~SECRET~~

EXMITTED: R7

COMMUNICATIONS
COMMISSION
2500 WASHINGTON AVENUE
WASHINGTON
D.C. 20540
OFFICE OF THE SECRETARY
[REDACTED]

C

[REDACTED] 11 AUG 1988

IT IS REPORTED THAT ON 8 AUGUST 1988 NATIONAL SECURITY
ADMINISTRATIVE APPROVED THE VETTING OF CONTRACTS MADE IN [REDACTED] BY
[REDACTED], SPECIAL ASSISTANT TO COMSTAF. THIS INFORMATION
WAS PASSED TO THE SECRETARY OF AOS AND WAS REPORTEDLY PASSED
AS WELL TO [REDACTED] BASED UPON THIS APPROVAL, [REDACTED] IS
PREPARED TO DEPART ON 10 AUGUST 1988 FOR [REDACTED]

REG

[REDACTED]
[REDACTED] THAT THE MISSION HAS BEEN APPROVED
[REDACTED]

G

11 AUG 88
01
[REDACTED]

~~SECRET~~



29 October 1980

THE JOINT STAFF

A ~~(S)~~ MEMORANDUM FOR [REDACTED] RANGERS

Subject: The E-3A in RDF and Special Operations

1. (U) The JTD AWACS component has drafted the subject paper for internal use when planning and conducting operations in support of the RDF, Inclosure I.

G 2. (U) Request all components review the subject document and provide critique comments and recommendations to OPR, Col [REDACTED], Commander 963 AWACS (TAC), Tinker AFB, OK 73145 (Autovon 735-6151, 6152, 4126). Use of the secure JTD message system is preferred method of communication. Comments are encouraged for improvement, correctness and best application of the contents.

3. (U) This is a working paper and must be returned to JTD upon completion of your review.

G

[REDACTED]

Colonel, USA
Joint Test Director

CLASSIFICATION REVIEW EO 12356
CONDUCTED ON 4 Aug 82
DESIGNATED BY DDON/mcc
REVIEWED BY OADR
REVIEWED BY Multiple Sources

CLASSIFIED BY JCS, J-3, JTD
DECLASSIFY 29 OCT 2000

[REDACTED]

~~-----~~
--DRAFT--

THE E-3A
IN
RAPID DEPLOYMENT FORCE
AND
SPECIAL OPERATIONS

COPY 6 OF 10 COPIES

--DRAFT--

DECLASSIFICATION
INSTRUCTIONS:

Classified by JCS, J3, JTD
Declassify: 29 Oct 2000

~~-----~~

~~SECRET~~

THE E-3A IN RAPID DEPLOYMENT FORCE AND SPECIAL OPERATIONS:
"BETTER KILLING ELECTRONICALLY"

I. INTRODUCTION: E-3A involvement in rapid deployment force (RDF) and special operations represents a logical progression in its evolution to realize its full potential as a tactical weapons system. Past exercises and contingency operations have conclusively demonstrated that an airborne warning and control system (AWACS) can be of substantial on-call assistance, as well as a pivotal resource manager, in a number of key roles within this dynamic and demanding tactical environment. Overall, the need presently exists to evaluate and enhance the capabilities of the E-3A AWACS organic electronic sensors and communications systems in order to best assist the onboard joint services commander in accomplishing his mission. Toward that end we present this material.

II. OVERVIEW: This paper discusses AWACS involvement in RDF and special operations from a general broad-brush perspective before examining the multiplicity of E-3A roles that have evolved as a result of recent developments. Though this information is primarily oriented toward the mission-ready aircrews aboard AWACS, other readers may also glean useful data about the E-3A and other systems involved. A definite hierarchy of tasks has emerged from current testing: Besides its primacy as a platform for comprehensive observation of the operational area, for long range surveillance, and for command and control of air-to-air assets (to include CAP placement and actual fuels management), AWACS has decisively established legitimate niches in other spheres. Chief among these are communications monitor/management of clandestine elements operating at low level and real-time reaction and assistance to other mission components due to fire support, refueling, search and rescue (SAR), and SIGINT inputs. Finally, on a time-or-task prioritized basis the E-3A can flight follow mission support and assault forces enroute to and from their objectives, enhance/refine their navigational precision, establish a communications relay capability, and generally provide an up-to-the-second summary of the situation for the onboard commander. The E-3A can provide short-notice assistance as well as continuing monitor and management of other mission elements. In all cases AWACS responsibility for the friendly air umbrella - the guarantee of an uncontested sky - must take precedence. Following a brief discussion of the pertinent principles of war, three major sections, the command and control of air-to-air resources, the E-3A organization for battle management, and the monitor/assistance of other mission elements, plus annexes, comprise this report.

III. GENERAL CONSIDERATIONS: Four principles of war that necessarily govern any RDF/special operation also characterize E-3A participation within such an environment:

SECRET

~~SECRET~~

A. SURPRISE. The ability to achieve one's objectives before one's adversary can react effectively; "an independent principle of itself, on account of its moral effect" (Clausewitz). The inherent flexibility and electronic agility of AWACS, coupled with its on-station endurance, make it a key player in orchestrating and achieving overall and simultaneous local surprise by friendly assault elements upon multiple objectives. These same E-3A capabilities also assist the entire force to maintain surprise during its ingress and egress phases and to remain beyond the reach of organized enemy pursuit or fixing forces.

B. SECURITY. Like surprise, a relative quantity, but one at which AWACS excels by providing early warning of a significant hostile threat by the E-3A's surveillance sensors and by subsequently positioning and committing friendly counter-air assets to defeat such enemy activity. This capability further allows the onboard commander the flexibility to array his tactical elements within the considerable latitude afforded by friendly air cover.

C. ECONOMY OF FORCE. AWACS radar, IFF, and communications monitors provide the data necessary for the commander to implement or modify his operations plan, contingent upon real-time observations and circumstances, in order to bring to bear a locally superior concentration of forces at the decisive point and time. This overall situational awareness gives him the tactical advantage, even with a force that may be numerically inferior overall.

D. TECHNOLOGY. [REDACTED] term, not Clausewitz'). Dr. Sam Colt's Single Action Army Revolver, the equalizer. The E-3A's considerable talents need to be continually explored, tested, and exploited in this area of ^{of} special operations in order to act in concert with the other principles. What follows denotes the methods, the "nuts and bolts" by which these guidelines have been applied to AWACS at the present time. These methods are still being adapted and refined through operational experience and aircrew ingenuity.

IV. E-3A/CAP C3; COMMAND AND CONTROL OF AIR-TO-AIR RESOURCES: The guarantee of a friendly sky gives the joint forces commander the inestimable advantage to ingress his forces unopposed, to carry out his ground tactical plans successfully, and then to egress intact and in good order; the E-3A represents the central means by which he can establish and maintain this air supremacy. By itself this capability would be reason enough to include AWACS in his order of battle, quite aside from the variety of monitor, relay, and management functions it can perform. As with every other component of a special operations force, detailed planning and painstaking execution characterize AWACS involvement

~~SECRET~~

to command and control fighter and tanker resources on CAP.

A. MISSION OF AIR-TO-AIR RESOURCES. In RDF/special operations the AWACS mission, its top priority, is to provide continuous air cover for friendly mission elements against hostile airborne threats in designated areas and for the duration specified by the joint forces commander.

B. AIR-TO-AIR PLANNING CONSIDERATIONS.

1. Enemy. Accurate, timely intelligence estimates of hostile capabilities and intentions in the area of interest are vital to AWACS establishing a realistic, workable air plan; these intelligence inputs, updated to the moment of aircraft launch, can determine the relative success of the covert, economy of force effort characteristic of special operations. G-2/J-2 estimates for CAP planning must include:

- a. EAOB (enemy air order of battle), both air-to-air and air-to-ground, locations, numbers, and operational status
- b. SAM and AAA locations and status
- c. Radar, surveillance (including ATC radar if significant) and GCI (ground control intercept) locations, status and their probable coverage for high and low-level detection and search
- d. (EEOB) expected ECM/ECCM capabilities, if any, in the target area that are able to affect AWACS radar/IFF sensor, voice/data communications links, or fighter fire-control systems.

~~_____~~ e. ~~_____~~ inputs to mission a flight crew (para IV E. 1.b.) provide the up-to-the-moment culminations of these earlier intelligence estimates; painstaking prior planning should preclude any nasty surprises once the operation is underway.

2. Friendly. The geographical area of interest and mission urgency often dictate the friendly air resources available to support an operation. Aircraft considerations by type that constitute constraints and significant planning factors normally include:

- a. Interceptors/air-to-air fighters:
 - (1) Type, number, and location (land or carrier)
 - (2) Armament - all aspect, stern only, guns, or special weapons
 - (3) Communications/guidance - voice only, data link (one or two way), and auxiliary receivers, secure capability
 - (4) Endurance/range - AR capable, whether boom or probe and drogue, loiter capability.

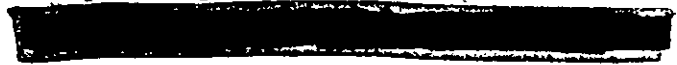

~~SECRET~~

b. Tankers: (Command Post/single point of contact must be established):

- (1) Type, number, and location
- (2) Communications - secure voice capability, HF (good for long range) equipped, SATCOM equipped
- (3) Boom or probe and drogue configured

c. Special (jammers, attack, reconnaissance, intelligence, SAR forces):

- (1) Availability for the mission
- (2) Necessity for participation
- (3) Considerations as far interceptors and tankers, plus evaluation of unique capabilities, also apply to these special air assets.

3. Weather. Basic considerations of weather's effects necessarily include the length and degree of darkness (sunset, sunrise, EENT, BMNT, and lunar data) as well as other estimates and predictions pertinent to E-3A command and control of CAP aircraft:

a. Weather prognostications for

- (1) Enemy interceptor/air-to-ground bases
- (2) E-3A orbit areas
- (3) CAP/tanker orbit areas
- (4) Recovery bases

b. Likelihood of thermal inversions that can affect

- (1) E-3A tactical ingress altitude, if the mission radar is to have adequate cooling (Para V. A.3)
- (2) Hostile GCI and search radar coverage, through ducting of the radar
- (3) E-3A mission radar, by the same ducting phenomenon

c. Significant through its effects on other mission elements besides the CAP are forecasted weather data such as

- (1) Local visibilities and associated obstructions such as haze, dust, or fog

~~SECRET~~

~~SECRET~~

(2) Surface temperatures and density altitudes that affect both fixed - and rotary-wing lift capacities.

Weather, seldom neutral during any given season or at any specific location, invariably offers subtle advantages that the commander can capitalize upon while minimizing the relative impact of its disadvantages upon his combat power.

C. AIR-TO-AIR CONCEPT OF OPERATION. Three major factors affect the air-to-air concept for special/RDF operations: The necessity to support the ground tactical plan, orienting and maintaining the air-to-air force (to include CAP ingress, egress, and interim fuels management), and detailed planning to meet contingencies. The latter does not imply built-in "slop" or "slack" factors, but rather the development of a sound concept incorporating the maximum flexibility possible under the principles of war governing such undertakings.

1. Supporting the ground tactical plan. Widely separated ground objectives may require the CAP force to

a. Operate autonomously and possibly covertly via Link 4A in order to support ground plans against targets a considerable distance from other objectives in closer proximity

b. Prioritize CAP coverage of objectives to be taken simultaneously

c. Time-phase fighter availability so that as many targets as possible can receive CAP coverage during critical phases of their assault or consolidation.

The final ground tactical plan defines the airhead to be sterilized against enemy aerial incursion. Consequently, the ground component has to complete its plan before AWACS can evaluate and plan the CAP air umbrella. Despite the time limitations this necessary delay can cause, AWACS planners can delineate the general boundaries of the AO for initial planning purposes; final inputs from ground components ideally should only fine tune this basic plan. Flexibility and simplicity keynote the final CAP product.

2. Orienting and maintaining the air-to-air CAP. This task, lasting the major part of the operation, requires a compromise among three interdependent factors of: AWACS location to provide the best surveillance/management coverage (with associated line-of-sight radio monitor capability) and CAP control, geographical positioning of CAP fighters for maximum ground support, and tanker location for accessibility/extended CAP duration. These three factors significantly affect the air-to-air force during its ingress, egress, and time on station phases.

~~SECRET~~

~~TOP SECRET~~

a. Ingress of CAP forces. On long hauls fighter and tanker routes and rendezvous can well be determined by their initial launch bases; AWACS may enter the area of interest at either high or low level, conditions permitting (para V.A.). In no case should the ingress of any element of the CAP force compromise the covert penetration of ground assault elements and their transport. A covert mission, to maintain surprise, should strive to stay undetected till H-Hour, the ground/airmobile assaults on the objectives; such an operation may thus need AWACS and CAP covers only from (H-Hour plus expected enemy reaction time).

(1) The advantages of an E-3A penetrating low level to accompany the rest of the ingress force need to be balanced against its relative disadvantages:

(i) The E-3A, if it is not to be solely dependent upon SIGINT inputs, must operate its mission radar to assist the rest of the force through an uncertain, ambiguous hostile environment.

(ii) This electronic emission, as well as the size of the target that AWACS presents to hostile search radars, may constitute an unacceptable risk to the rest of the ingressing force.

(iii) Reliable and [redacted] inputs (from disparate sources) could conceivably give sufficient threat data -- of a routine nature -- to AWACS and the ingressing force. The E-3A could then keep its mission radar "hot" but not radiating. Should [redacted] identify a short-notice threat, one specifically directed against the ingress force, the E-3A could come on line and pop to attain the necessary radar horizon for its sensors, turn on the mission radar within seconds, and proceed to handle the threat by active (interceptor vectors) and passive (nav guidance to the low level force) means.

(2) High altitude E-3A penetration, with or without other components of the CAP, reflects habitual AWACS procedures (and hence provides a characteristic "signature" to hostile defenses) and would also need to be orchestrated carefully:

(i) AWACS can provide extremely reliable high altitude pulse doppler surveillance without directly orbiting over a specific point (table in para V A.2.2. gives ranges); this advantage reduces its reaction time. BTH (beyond the horizon) radar mode, untested below 18,000 feet, pushes the AWACS high altitude range to a minimum of 340 NM.

(ii) Appearance of the E-3A upon hostile sensors signals the end of the purely clandestine phase. Opposition during egress can be the minimum expected reaction.

(iii) E-3A incursion into the area of interest has to be coordinated with its perceived utility. This utility has to consider its assistance to the commander for monitor, relay, and overall management as well as its primary mission of CAP command and control.

(3) Once on battle station, the E-3A may need to shift its random orbit in order to: [redacted]

~~SECRET~~

(i) attain surveillance coverage of probable high-threat areas, particularly those identified by SIGINT sources

(ii) maintain radar and radio contact with its fighters at their CAP positions (shifting CAP points is an alternate approach)

(iii) momentarily focusing its sensors and communications upon key areas, as directed by the onboard commander

(iiii) neutralize/counter hostile threats directed at AWACS.

(4) Fighter and tanker ingress routes do not have to parallel that of the E-3A; however, they should reflect the following guidelines:

(i) Both fighters and their tankers should "top off" to the maximum extent before ingress.

(ii) Fighters should, because of their limited duration, penetrate at high altitude in the band that gives them the best loiter time. Tankers could conceivably ingress on the deck; however, they would eventually have to climb in order to perform their main function and thus lose the advantage of tactical surprise. It is more likely that they will ingress within mutual supporting distance of their receivers, the CAP fighters.

(5) When AWACS, tankers, and fighters follow separate routes into the area of operations, rendezvous and recognition procedures must be coordinated during mission planning. Prior knowledge of each others' exact location, altitude, and activity provide the best means; security can be maintained by aircraft operating "IFF OFF" (though with OPORD codes set for momentary ID squawks) and communicating via secure means only by exception or upon explicit request. HOWEVER, IT IS BELIEVED THAT ANY VERY LOW ALTITUDE VEHICLES SHOULD STRONGLY CONSIDER SQUAWKING. The OPORD should specify the signals and procedures for covert aerial refueling and the AWACS fighter data link codes (para IV.D.2.d. contains typical examples).

b. Egress of CAP forces. Egress of the E-3A, tankers, and CAP fighters is inextricably tied to the withdrawal/retirement of other elements of the operation. In this phase absolute surprise has been lost, although the enemy may be uncertain as to the exact nature and disposition of the forces facing him. Mutual support of ground forces, their airlift elements, and each other becomes an active concern of the air-to-air component.

(1) This phase will test the soundness of the basis air-to-air plan. Assisting in SAR, defensive counter-air sorties, and protecting unscheduled ground or aerial refuelings of damaged/disoriented aircraft are reasonable and probable contingency missions during egress.

(2) Fatigue and the tendency to "let down" can be fatal. The operation does not terminate till the last bird, with the last trooper aboard, lands safely at a friendly base. These missions will be particularly exhausting for AWACS crews. The requirement for crew augmentation under such conditions could possibly limit the size of the onboard battle staff contingent.

~~SECRET~~

~~SECRET~~

c. CAP forces on Station. The effectiveness of air-to-air fighters in their orbits results from the dynamic equilibrium of four competing demands: their tactical location and orientation, their posture for timely response to probable threats, the necessity to support control (AWACS) and logistical (tanker) elements, and the requirement to wring maximum duration from the CAP birds by judicious fuels management.

(1) Ideally, CAP fighters should be positioned to give them the maximum tactical advantage against threat aircraft seeking to engage friendly mission elements. This normally requires them to be outside hostile ground based defenses but oriented to give enemy air the least possible time to engage their CAP.

(i) CAP position in large measure depends upon the development of intelligence estimates of the EAOB during the planning phase (para IV.B.1).

(ii) [REDACTED] via AWACS during the mission can alter these initial CAPS.

(iii) Mutual support between CAPs is desirable, even in an economy of force operation.

(2) Allocated fighter assets may not be able to bring decisive combat power to bear against each hostile threat identified beforehand. Requirements should be prioritized in this case; time-phasing of CAP cover can enhance its overall value to the operation.

(3) The necessity for CAP aircraft to support their control and logistical elements is a mutual one; all components are interdependent.

(i) Tankers gain a measure of security by having friendly fighters in their immediate vicinity, en route to and from CAPs and on the boom.

(ii) AWACS, since it retains commit authority for the fighters and manages the entire air picture, can initiate active and passive self-defense measures as analyses of the air picture suggest. AWACS security needs to be carefully balanced against the other needs for radar coverage of probable threat axes, contact with all other CAP elements, and radio/sensor coverage of the objective areas.

(iii) CAP birds are often subject to the personally frustrating decision to use them to protect other mission elements, and not to engage and kill enemy aircraft at random. In most cases, however, these two courses of action dovetail to insure air superiority.

(4) CAP duration is a function of fuels management; the link 4A utilization code for fighter communications includes brevity messages on this topic. In a covert environment AWACS must be a key player for maintaining a smooth flow between cap points and tanker orbits.

~~SECRET~~

~~SECRET~~

(i) E-3A controllers, given the data for fuel consumption of a fighter with a specific weapons mix, can anticipate refuel needs and forestall the need for radio emissions from their CAP birds.

(ii) By data link messages and command transmissions, AWACS can vector fighters to the vicinity of their tanker for covert AR.

(iii) AWACS overall situation awareness can maintain adequate CAP manning while still shuttling fighters on and off tanker.

(iv) Should CAP fighters become decisively engaged, the commander still has a de facto reserve available (within the flow of this fighter/tanker shuttle) to regain the tactical initiative and to retain his freedom of action.

3. Contingencies. Best met by the intrinsic flexibility of a simple plan, as well as by a thorough understanding of the roles and limitations of each player in the operation. If aerial problems do not yield to an inflight "quick fix", resources may have to be realigned in order to meet the demands of the situation. Informed decisiveness yields the best results in a fluid situations. The big picture, available only onboard the AWACS, depends upon its crew's maintaining situational awareness.

4. Coordination. This factor acquires disproportionate importance in air-to-air operations because of the complexity and time-dependent nature of key events (such as aerial refueling and relief on station) in CAP planning. Separation of participating units - fighters, tankers, AWACS-may preclude face-to-face discussions; communications may not permit secure transmission of timely amplifying data. Consequently, all players must rely on an extensive OPGRD and established standing operating procedures (SOPs) to resolve initial ambiguities. Useful OPGRD data for all units includes

a. Geographical information:

(1) CAP locations (lat/long), manning, altitude and duration

(2) Reference points enroute and on CAP, in lat/long

(3) Tanker data, locations (lat/long), AR times and altitudes, boom frequencies, call signs, off loads and E-3A orbit data.

b. Rules of engagement

c. Communications information:

(1) Secure key lists and date-time groups. CRITICAL

(2) Mode II and Mode III assignments for all players, normally by aircraft type & C/S (F-15 "Eagle 3" becomes 3/1503)

7
~~SECRET~~

~~SECRET~~

(3) Data link addresses for D/L equipped aircraft (normally the assigned Mode II plus a leading 0 or 1)

(4) Brevity codes, both voice and data link. The following is an example of an E3A/F14 link 4A utilization code:

E-3A/F-14 LINK 4A UTILIZATION CODE:				
ALTITUDE	HEADING	SPEED	MEANING	RESPONSE
35,000	As assign	.75M	Ops normal	Fly command
heading				
50,000		" "	Roll back	Fly command
heading				
60,000		" "	CAP A	Squawk flash Fly to CAP A
65,000		" "	CAP B	Fly to CAP B
70,000		" "	Go to Tanker	Fly command
heading				
75,000	090	" "	No tanker assets Available at present time.	None
75,000	270	" "	No tanker assets expected	None
80,000	As assign	.75M	Bandits at assigned heading. Do not engage or disengage	Flash
85,000	" "	" "	Engage bandits Engage and kill.	Fly Command Heading Squawk Flash
90,000	" "	" "	Alert - Msg follows	Standby for additional info

AFTER TASK HAS BEEN ACKNOWLEDGED, COMMAND ALTITUDE WILL BE DROPPED AND ACTUAL ALTITUDES ENTERED.

E. FLIGHT CREW INVOLVEMENT. The four crewmembers in the front end of the E-3A constitute an essential part to the team. The probability of flying over hostile territory makes it imperative that they maintain tactical awareness and be thoroughly proficient in E-3A active and passive defensive measures. Task loading, even momentary overtasking, of the mission crew may further require the front four to actively participate in various roles. In these tasks back-enders must conscientiously share information and coordinate their actions with the flight deck -- and vice-versa -- in order for all to perform smoothly as an integrated team. Possible front-end tasks include:

1. Monitoring and tuning flight deck radios, if not otherwise required, to enhance and extend the E-3A's electronic management/assistance capability:

a. Flight crew members and the Seat 5 occupant can listen to communications nets to alert the onboard commander or the battle staff to radio calls and to confirm weak or garbled transmissions.

~~SECRET~~

~~SECRET~~

d. This modification will provide a direct access SATCOM to the E-3A consoles; however, this advantage necessarily requires a change to the radio monitor arrangement depicted under para IV, B1:

(1) The HF monitor function at the DO Console will be lost in order to take full advantage of the direct access SATCOM link (using the organic AN/ARC-171 w/blade.)

(2) To retain an HF monitor requires that operator to have access to another console, possibly #30. This concession is more than overshadowed by AWACS gaining a reliable SATCOM capability that can be employed at short notice independent of the technical assistance of external agencies.

3. SATCOM Limitations. Satellite communications nets give the joint forces commander a considerable advantage over line-of-sight (LOS) systems, particularly when his elements are at low level in rough terrain. However, SATCOM is by no means a panacea:

a. A comm satellite actively retransmits, so it has only a fixed amount of power available ^{at its location} (assume 100 watts). Subscribers are time-shared, based upon their transmitted power. A single subscriber, whether a 5W portable set or a 1KW fixed installation, gets all of the satellite's 100W retransmit capability.

b. Multiple subscribers; eg., two - one at 4W and one at 16W - split the satellite retransmit capability by the ratio of their transmitted signal (here, 1 to 4, or 20 watts and 80 watts retransmitted power.)

c. As the competition for satellite retransmission intensifies - even with as few as 6 stations - the satellite becomes less efficient; RF energy is wasted, and the noise level rises severely. Just one station arbitrarily increasing its output can crump the whole satellite net; all stations are interdependent for SATCOM access.

d. Fixes include both short and long term methodology. In the 1984+ future, expect burst transmissions of data on magic gear currently being developed to optimize time sharing of SATCOM channels. For now, we need to:

(1) limit net size on SATCOM to alleviate competition for satellite power.

(2) use minimum power on SATCOM transmitters so that all subscribers - especially clandestine ground forces - get an equitable share of retransmit capability.

(3) enforce net discipline via brevity codes and transmission by exception; i.e., only when "things go sour".

(4) use the CPX prior to actual exercise kickoff to tune and adjust SATCOM nets for the full benefit of all players. Adherence to these procedures will keep SATCOM responsive to the special operations team.

~~SECRET~~

e. From a tactical consideration, the use of SATCOM versus conventional HF or UHF LOS means also needs careful evaluation:

(1) SATCOM communications, in addition to the limitations discussed earlier, are as susceptible to enemy triangulation and exploitation as conventional radio means.

(2) In fact, the increased radiation (transmitted power) from a SATCOM terminal makes it more likely to be intercepted and analyzed by hostile intel agencies.

(3) Whenever possible, conventional LOS communications are tactically preferable to SATCOM; reserve SATCOM emergency messages to be transmitted by selected element leaders over secure voice channels.

(4) Every attempt should be made to utilize a NAVY VHS or PR of missions.

C. CONSOLE CONFIGURATIONS. Since each E3A console - actually one of 9 remote terminals of the central computer - can be assigned a variety of electronic functions and up to 4 direct-access radios, AWACS possesses a built-in flexibility to perform time-critical management/assistance tasks while simultaneously fulfilling continual control and management requirements for friendly aircraft. Key battlestaff, not "tied" to a single console, are positioned to monitor the overall picture while still having access to mission radios. Considerable gains in efficiency have also been realized by forming weapons controllers and surveillance technicians into hybrid teams that can capitalize upon the skills and expense of each crewmember. The synergistic advantages of this cumulative knowledge exceed most expectations; after their initial exposure to the team concept, both controllers and surveillance techs prefer this task oriented approach to the traditional dichotomy of "weapons" versus "surveillance" sections. A recent team configuration has been as shown:

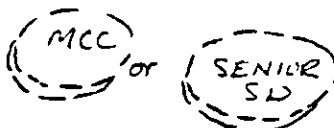

10 CAP CONTROLLER #1	21 CAP SURVEILLANCE TECH	25 CAP CONTROLLER #2
24 SENIOR DIRECTOR	01 WEAPONS DIRECTOR #3	06 AIR SURVEILLANCE TECH #3



30 SAR/AR WD #4	05 AST #4	04 AIR SURVEILLANCE OFFICER
-----------------------	--------------	--------------------------------------

~~SECRET~~

1. The arrangement of consoles 10, 21, and 25 reflects the predominant concern for maintaining continuous friendly air cover in the AO; AWACS dedicates two controllers and an AST solely to this task. This air-to-air team also controls aerial refuelings for its assigned interceptors, their CAP positioning, and the associated high-altitude tanker orbits.

2. The WD3/AST3 team (console 01 and 06) may, at the direction of the E-3A battle manager (CC) or the mission crew commander (MCC) working in concert with the joint services commander and his command center, monitor low-level or air assault events as the operation progresses. With such an orientation their focus normally proceeds through four distinct mission phases:

a. Ingress. Flight follow of mission elements to the vicinity of the objective area.

b. Assault/consolidation of objectives. Monitor/assist in time-phasing airmobile or airlanded elements; quick reaction to contingencies (go-arounds, fire support requests, message relay).

c. Actions upon the objective -- as required

d. Rollback and Egress -- navigational calls and refuelings of opportunity as the force withdraws/retires.

3. The WD4/AST4 team (consoles 30 and 05) assists other teams as directed during the normal progression of the operation. It can, in a fluid and uncertain environment, handle tasks such as SAR, AR, and medevac as required.

4. Note the flexibility this crew configuration affords the commander:

a. Battle Staff (MC, MCC, ASO, SD) are positioned for face-to-face contact and response.

b. Key players (MC, MCC) are able to observe and react to the total mission situation.

c. Both seated members of the battle staff (ASO, SD) have a crewmember in a parallel specialty (AST or WD) beside them to assist in case of momentary task overload.

5. Depending upon each operation, any row of three consoles can be relocated to provide the CC and MCC with the requisite data. For example, alternate arrangements could include

~~SECRET~~

a.

SENIOR DIRECTOR	WD #3	AST #3
CAP CONTROLLER #1	CAP SURVEILLANCE TECH	CAP CONTROLLER #2

MCC

ML

SAR/AR WD #4	AST #4	AIR SURVEILLANCE OFFICER
-----------------	--------	--------------------------------

b.

SAR/AR WD #4	AST #4	AIR SURVEILLANCE OFFICER
SENIOR DIRECTOR	WD #3	AST #3

MCC

ML

CAP CONTROLLER #1	CAP SURVEILLANCE TECH	CAP CONTROLLER #2
-------------------------	-----------------------------	-------------------------

~~SECRET~~

~~SECRET~~

c. Other configurations are possible, as well as judicious rearrangements within an individual row of consoles, depending upon the particular area of emphasis of the specific operation.

10 Min FM
D. SPECIAL TACTICAL COMMUNICATIONS. Communications nets, particularly the direct access radios routed to each specific mission team, can be monitored for situational awareness at appropriate stages or supplanted by other nets as the mission progresses. Recent experiences have validated the practice of pre-planning in detail such radio access; a mission crewmember on a particular team may have two or more copies of the External Communications Worksheet, each sheet specifying the radio nets corresponding to a major phase of the operation applicable and available to the team's consoles.

1. Ground FM nets. In addition to the SATCOM modifications to the E-3A, the ability for secure transmission and secure reception on the organic FM radio in the 27 MHz - 75 MHz spectrum has been a significant enhancement. Ground tactical forces habitually use this FM band to communicate with airborne support elements in their vicinity for pre-planned and on-call aid; AWACS can now monitor these nets and provide relay as needed between participants.

a. AC-130 spectre gunships, orbiting near the objective area, can be diverted or repositioned to provide direct fire (20mm, 40mm, 105mm) assistance to ground elements via requests on this FM secure air-ground fire support net. AWACS can monitor munitions expenditure, assist in target-gunship priority, and reallocate resources to meet the fluid demands of the situation.

b. Scout or armed helicopters use FM secure nets to establish contact (link-up) with ground forces on LZs or PZs as well as to control and shift any necessary supporting fires

c. The ability to monitor these air-to-ground nets provides the joint services commander a redundant back-up and a detailed confirmation of the big picture, the real-time situation display on the E-3A console and TV screen

2. Accountability. Certain raid or rescue operations may specify periodic radio reports in order to account for personnel and special equipment at isolated sites or on scattered objectives. AWACS, by virtue of its central location and favorable communications position, becomes the natural player to record and collate this data for higher echelons. The CEOI (Comm - Electronic Operating Instructions) normally contains the detailed procedures and assigned frequencies for such reports; a pre-printed form can then be used to tabulate this information.

VI. E-3A MONITOR/ASSISTANCE TO OTHER MISSION ELEMENTS: On a priority basis AWACS can monitor and assist various elements of the entire operation. When CAP level of activity permits, the E-3A can use its surveillance sensors and advantageous, line-of-sight, communications position to provide routine updates and time-dependent status information to the onboard commander. Further, on a real-time basis it can relay his directives responsively and

SECRET

~~SECRET~~

accurately to mission elements during contingencies.

A. OVERALL CAPABILITIES. AWACS can accomplish monitor and assistance tasks as required within these four major areas:

1. Flight follow of mission elements
2. Monitor/relay/record key transmissions
3. Respond/coordinate reaction to immediate requests for support.
4. Overwatch clandestine or low-altitude activity. With the command center onboard, AWACS possesses the straightforward ability to quickly analyze and authoritatively act upon data that its organic electronic sensors gather concerning progress of the overall operation.

B. SPECIFIC CONSIDERATIONS. The requirement for the least possible interference with and minimum disturbance of other mission elements keynotes E-3A approach to all these roles. Monitoring other forces does not require two-way, discrete radio links; AWACS must observe, listen, and transmit only as a last resort. Conversely, in an emergency, a mission aircraft or ground force leader should have the confidence (and ability) to transmit "in the blind" to the E3A to seek guidance. The relative tradeoff between the need to keep the commander informed and electronic compromise should be of continuing concern to all parties.

1. Flight follows. As a minimum, detailed planning and coordination with AWACS should include:

a. Details of the mission element's complete route, with critical times and altitudes indicated for timely track ID of the element during the entire operation.

b. Programmed IFF Mode II/III discrete squawks - on call or for emergency ID only. Once the mission loses complete surprise after the assault phase, aircraft should weight the advantages of overt squawking - rapid ID and consequent timely assistance against the possible security compromise it presents.

c. Requests and arrangements for navigational refinements or system updates (eg., PAVE LOW) from AWACS INS and OMEGA systems, subject to the precisions of both navigational systems.

(1) Updates, by exception only, should be by secure voice radio.

(2) Deviations from way points along the planned route can be broadcast in the blind by AWACS, with no acknowledgement necessary

d. Go-around (Calamity Jane) procedures can be expedited by AWACS direct observation of the event and by its subsequent monitor/relay assistance as needed on the ATC net between the combat control team and the aircraft involved (normally a UHF unsecure link).

~~SECRET~~

e. Egress routes may be substantially modified because of battle damage or maintenance difficulties. AWACS can flight follow egressing aircraft along their routes of opportunity and use its accumulated tactical information to provide vector around high-threat areas or weather disturbances on the route home.

2. Transmission monitor and relay. Based on the CEOI and the desires of the joint services commander onboard, E3A radios will normally tune from our net to another in order to monitor and relay key transmissions:

a. AWACS can, with its recent comm modifications, monitor every net used by every element on a time phased basis, to include secure/clear, HF-VHF-UHF, SATCOM/LOS and FM traffic. This capability gives the onboard commander timely updates independent of the delays imposed by relay through intervening echelons.

b. Crucial accountability reports (personnel and equipment) can be instantly monitored and collated on their appropriate nets (para V.D.2), collated, and analyzed by the command center and battle staff.

3. Response to immediate requests for support. Of all the systems involved, the E-3A normally possesses the most comprehensive, up-to-the-minute picture of the complete situation. Consequently, AWACS is usually the best position to orchestrate timely action upon short-notice requests. Should an actual operation rapidly diverge from its planned course, E3A onboard battle-staff may constitute the sole agency able to restore the overall concept and to establish priorities among competing requests for support. Typical requests would include:

[REDACTED] a. [REDACTED]

(1) Central computer memory in the E-3A can store and display such data (once entered) to construct a cumulative picture of enemy capabilities and intentions.

[REDACTED] (2) The degree of urgency of the [REDACTED] information will determine individual and overall force responses; mission elements may need vectors around newly active hostile areas or CAP aircraft may have to be diverted to counter an inbound airborne threat against a particular friendly element.

b. Fire support coordination (FSCoord) requests, normally on the ground-to-air FM secure nets (para V.D.1), can require AWACS participation as an active relay or as the fire support resource manager.

(1) E-3A crewmembers must be prepared to relay requests for fire to orbiting/inbound gunships.

(2) In an extended engagement, the E3A can request ammunition expenditures from gunships and adjust direct fire support resources, based upon established priorities and the directives of the onboard commander.

(3) For fire against targets of opportunity, AWACS' situational breadth permits it to make specific recommendations to the onboard commander

in order to cause the least perturbation to the overall fire support plan.

c. SAR requests to locate and extract friendly crews on short notice (see para IV. E. 2. for flight deck participation) should be implemented with minimum disruption to the progress of the mission.

(1) Precautionary landings by helicopters should adhere strictly to the SOP published in the OPOPD. In most instances a sister ship will land nearby to transport the downed crew and deal with the abandoned equipment.

(2) Other SAR scenarios may require timely, decisive action to resolve their circumstances.

(i) Airborne fire support assets or friendly airlift elements may require prompt diversion to the survivors' locations to effect a pick-up.

(ii) The AWACS SAR scope (para V C. 3) should be on call to direct SAR efforts until other mission elements arrive at the scene.

d. Requests for fuel resupply, both from aerial sources and pre-positioned caches, require AWACS managers to maintain a current tabulation of such reserves and their locations. Such logistical bookkeeping is particularly critical during force egress.

(i) Prior coordination is a must. Data on times, locations, quantities, and control frequencies must be disseminated to all uses.

(ii) Such preplanned events are very useful in contingency refuelings, either as known rallying points or for expedient modifications to the plan.

(iii) AWACS - dependent upon its CAP commitments - can assist in aerial refuel link-ups in a fluid situation.

4. Overwatch of Low-level clandestine forces. AWACS participation in recent exercises has led to the development of detailed procedures to identify, track, and assist helicopters and other slow-moving aircraft as they fly low-level routes across rough terrain. Because these shuttles and airmobile assaults can represent the critical focus of the operation, the culmination of the entire endeavor, it is imperative that the joint forces commander be able to monitor their progress and issue timely directives as needed. IFF transponders mounted on designated helicopters, currently provide the solution to this tactical problem. Passive means, such as corner reflectors, are also under consideration.

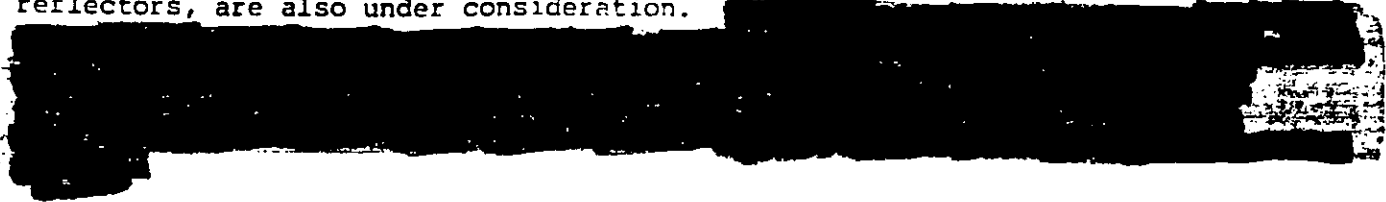

A, B

a.

[REDACTED]

(1)

[REDACTED]

(2)

[REDACTED]

(3) The unambiguous location and associated situational data that IFF affords the onboard commander is essential to his grasp of the real-time progress of his forces. Via FM secure radio nets, he can query his key players, the ground forces at the objective or PZ/EZ, the low-level helicopters, and the gunships in the vicinity, to orchestrate responses as required.

b. Helicopters and other low-level aircraft get best results by selecting their upper IFF antenna (as on the H-53). Some birds, such as the [REDACTED] may require modifications in order to top-mount an IFF blade. As a minimum, key command aircraft and individual flight leads should be modified.

c. Transponder settings should be coordinated in detail and understood by all elements.

(1) The Mode II setting, inaccessible for change during flight, reflect the aircraft type in its first two digits and its callsign in the final two (SABRE 05", an [REDACTED] would set 0605 for its mode II squawk; "GREEN 14", an H-53, would set 5314).

(2) Mode III can be changed in flight; consequently, it represents a potential means to relay key data by prearranged code settings. If possible, these settings should be able to be dialed in prior to take-off in not to distract or overburden the crew, particularly in single-pilot birds such as the [REDACTED]. Prearranged codes could transmit information concerning the numbers or status of personnel and equipment.

(3) Because IFF transponders operate on an octal system, arranged codes--and aircraft callsigns, if feasible--should use only the numbers 0 through 7. "8" and "9" or not available on IFF gear.

d. A typical low-level route is shown here

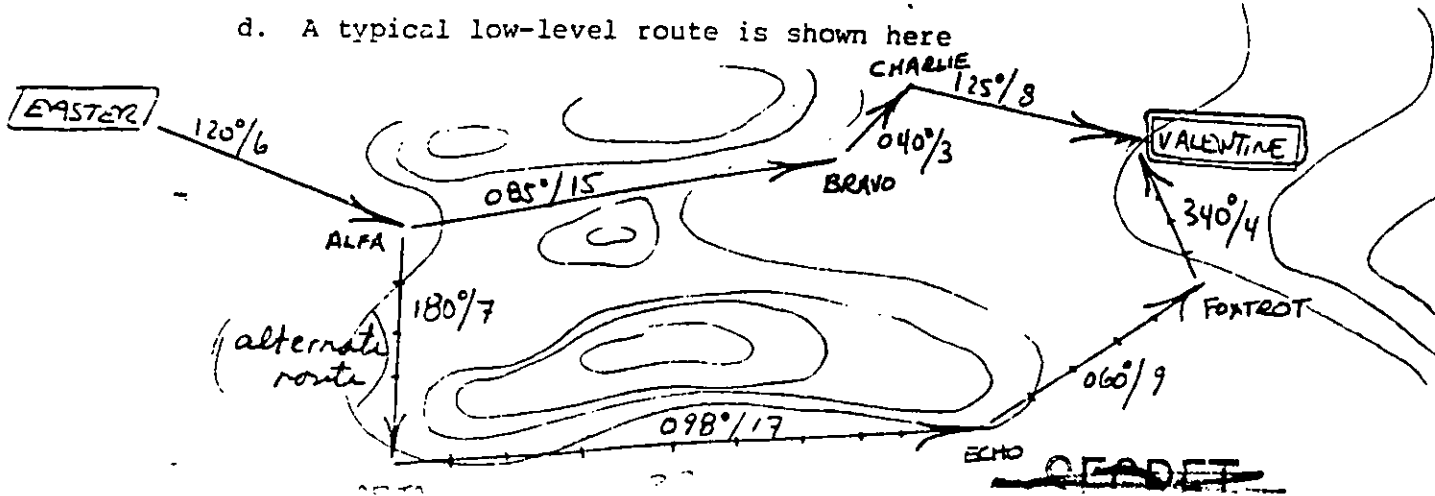

~~SECRET~~

The detail and amount of route information that the low-level commander can coordinate with AWACS beforehand determines the quality of assistance the E-3A can provide. Names of objectives/way points and bearing/ranges (or geographical coordinates) to delineate the route are particularly useful. AWACS also needs to be briefed on probable contingency plans and mission SOPs to be fully helpful to the little birds.

VII. SUMMARY: This paper represents the initial attempt to place between two covers the information, procedures, and techniques pertinent to AWACS participation in RDF/special operations. As a draft, this first approximation is susceptible to--vitally dependent upon--inputs from users at all levels to refine and enhance its pages; write or call criticisms and comments to:

G7

or

Col [REDACTED] CC

Maj [REDACTED], DOOM
963 AWACS (TAC)
Tinker AFB, OK 73145

(Autovon 735-6151, 6152, 4126)

~~SECRET~~

~~SECRET~~

9

ACCU LEVEL

F.L.	HORIZEN
100	123 NM
75	106 NM
50	87 NM
30	77 NM
25	67 NM
	61 NM

~~SECRET~~

~~SECRET~~

~~CONFIDENTIAL~~
AIRCRAFT FUEL CONSUMPTION RATES

A

~~CONFIDENTIAL~~
~~CONFIDENTIAL~~
HH-53 : 2000 lb/hr
6.0 hr endurance
450- and 650-gal jettisonable
AAR (pod) external
Tanks

AC-130 : 6200-6300 lb/hr
7.0 hr endurance
AAR (pod)

E3A : 250 lb/min, 15,000 lb/hr
AAR (boom)

F4E* : 100 lb/min, 6,000 lb/hr
AAR (boom)

* Note -- USN F4a use probe
and drogue for AAR

F14 : 4500 lb/hr @ FL350, 420 TAS
AAR (pod)

~~(S)~~ [REDACTED]

DATA

A, B

Gross Weight: [REDACTED]

Basic Weight: [REDACTED]

Troop Seats: [REDACTED]

Cruise Speed: [REDACTED]

Endurance: [REDACTED]

Range: [REDACTED]

Fuel Capacity: [REDACTED]

Fuel Consumption: [REDACTED]

CH 60 BLACK Hawk

MC-130

HC 130

C-141B STRETCH

~~HH-53~~
HH-53 PAVE LOW DATA

FUEL:

12,000 lb capacity
jettisonable tanks in 450 - and 650-gal sizes
endurance: 6 hr
consumption: 2000 lb/hr

COMMUNICATIONS: secure capability

1. HF (KY-65)

FM
2. VHF (KY-28)
UHF

IFF antennas - two -

SPEEDS: \approx 116 kt cruise

ECM: 1. flare and chaff dispensers
2. IR paint job

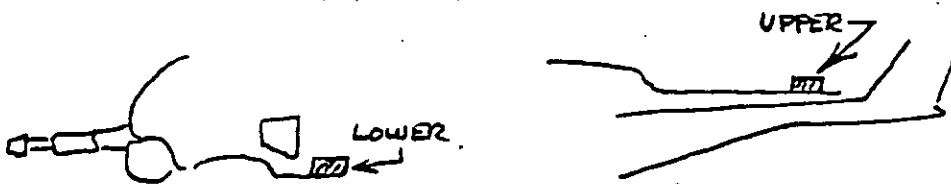

Either or both (the normal setting)
can be selected by the crew.

PAVE LOW (FLIR - forward-looking infra red) SYSTEM

1. mounted on o/c nose
2. flexible mount
 - 180° lateral mt
 - 180° vertical mt
3. adversely affected by
 - clouds
 - rain
 - heavy fogthat produce a uniform temperature gradient in the scanning area
4. FLIR cannot pick out
 - power lines
 - towersso thorough map recon of low-level route is necessary to detect obstacles
5. navigation - updates in lat/long or UTM

AC-130 SPECTRE DATA

FUEL: 42,000 lb capacity
(16,000 lb in external tanks adds 2 1/2 hr)
endurance: 7 hr
consumption: 6200-6300 lb/hr

COMMUNICATIONS: secure capability
SATCOM - DM (dome antenna) mounts
on flight deck escape
hatch

- 1 FM (KY-28)
- 1 UHF

SPEEDS: 1. 240 kts TAS at 10,000' (altitude-limited
for LOX system capacity)
2. 210 kts TAS at low-level
3. 150-160 kts TAS in firing orbit
ALWAYS LEFT HAND AT ALT

(A) SENSORS: 1. MULTI-SENSOR PACK, (L) side behind cockpit
a. flexible mount
b. low-light television
c. laser target designator
d. [REDACTED]

A

2. INFRARED SENSOR GIMBAL, (L) landing gear fairing, aft of 20mm.
-- 180° lateral movt
-- adj. also in vertical plane
3. APQ-15D, (L) side, aft of 40mm
-- X-Ray-type beacon
-- used for target designation

~~SECRET~~

AC-130 SPECTRE DATA [continued]

- (S) ARMAMENT:
1. 20 mm (3000 rds) -- 2500 rd/min rate
105 mm (100 rds, HE) -- 1 rd/min sustained firing rate
40 mm (464 rds) -- 100 rd/min
-- "MISH" rd is excellent incendiary for use on wooden structures or aircraft

2. Weapons can be trained to sensor ~~xs~~

3.

[REDACTED]

4.

[REDACTED]

5. Can fire using manual sight if computer becomes inop.

A, B

~~SECRET~~

~~TOP SECRET~~

JTF ✓ (78)
DRP
CS
10
JL RT



THE JOINT CHIEFS OF STAFF
WASHINGTON, D.C. 20301

THE JOINT STAFF

8 September 1980

MEMORANDUM FOR THE RECORD

Subject: Commercial Contacts

1. On 5 September 1980, Lieutenant Colonel [redacted] and Mr. [redacted] met with senior officials of the [redacted]

[redacted] The meetings took place in the offices of the senior officials. Both meetings were cordial and useful.

2. The [redacted] officials included:

These gentlemen provided the names and locations of [redacted] who may be of assistance. In addition, the corporation approved [redacted]

They will assist in [redacted] and lay the ground work for a [redacted]. The names/locations of the contacts are listed below:

[redacted]
[redacted]
[redacted]
[redacted] ****

NOTE: All possess knowledge of the [redacted] and of the two Iranians.

[redacted], he may be amenable for other functions.

~~TOP SECRET~~

CLASSIFICATION REVIEW EO 12356
CONDUCTED ON 4 Aug 91
DERIVATIVE CL BY DDD/mcc
 BEEL DOWNER TO Secret
REFN ON DADA
ORIG SOURCE Multiple Sources

3. During general discussions, [REDACTED]

[REDACTED] asked if we knew anything more about the "Stealth" aircraft revelations than what appeared in the press. We said our knowledge was essentially confined to press. [REDACTED] said he was curious because in the mid-to-late sixties, the [REDACTED] had developed and tested a "composite material airframe" which had such a small radar signature that FAA, for safety purposes, required that radar reflectors be added so the aircraft could be tracked during testing. Did not pursue the subject further but the thought occurred that if such material was available it might ~~aid~~ increasing the penetration capability of some of the [REDACTED] associated aircraft. Also during the same discussion, [REDACTED] mentioned a technique developed by the [REDACTED] which called for [REDACTED]

Instruments within the aircraft were thus able to detect [REDACTED]

[REDACTED] etc.. [REDACTED] said at the time the Army was not interested. Suggest someone from the OSD or USAF R&D community contact [REDACTED] and follow up on these two technologies, the former for possible use by [REDACTED] aircraft and the second for possible use by USAF reconnaissance forces charged with the requirement to locate Soviet/WP [REDACTED] during wartime.

4. [REDACTED] Topics of discussion were:

a. [REDACTED]

c. Arrangements for future debriefing of [REDACTED]

[REDACTED] Debriefing tentatively set for mid-week (Wed/Thur - 10-11 Sep).

[REDACTED]
Lieutenant Colonel, USAF

MEMO

[REDACTED]

MTG

5/9/8

[REDACTED]

IRANIAN WIFE

[REDACTED]

[REDACTED]

TECHNICIAN (photo)

[REDACTED]

- checking shipping out

~~TOP SECRET~~

~~CONFIDENTIAL~~

~~TOP SECRET~~

Key Future Contacts

①

[REDACTED]

([REDACTED])

[REDACTED]

②

[REDACTED]

X:XX

③

[REDACTED]

④ →

Bldg MAINTANCE [REDACTED]
CONN-

~~TOP SECRET~~

~~CONFIDENTIAL~~

C, G

for



J-79

28 July 1980

THE JOINT STAFF

MEMORANDUM FOR THE CHAIRMAN, JOINT CHIEFS OF STAFF

Subject: Proposed Insertion of an American Intelligence Asset into Iran [REDACTED]

1. (TS) The need to develop a viable in-country support structure for support of a military option is still considered critical. To assure this support structure's success, a great deal of information about security procedures throughout

C Iran, [REDACTED] is needed. One such effort to gain timely, first-hand information is being developed by my element. It involves the insertion of an American citizen in cover status into Iran.

(S)
2. (TS) This plan centers around [REDACTED]

C [REDACTED], realizing that preparation time would be needed.

3. (TS) Our current plan is [REDACTED]

C
4. (TS) [REDACTED]

[REDACTED] This concept does not require that either person know the other too well should one or both be questioned.

CLASSIFICATION REVIEW EO 12356

CONDUCTED ON 4 Aug 82

DERIVATIVE CL BY DDONmcc

DECL. EX. OWNER TO Secret

REVISED ON OADR

Classified By: JCS
Declassified ON: OADR

~~TOP SECRET~~ Multiple copies

5. (TS)

[REDACTED]

6. (TS) The driving time from [REDACTED] to Tehran, is [REDACTED]

[REDACTED] This is sufficient time for his collection mission and plausible from his cover standpoint. Thus, this phase of the operation will be over by 2 Sep 80.

7. (TS) I understand that SECDEF approval is required for insertion of an American citizen/asset into Iran. With that and the importance of time in mind, I am proceeding with all preliminary measures to insure this plan is sound. [REDACTED]

8. (U) This memo is for your information. Shortly, you will receive another requesting the Secretary of Defense's approval.

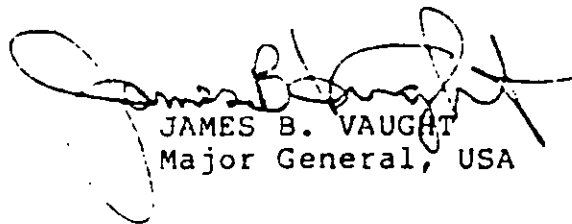
JAMES B. VAUGHT
Major General, USA

7/30/80

The Operations Agencies and I approve this concept. You should proceed with your memo of request.
The Hansen
VADM, USN



~~TOP SECRET~~
THE JOINT CHIEFS OF STAFF
WASHINGTON, D.C. 20301

6-7-8 Aug 80
Humint / DoD

MEMORANDUM FOR THE SECRETARY OF DEFENSE

Subject: SNOWBIRD Support ~~(TS)~~

1. (TS) The development of a viable in-country structure for support of a military option is being pursued. We have screened and selected DOD assets and our posture in this effort is much improved. One such plan to obtain in-country data, which is greatly needed, is outlined below. Because it involves inserting an American citizen into Iran, your approval is required.

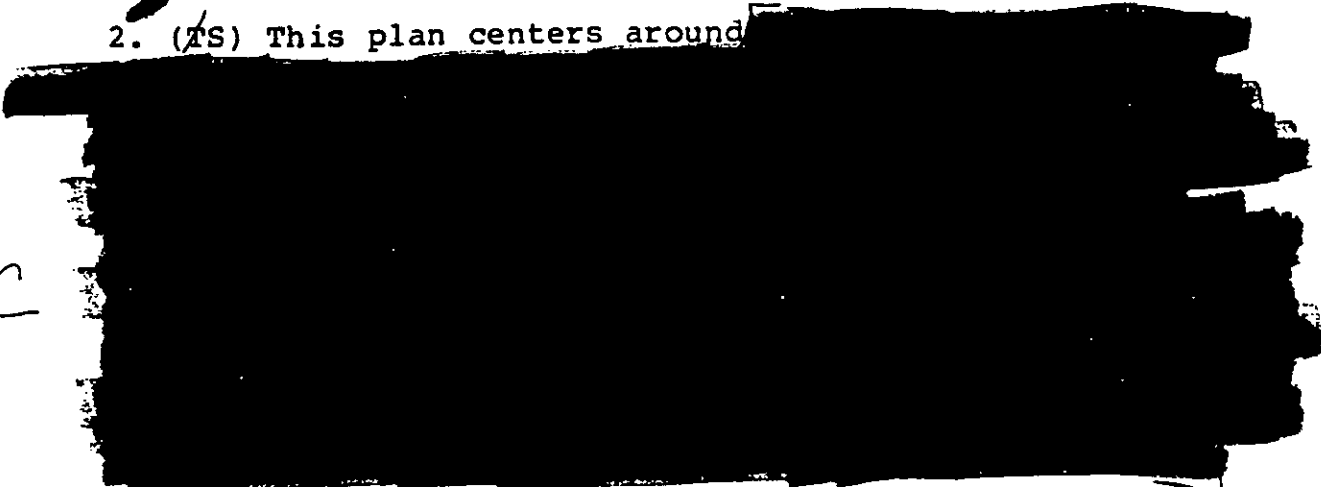
2. (TS) This plan centers around 

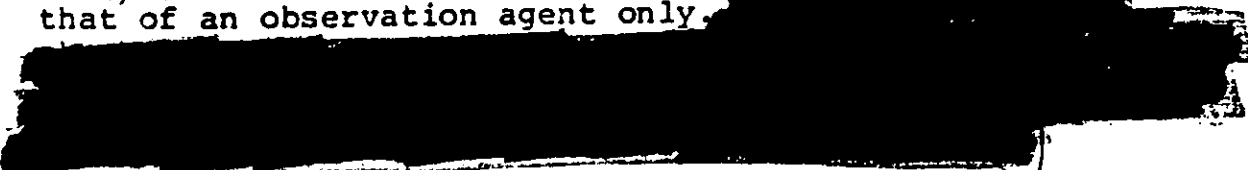
3. (TS) Our insert's intelligence collection mission will be that of an observation agent only. 

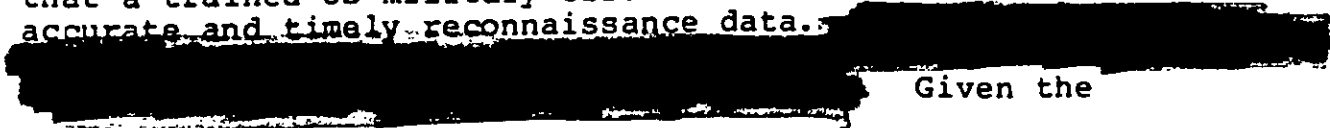
4. (TS) Our experience in RICE BOWL clearly demonstrated that a trained US military observer is the best source of accurate and timely reconnaissance data. 

Given the

~~TOP SECRET~~

~~TOP SECRET~~

training program and cover development already underway, I believe that the projected mission has a high probability of success with relatively low risk.

(U) 5. (U) This memorandum is for your approval.

~~TOP SECRET~~

7 Aug 80

~~TOP SECRET~~

Mon -

From a policy stand -
point I do not approve
this proposal unless it
is carried out by the
Executive Agent for the
Secretary of Defense - the
Department of the Army -
operating under the
provisions of DoD

Directive 5-5105.29 dated
1 December 1978. I strongly
recommend that the
Joint Staff stay out of



~~TOP SECRET~~

~~TOP SECRET~~

Clandestine intelligence
operations. *

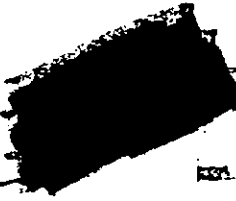
~~TOP SECRET~~

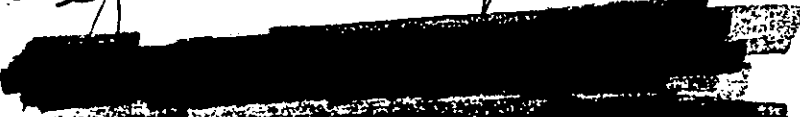
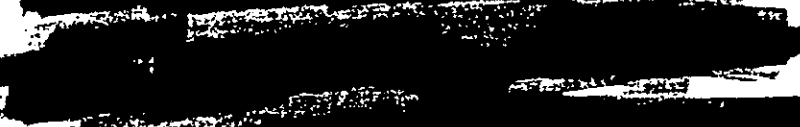
* If time is problem 



 - even then I do
not believe an American
military man should be
inserted.

~~TOP SECRET~~

THE JOINT CHIEFS OF STAFF
OFFICE OF THE DIRECTOR, THE JOINT STAFF
WASHINGTON, D. C. 20301

~~TOP SECRET~~

8/8/80

The Operations Directorate,
considering the DIA
Director's comments, do
not recommend that this
agent be inserted. [REDACTED]

[REDACTED]
Should this man be
killed or captured, DOD
would be in an unacceptable
situation.

Thor Hanson

THOR HANSON
VICE ADMIRAL, USN
DIRECTOR, JOINT STAFF

~~TOP SECRET~~

THE JOINT CHIEFS OF STAFF
OFFICE OF THE DIRECTOR, THE JOINT STAFF
WASHINGTON, D. C. 20301

~~TOP SECRET~~

5/9/80

CJCS noted the Ops Dept

+ DIA concerns [REDACTED]

[REDACTED]

This should be
arranged through Gen. Tigher.
Thor Hanson

THOR HANSON
VICE ADMIRAL, USN
DIRECTOR, JOINT STAFF

~~TOP SECRET~~

OJCS SUMMARY SHEET

~~SECRET~~

TO: CJCS	CLASSIFICATION TOP SECRET	FOR USE BY ORIGINATING DIRECTORATE			
THRU:		DJSM NO.	ODJS SUSPENSE DATE		
		DJSM DATE			
SUBJECT: SNOWBIRD Support (TS)		ACTION			
		APPROVAL	SIGNATURE	INFORMATION	OTHER
		X	X	X	

REMARKS

1. (TS) The attached memorandum requests permission to provide an American citizen, [redacted] into Iran to gather data about [redacted]. Hopefully he will be able to acquire some information [redacted] and upon his departure, [redacted]

2. (TS) This mission will be that of an observation agent only.

3. [redacted]

[redacted] will be completed upon Secretary of Defense's approval.

5. (U) Recommend memorandum be approved and forwarded to the Secretary of Defense.

* Memorandum for the Director, Central Intelligence
Subject: SNOWBIRD Support (S)

ACTION OFFICER	COORDINATION/APPROVAL					
	OFFICE	NAME	EXTENSION	OFFICE	NAME	EXTENSION
Col, USA J-3, SOD Ext 54087						
DATE OF PREPARATION 1 Aug 80						

~~SECRET~~

~~TOP SECRET~~
~~TOP SECRET~~

J-80

Item Number: _____

Intelligence Historical Report
J2, JTF 1-79

CLASSIFICATION REVIEW EO 12356
CONDUCTED ON 4 Aug 92
DERIVATIVE CL BY DDI/MC
 BECL DOWNGR TO _____
DEYN ON OPDR
DERIVED FROM multiple sources

SUBJECT: E-3A (AWACS) Intelligence Support

TIMEFRAME: September 1980

SUMMARY:

1. (U) COMJTF determined that AWACS should support probable SNOWBIRD options and would be integrated into SNOWBIRD planning. Two J2 personnel traveled to Tinker AFB, OK, to participate in a SNOWBIRD training exercise in which AWACS was used. They determined the type of intelligence support that could be provided by AWACS systems and analyzed the physical arrangement of the aircraft interior to estimate how J2 could arrange its operations.

2. (E) The ^{primary} ~~planning~~ function of AWACS is operational rather than intelligence oriented. By using its 9 radar scopes and its sophisticated electronic equipment, AWACS can track all aircraft traveling [redacted] or greater, or that are using IFF, within an approximately 250 nm radius. (Radius can be extended under certain circumstances.) Using ~~the~~ ^{this} capability, AWACS mission crew can monitor all friendly and enemy aircraft in the area of operations, direct any SAR effort, ^{act as Airborne Controlled Intercept} ~~act as an ACI~~ against enemy aircraft, maintain fuel consumption data for friendly aircraft, control aerial refueling operations, and serve as a command and control platform.

A, E

~~TOP SECRET~~
~~TOP SECRET~~

Classified By: JCS
Declassified ON: OPDR

3. (U) AWACS will not perform true intelligence collection operations during mission execution. Although AWACS will be able to determine when enemy aircraft launch from bases within the range of its electronic equipment, this data will be "battlefield information," immediately applicable to the on-going combat operations rather than the intelligence data base.

4. () Therefore, the primary functions of J2 personnel on the AWACS during mission execution would be to receive and assess current intelligence received by secure radio and to plan for contingencies that could arise prior to mission end. Sufficient room is available for 1-2 intelligence personnel on the aircraft, and sufficient wallspace is available for required graphics to support ~~these~~ ^{these} ~~missions.~~ ^{functions.}

COMMENTS:

1. (U) ~~AWACS~~ AWACS is a superb aircraft for operational control of friendly aircraft and as a command and control platform. It is adequate for intelligence operations in support of an airborne command post. The intelligence operation, however, must be austere due to physical space limitations. The J2 deployment list must be carefully reviewed to eliminate extraneous items, while, at the same time, ^{insuring that} ~~the list must include~~ all possible materials that could be required for contingency planning ^{are included.}

2. (rscw) Under SNOWBIRD planning, [redacted] intelligence data would be transmitted from CONUS by secure voice radio to J2 personnel aboard AWACS. Some individuals feel that this is a cumbersome and slow means of relaying critical intelligence material [redacted]. Of particular interest is the need to know immediately when an Iranian fighter prepares for take-off. Two alternatives [redacted] AWACS link are:

- a. Use of Coronet Solo with a data link to AWACS.
- b. Use of data link from [redacted] AWACS in place of secure voice radio.

Preliminary study of these alternatives indicated that neither provided significant gains over the existing system.

RECOMMENDATIONS: (TS-CW) That further study of the [redacted] AWACS link be conducted. [redacted]

[redacted] It may be possible to improve upon this [redacted] and/or data-link circuits instead of secure voice.

OTHER RELATED ITEMS:

J2 PERSONNEL INVOLVED: Major [redacted] (USA),
 ODCSOPS, DA
 Major [redacted] (USAF), AFINER

POINTS OF CONTACT:

ATTACHMENTS:

- 1. Sketch of AWACS configuration

G

~~CONFIDENTIAL~~

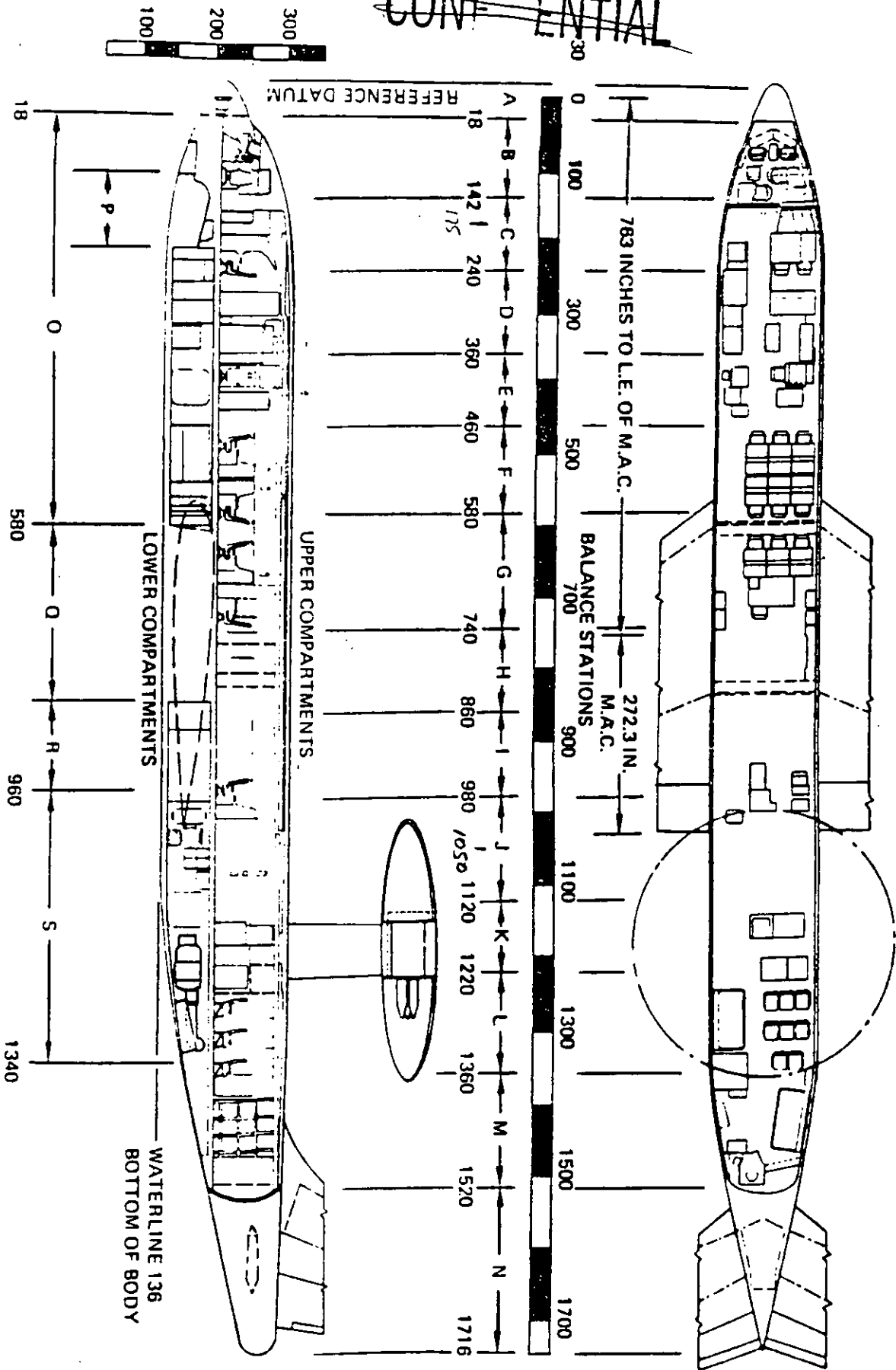

~~CONFIDENTIAL~~

AIRPLANE COMPARTMENT DIAGRAM

~~CONFIDENTIAL~~

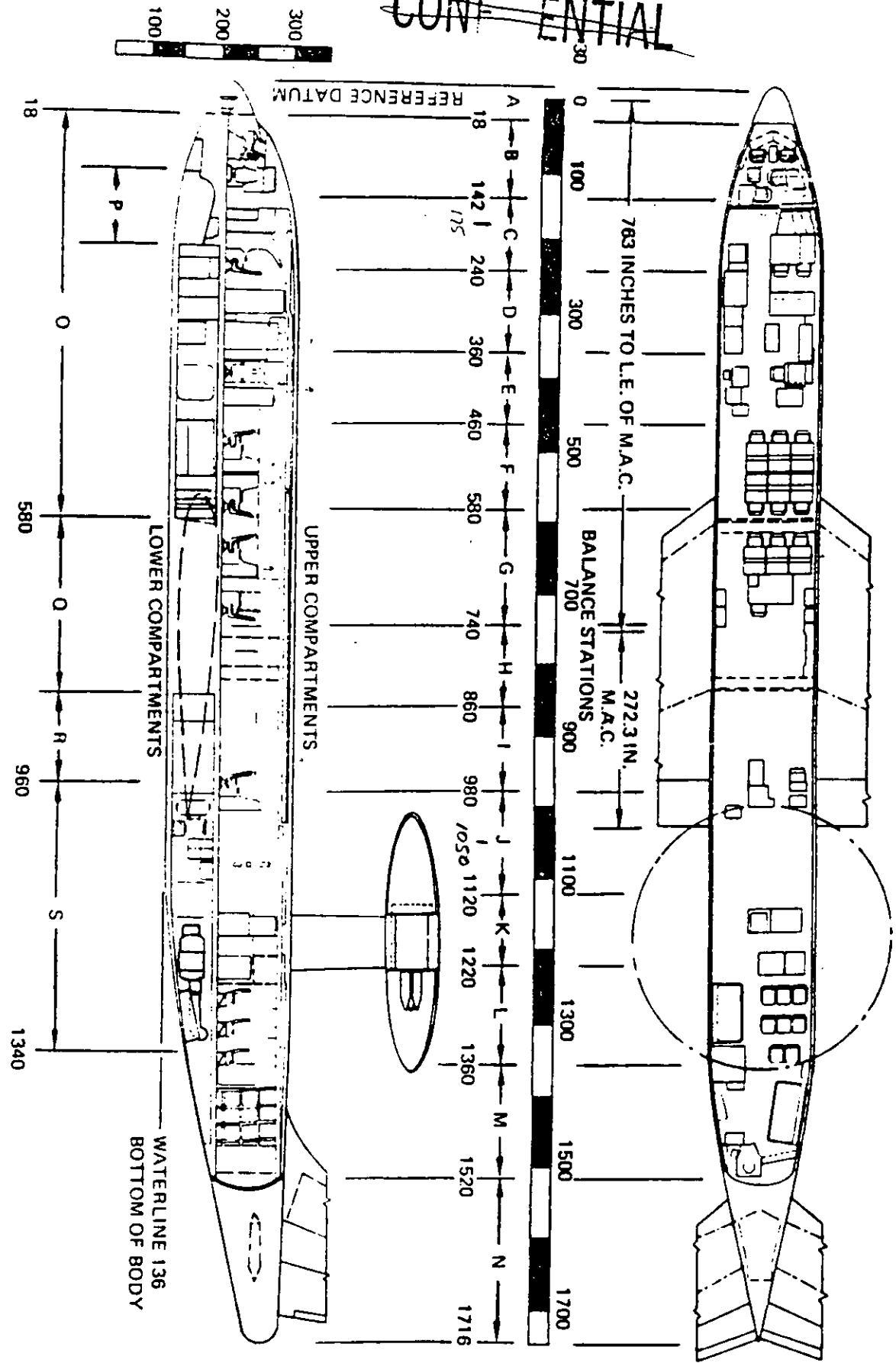

~~CONFIDENTIAL~~

~~CONFIDENTIAL~~
~~TOP SECRET~~

THE JOINT CHIEFS OF STAFF
WASHINGTON D C 20301

J-81



THE JOINT STAFF

7 October 1980

MEMORANDUM FOR MAJOR GENERAL VAUGHT
MAJOR GENERAL SECORD

Subject: Operation TINHORN (~~TS~~)(U)

At Attachment 1 is a draft concept of operations for Operation TINHORN (~~TS~~)(U) a clandestine low-level penetration of Iranian airspace for the purpose of evaluating LZ SUSAN. The concept provides for consideration and review of aircraft sources and launch bases. Annexes to the concept provide OpSec considerations and proposed mission profile information. Possible one-nite, two-nite, and multi-nite concepts are provided for your consideration. We can be prepared to brief these concepts to the OpsDepts on 14 October and exercise that night.

G

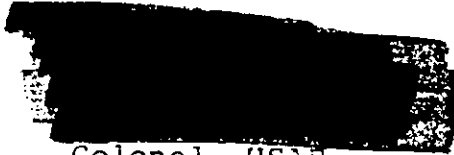

Colonel, USAF

*Classified by DDO NMCC
4 Aug 91
Declassify on: OADR
Migrated to CSNIF
by DDO NMCC 4 Aug 91*

~~TOP SECRET~~

~~CONFIDENTIAL~~

~~CONFIDENTIAL~~
~~TOP SECRET~~

POINT PAPER
on
Iran Recce Mission

PURPOSE: Evaluate LZ SUSAN as possible FOB for a rescue mission.

CONSIDERATIONS:

- Intelligence claims to have positively located the hostages in the Embassy and Ministry of Foreign Affairs (MFA).
- In view of the ongoing war and since the hostages appear to be in only two locations, our plans need to be sharpened and refined.
- We must now channel our training and equipment preparation for the best option and rehearse.
- SUSAN is uniquely valuable because it allows for rapid forward deployment of strong assault force with surprise, reduced risk, and allows operation to be executed in one night.
 - Compared to all other options, it allows mission execution with alert and rested crews
 - If SUSAN not suitable we must drop it from consideration.
- The risk involved is considered low
 - Iran/Iraq war distraction i.e. attention turned other way.
 - Iranian air capability is diminishing.
 - The route to be flown is over remote area.

~~EXT~~ Alternative to staging is long-range, helo assault over hazardous routes from [REDACTED]

CONCEPTS:

One-Nite Operation:

~~E~~ A single MC-130 will depart [REDACTED] at 1250Z and fly a 5+06 low level penetration to arrive over LZ SUSAN at 1756Z or 2336L. Upon arrival a two-man Combat Control Team (CCT) will be parachuted onto the LZ. The MC-130 will move to the south and loiter for approximately 30 minutes. Meanwhile, the CCT will survey and light (IR) a 3500' x 90' strip accomplishing all required penetrometer

~~TOP SECRET~~ ~~CONFIDENTIAL~~

E and obstruction checks. Once the LZ is established the CCT will signal the MC-130 for landing. The next 3+30 will involve a thorough survey of the LZ by vehicle-equipped, six-man, CCT to establish its suitability for C-141/C-5 operations. At 0330L the MC-130 will load the CCT and equipment and depart SUSAN for [REDACTED] arriving 0255Z (0655L).

E - As a contingency, should the CCT find the LZ to be totally unsuitable, the MC-130 will be called back to the LZ and recover the CCT with two, one-man Fulton pickups, then return to [REDACTED]

- A SAR recovery force of one Fulton equipped MC-130 will be positioned at Dhahran ready to respond to any emergency. Additionally, we would request an E-3A sortie be airborne during the entire operation.

Two-Nite Operation:

E - On the first nite a single MC-130 will launch from [REDACTED] at 0645Z and after one aerial refueling will penetrate the southern coast of Iran then proceed low level to arrive over LZ SUSAN at 2335L. After a para drop of four CCT and four [REDACTED] plus equipment, the aircraft will return to [REDACTED] to land at approximately 2256 (0256L) where it will be joined by a second MC-130. On the second nite, a single MC-130 will depart [REDACTED] at 1550Z (1950L) to fly a 5+06 low level to land at SUSAN at 2056Z (0126L). While on the ground, the MC-130 will be loaded with all equipment and personnel except for a remote activation lighting system which will be left behind for future operations. The MC-130 will depart SUSAN at 2120Z (0150L) to arrive back at [REDACTED] at 0305Z (0705L).

E - A SAR aircraft (MC-130) will be positioned at [REDACTED] for both nites. We would like to have E-3A coverage on both nites while aircraft are in Iranian airspace.

Alternatives:

- The two nite operation could be expanded to a multiple nite exercise. This would afford more recce time for the team and permit longer range observation of a larger area.

RECOMMENDATION:

- DOD should seek NCA approval to conduct this recce mission.



~~TOP SECRET~~

J- (82)

THE JOINT CHIEFS OF STAFF
WASHINGTON D.C. 20301

THE JOINT STAFF

14 October 1980

MEMORANDUM FOR MAJOR GENERAL VAUGHT
MAJOR GENERAL SECORD

Subject: Operation TINHORN (TS) (U)

~~TOP SECRET~~

Attached is a draft concept of operations for Operation TINHORN (TS) (U) a clandestine low-level penetration of Iranian airspace for the purpose of evaluating LZ SUSAN. The concept provides for consideration and review: aircraft sources and launch bases, command and control, emergency fighter cap, and rescue support. Annexes to the concept provide OpSec considerations and proposed mission profile information. Possible one-nite, two-nite, and multi-nite concepts are provided for your consideration. We can be prepared to brief these concepts to the OpsDepts on 15 October and exercise that night.

G

~~TOP SECRET~~

Colonel, USAF

CLASSIFICATION REVIEW CG 12355
CONDUCTED ON 4 Aug 92
DERIVATIVE CL BY DDO/MCC
 DECL DOWNGR TO Secret
REVIEW ON OADR
DERIVED FROM Multiple Omms

CLASSIFIED BY JCS, J-3, JTF 1-79
DECLASSIFY ON 14 OCTOBER 1986

~~TOP SECRET~~

~~TOP SECRET~~
Operation "TINHORN" (TS)

1. Concept of Operations: (TS) (U) On or about 20 Oct, conduct a nite clandestine low level penetration of Iranian airspace via MC-130E. The purpose is to insert a four-man combat control team (CCT) to conduct an on-site survey of landing zone (LZ) SUSAN located 17 miles southeast of the town of Semnan. This LZ would be very useful in the conduct of any future quick reaction strike designed to free the hostages. Details are provided for either a single-nite or multi-nite operation.

2. Schedule of Events: (S) (U)

8 Oct	Publish Draft OPLAN
15 Oct	Rehearse at Edwards AFB
17 Oct	Commence deployment
Approx 20 Oct	Conduct Operation

3. Items for Consideration: (TS) (S)

- A, E
- a. Source of aircraft (MC-130): [REDACTED]
Hurlburt [REDACTED]
- Only one Fulton Recovery A/C available
 - Closer to launch base ([REDACTED]) i.e. shorter reaction time - one day
 - No Fulton qualified crew based at [REDACTED]
 - [REDACTED] for deployment of A/C & crew required
 - Min 2 days to get A/C to [REDACTED]
- Hurlburt:
- Can use all Fulton capable A/C
 - Crews are Fulton qualified
 - Easier to explain deployment of A/C and crews
 - Minimum 3 days to get A/C to [REDACTED]
 - Minimum 4 days to get A/C to [REDACTED]
 - Minimum 2 days to get A/C to [REDACTED]
- E
- Aircraft not air refuelable
 - Aircrews and aircraft are Fulton qualified
 - Minimum 1 day to [REDACTED]
 - Minimum 2 days to [REDACTED]
- E

b. (7) Launch Base: [REDACTED]

E

-- If we use [REDACTED] A/C is better location

-- 1700 miles further from target than [REDACTED]
(13 mission hrs)

A, E

-- 1200 miles further from target than [REDACTED]
(9 mission hrs)

-- Better OpSec, i.e., no special [REDACTED] ed

-- Requires more tankers (2)

-- Would require double crew

[REDACTED]
-- Only one tanker required

A, E

-- Requires [REDACTED]

-- Another government would be aware of presence of
A/C and personnel

[REDACTED]
-- Closer than [REDACTED]

A, E

-- Base security better than [REDACTED]

-- Requires [REDACTED]

-- Two other governments [REDACTED] would be
aware

E

[REDACTED]
-- Requires cooperation of [REDACTED]

-- Penetration across Persian Gulf more risky

-- Would allow more time on the ground at the LZ in a
one nite operation

E

[REDACTED]
-- Closest to target

-- Tanker/blivits not required

-- Provides longest ground time

-- Good OpSec considerations

-- Risky penetration across Persian Gulf

[REDACTED]

Number of nites for operation:

- One nite:
 - Only one penetration required
 - Limited time on the ground
 - Depending on launch base require air refueling to provide adequate ground time
 - Risk to team minimized

A

-- [REDACTED] would not participate

- Two nites: -

- Requires two penetrations
- No air refueling required (if operate from [REDACTED])
- Allows more time on ground
- Can get surface picture plus observe area in daylight
- Increased risk to ground team

E

-- [REDACTED] can conduct recce of area

A

- Multi-nite (3 or more)

- More risk to team
- More flexibility for ground team operations
- Better opportunity to observe the LZ and surrounding activities (longer range recon)
- Puts more time between penetration
- Requires A/C and personnel to be deployed longer

[REDACTED]

Considerations:

A

a. One night operation:

- Insufficient time to conduct ground reconnaissance, will not participate.

~~TOP SECRET~~

- b. Two Nite Ops would permit extensive operation
 - Observe & photograph SUSAN during daylight
 - Expanded recon to include:
 - Semnan New Airfield (12 NM)
 - Route to Semnan-Tehran Hiway
 - Observe type and quantity of traffic
 - Sulfur mines
 - Evaluation of preliminary hide/cache sites
 - Daylight, ground based photography of:
 - Susan
 - Semnan New
 - Routes
 - Equipment/Personnel required
 - NVG's
 - 4-6 personnel
 - 2-3 motorcycles
 - PT-250 radio
 - MX-360 radio
 - 2-3 cameras w/long-range and wide angle lens

~~TOP SECRET~~

~~6.~~ Command and Control.

E a. Operation TINHORN (TS) will be controlled from a ground command post at [REDACTED]. An alternate command post will be established in an airborne E-3A AWACS. Primary communications will be via SATCOM with HF as backup. UHF relay through the AWACS will provide a tertiary communications link. Mandatory communications links follow:

- (1) CP TO WASHINGTON
- (2) CP TO AIRCRAFT IN FLIGHT
- (3) CP TO GROUND PARTY
- (4) CP TO BACKUP AIRCRAFT (BASE SITE)
- (5) ALTERNATE TO AIRCRAFT AND GROUND PARTY

[REDACTED] b. [REDACTED]

~~7.~~ Emergency Fighter Cap.

E Task Force 70 will provide a 15 minute deck alert F-14 force for flight cap. The force will be capable of penetration to the area of SUSAN utilizing KC-135 tanker support from [REDACTED]

~~8.~~ Search and Rescue (SAR).

E An MC-130 based search and rescue will be established at [REDACTED]. The MC-130 will be capable of reaching SUSAN in three hours and will be equipped with the Fulton Recovery System. AWACS interface will provide capability for pinpoint location of any SAR related position.

[REDACTED]

OPSEC ASSESSMENT OF ISBs FOR OPERATION TINHORN

E E	Satellite ELINT	Photo Satellite	ELINT Ships	(C) Friendly Radar (Ship ground)	Hostile Radar (ship or ground)	(C) Diplomatic	HUMINT
[REDACTED]	Yes	Unknown	Yes	Yes TF70	Yes Sovs near TF70		US presence would eventu- ally be pass- to Iran
[REDACTED]	Yes	Unknown	No	[REDACTED] & AWACS if cross [REDACTED]	No	Not for [REDACTED] Yes if ask to cross [REDACTED]	Low threat
[REDACTED]	Little	Unknown	Low	[REDACTED] & AWACS if cross [REDACTED]	No	Not unless [REDACTED]	Unknown but probable
[REDACTED]	Yes	Unknown	Low	Yes TF70 E	Yes Sovs near TF70	No although if suspic- ious [REDACTED] [REDACTED]	Very low

A, E

APPENDIX B TO ATTACHMENT 1

OPERATION TINHORN: OPSEC RECOMMENDATIONS FOR ENROUTE SUPPORT BASES

1. (U) The following is an OPSEC assessment of possible enroute support bases (ISBs) for operation TINHORN. Some, not all, of the pertinent factors are shown on Atch 1.

E

2. (S) [redacted] provides the most secure environment, however because of the long distance involved [redacted] and [redacted] are recommended as the launch bases. Because of the requirement to overfly [redacted] is not recommended for this preliminary operation.

A, E

3. (S) Recommended course of action is: Fly mission from [redacted] with MC-130 SAR capability stationed at [redacted] would be implemented as follows: Approach [redacted] and ask permission for C-130 [redacted] to be flown out of [redacted]. While this is the same [redacted] we used [redacted] the increased attention on the [redacted] [redacted]. Two MCs could deploy to [redacted] and commence missions in the area. After 2 or 3 days execute TINHORN, then remain for an additional 4 or 5 days before redeploying to home base. Besides helping with TINHORN this would be useful to future operations by [redacted]

E

4. (S) Alternatives to this would be to deploy to [redacted] from [redacted] carrying cargo for TF 70; or deploy by flying from [redacted] down the Red Sea and notionally to [redacted] in reality, [redacted]. This was performed successfully during RICEBOWL [redacted]

A, E

5. (S) [redacted] could be used to position the SAR capability. Aircraft would be positioned by using an approved MAC mission. Aircraft would RON with spare crew ready to fly SAR. If SAR is required, they could file for overwater route to [redacted]. If SAR not required, aircraft would return on [redacted]. Atch 2 depicts recommended action. [redacted]

~~CONFIDENTIAL~~

~~TOP SECRET~~

8 October 1980

MISSION PROFILE INFORMATION

LAUNCH BASE	T/O	COAST IN	LAND SUSAN	T/O SUSAN	COAST OUT	ENROUTE TIME			ENROUTE DISTANCE			REFUELING REQUIREMENTS
						TO COAST	OVERLAND	TOTAL	TO COAST	OVERLAND	TOTAL	
[REDACTED]	0645	1434	1005	2205	0136	7 + 49	3 + 31	11+20	2055	889	2944	Inbound Outbound Two Blivits
[REDACTED]	1250	1425	1756	2156	0127	1 + 35	3 + 31	5+06	369	889	1258	Outbound Two Blivits
[REDACTED]	1440	1515	1740	2140	0005	0 + 35	2 + 25	3+00	121	549	670	None
[REDACTED]	1352	1515	1740	2140	0005	1 + 23	2 + 25	3+48	324	549	873	Two Blivits
[REDACTED]	1114	1515	1740	2140	0005	4+01	2 + 25	6+26	549	1019	1568	Inbound Outbound Two Blivits

Conditions at LZ SUSAN: 20 October

Sunset: 1358Z (1828L)

Sunrise: 0240Z (0710L)

Nautical Darkness: 20/1447Z - 21/0152Z 11 + 05

~~CONFIDENTIAL~~

~~TOP SECRET~~

E

One-Nite Operation:

E (S) A single MC-130 will depart [REDACTED] at 1250Z and fly a 5+06 low level penetration to arrive over LZ SUSAN at 1756Z or 2336L. Upon arrival a four-man CCT will be parachuted onto the LZ. The MC-130 will move to the south and loiter for approximately 30 minutes. Meanwhile, the CCT will survey and light (IR) a 3500' x 90' strip accomplishing all required penetrometer and obstruction checks. Once the LZ is established the CCT will signal the MC-130 for landing. The next 3+30 will involve a thorough survey of the LZ to establish its suitability for C-141/C-5 operations. At 0330L the MC-130 will load the CCT and equipment and depart SUSAN for [REDACTED] arriving 0255Z (0655L).

E (S) As a contingency, should the CCT find the LZ to be totally unsuitable, the MC-130 will be called back to the LZ and recover the CCT with two, two-man Fulton pickups, then return to [REDACTED]

E (S) A SAR recovery force of one Fulton equipped MC-130 will be positioned at [REDACTED] ready to respond to any emergency. Additionally, we would request an E-3A sortie be airborne during the entire operation.

~~CONFIDENTIAL~~

Two-Nite Operation:

A, E

On the first nite a single MC-130 will launch from [REDACTED] at 0645Z and after one aerial refueling will penetrate the southern coast of Iran then proceed low level to arrive over LZ SUSAN at 2335L. After a para drop of four CCT and four [REDACTED] plus equipment, the aircraft will return to [REDACTED] to land at approximately 2256 where a second MC-130 has been prepositioned. On the second nite a single MC-130 will depart [REDACTED] at 1550Z (1990L) to fly a 5+06 low level to land at SUSAN at 2056Z (0126L). While on the ground, the MC-130 will be loaded with all equipment and personnel [REDACTED]. The MC-130 will depart SUSAN at 2120Z (0150L) to arrive back at [REDACTED] at 0305Z (0705L). ?

E

A SAR aircraft (MC-130) will be positioned at [REDACTED] for both nites. We would like to have E-3A coverage on both nites during the time we have aircraft within Iranian airspace.

~~CONFIDENTIAL~~

~~SECRET~~

MOONLIGHT

12 13 14 15 16 17 18 19 20 21 22 23 00 01 02 03 04 05 06 07 08 09 10 11 12

OCT

1

NOV

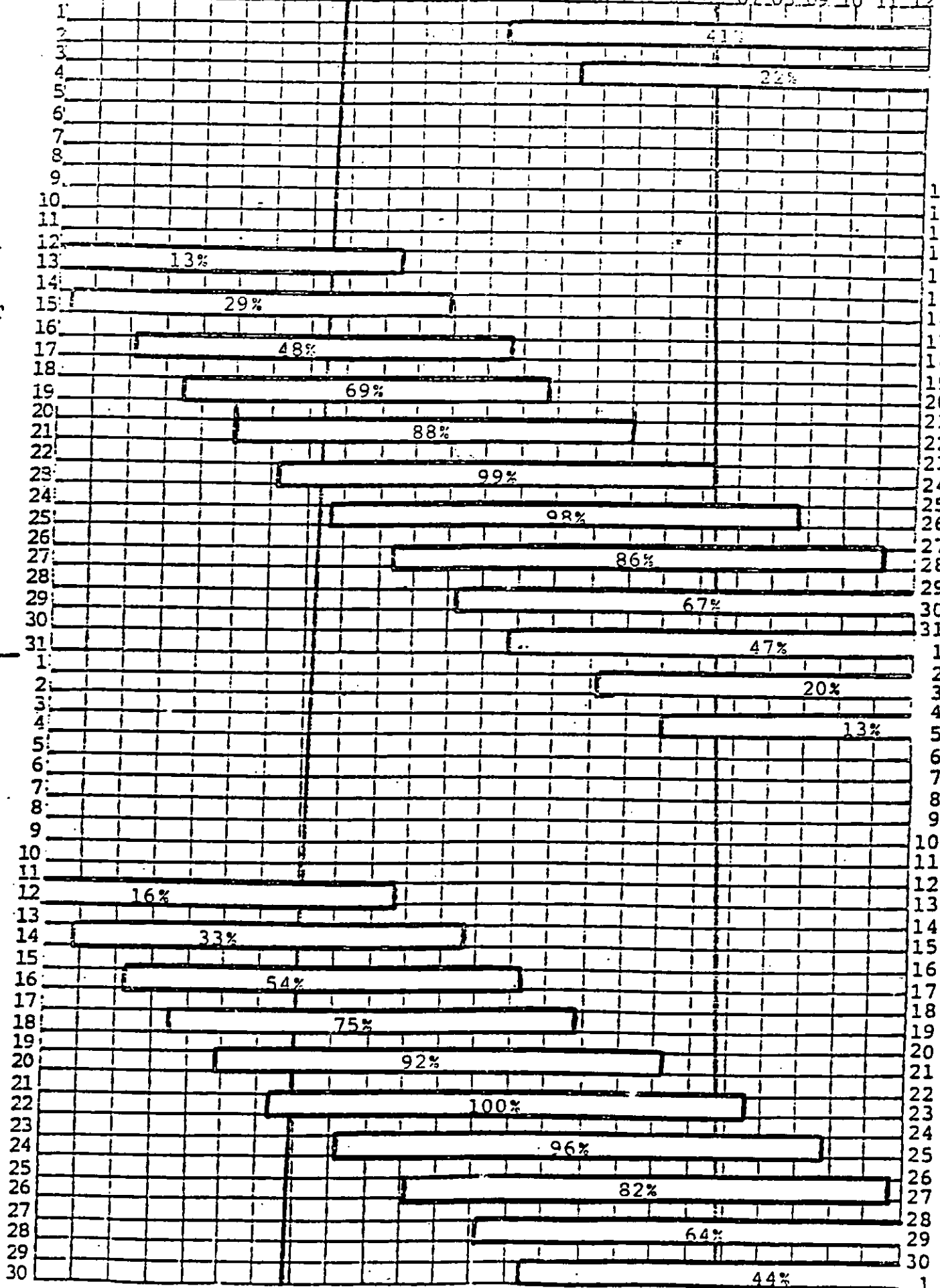

12 13 14 15 16 17 18 19 20 21 22 23 00 01 02 03 04 05 06 07 08 09 10 11 12

2
3
4
5
6
7
8
9
10
11
12
13
14
15
16
17
18
19
20
21
22
23
24
25
26
27
28
29
30
31
1
2
3
4
5
6
7
8
9
10
11
12
13
14
15
16
17
18
19
20
21
22
23
24
25
26
27
28
29
30
1

J-2

CLASSIFICATION BY 4-257-
CONDUCTED ON 3-20-80
REWRITTEN BY J. D. NMC
 DEEL DOWN TO
KEYW ON 0400
DERIVED FROM Multiple Sources

J- (84)
for History

MEMORANDUM FOR JTF STAFF AND COMPONENTS

SUBJECT: JTF Activities 4-13 May 80

Reference: JTF 2 May 80 "SNOWBIRD CONCEPT" paper.

1. The JTF Commander has directed an initial effort in accomplishing the the SNOWBIRD mission.

2. Facts:

a. There are indications [REDACTED]

b. Whereas on 24 April there was a good probability of rescue without a large number of casualties, the situation has now changed so that an increased level of Iranian alertness must be assumed. Iranian readiness may be gradually degraded as time passes but for at least the next 45 days, any rescue attempt involves an increased casualty risk.

(S) c. "Rice Bowl" proved a number of important factors.

1) A rescue operation can be planned and rehearsed without damaging security leaks.

2) Iranian airspace can be penetrated without an attendant alerting of the Iranian Armed Forces.

3) Iranian reaction to intelligence indicators is slow and weak.

4) U.S. Armed Forces personnel can be infiltrated into Iran [REDACTED] without discovery.

5) The bus incident and the change in dust conditions at Desert Track 1 points to the need for on site reception parties with secure communications.

Classified By: JCS
Declassified ON: OADR

SECRET
4 MAY 80

A

~~SECRET~~

6) The inability to obtain adequate, continuous information from Iran points to the need for an improved means of intelligence gathering.

d. To await a final, [REDACTED] before commencing operational planning will result in a substantial loss of time in the use of the JTF staff.

e. Regardless of the nature of the final form of SNOWBIRD, some actions should be taken as soon as possible, i.e., preparations and planning for ground transportation into and within Iran and a more reliable on-site intelligence system.

3. Tasks:

a. JTF to direct its initial efforts on [REDACTED] and planning a partial release concentrating initially on Tabriz.

b. J-2:

- 1) Obtain the best possible information on the location of the U.S. hostages.
- 2) Develop a concept for two separate, compartmented channels of intelligence for use of the JTF Commander.
- 3) Insure all JTF components and staff sections are supplied with adequate information.

c. J-3:

- 1) Produce a three option plan to secure the safe release of hostages from Tabriz. ~~Produce a three option concept plan to secure the safe release of hostages from Tabriz.~~ The first option will focus on the predominante use of Iranian assets, the second will utilize US Armed Forces resources to the greatest degree possible and the final option will rely on [REDACTED]

- 2) Keep an updated activities schedule of JTF units.

~~SECRET~~

~~SECRET~~

~~SECRET~~

~~SECRET~~

3) Recommend a JTF staff and unit organization to accomplish the Tabriz mission. S: 8 May.



d. J-4:

- 1) Take all necessary actions to reconstitute JTF equipment.
- 2) Establish a list of outstanding equipment needs to support the Tabriz mission.
- 3) Produce a Consolidated Mission Critical Equipment need list keyed to projected availability dates.

e. J-6:

- 1) Derive the total communications equipment and personnel requirement from the J-3 plan for Tabriz.
- 2) Contribute to the J-4 Consolidated Mission Critical Equipment need list.

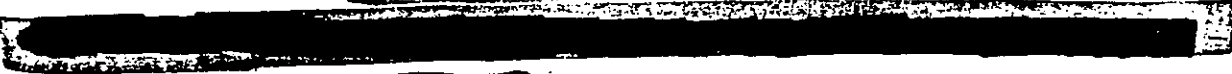
~~(c)~~ f. Special Plans:

1) Develop an overall 



2) Within 

g. Weather Officer:

- 1) Continue to provide weather information on Iran.
- 2) Produce a continuously updated weather file on the Tabriz area.
- 3) Produce a density/altitude chart for the Tabriz area for the month of June.

h. PSYOPS:

- 1) Produce a PSYOPS plan for SNOWBIRD.
- 2) Produce a PSYOPS plan for the Tabriz operation

i. JTF Units:

No modification of previous instructions from the JTF Commander.

~~SECRET~~

~~TOP SECRET~~

~~SECRET~~

WORKING PAPER

POINT PAPER

on

Follow-on Planning

- Parts of Plan Required:

- Movement to target.
- Actions at the target.
- Movement to extraction point.
- Extraction from Iran.

~~(6)~~ Problems resulting from initial attempt.

- Hostages must be precisely located.
- Soviets may offer assistance in form of early warning radar (portable).
- Security of hostages will be increased at least for near term.
- Security around the Embassy (surface access) may be increased, movement in area may be denied at night.
- New agents will have to be inserted into Teheran.
- Identification of the intent to use a landing strip in the vicinity of Teheran may preclude the use of Mahzariyeh.

-  The guards around and within the Embassy may obtain protection against CS.

- Any dependency on our Allies for support or use of their bases may be more difficult.

- ~~Covering any training~~ activities from press will be more difficult also movement forward of DELTA or support a/c.

- Item one, movement to target.

- Factors:

- Reliance on mechanical trustworthiness should be minimized.

- A repeat of previous M.O. is probably infeasible.

~~SECRET~~

~~TOP SECRET~~

C

[REDACTED]

- This portion of the plan should be as uncomplicated as possible.
- Must maintain the ability ^{to} extract or abort for as far into the plan as possible.

A

- This portion of plan should have least affect on flexibility of DELTA's execution phase as possible.
- Redundancy and/or built in alternatives are desirable.

(S)

Possible solutions:

A

- Move DELTA to target area via [REDACTED]

- Move by surface ship/boat to Iran coast, then by surface vehicle to target.

A

- Move by military airlift (C-5) to Manzariyeh, then by surface vehicle or smaller helo (BLACKHAWK) to target.

A

- Use US, [REDACTED] Manzariyeh.

- Bring smaller helos in MC-130s or C-130s led by MCs to Manzariyeh or more northern desert strip.

- [REDACTED] insertion of DELTA in vicinity of Teheran, move by surface vehicle or smaller helo to target.

A, E

- [REDACTED] DELTA [REDACTED] in specially designed [REDACTED]

- Fly DELTA into Teheran on [REDACTED]

[REDACTED]

Item two, action at the target:

- Factors:
 - To be worked out by DELTA.

A

- Possible solutions:
 - To be worked out by DELTA.

~~SECRET~~

~~TOP SECRET~~

- Item three, movement to extraction point

~~(S)~~ Factors:

- Helo extraction may be made impossible by weather and defensive activities--in any case a solid alternate method should be developed.
- The location of the extraction point should have alternatives e.g., Manzariyeh and Mehrabad.
- Additional protection of the extraction movement and point should be developed.
- Deception may play in our favor more so now as Iranians will probably tend to overreact to any suspect activity.
- Any surface extraction route should be preplanned, protected (roll-up force & AC-130) and practiced (day & nite) eventually in Tehran.
- We should program alternate sources of extraction vehicles.

A

- Possible Solutions:

- Establish a dual movement plan that includes both light helos and surface vehicles.
 - Provides redundancy.
 - Helos can provide protection along extraction route.
- Use surface vehicles with AC-130 overhead for protection.
- Use light helo (Blackhawk) which would be carried to forward staging base in C-5/C-141.

A ~~(S)~~ Use [redacted] or other military vehicles acquired from the motorpool.

A ~~(S)~~ Fly our own [redacted]

NEW

A E ~~(S)~~ [redacted] in from [redacted] (specially designed) and preposition.

~~SECRET~~

~~TOP SECRET~~

~~TOP SECRET~~

- Item four, extraction from Iran

- Factors:

- Because we can expect an increased alert/reaction status, consideration will have to be given to suppressing the air defense capability.

E (X) - May wish to consider alternate extraction bases, i.e., if we come out south, we go to [redacted] If everything is OK as we pass [redacted] air-refuel and proceed to [redacted] [redacted] Same procedure could be worked going out over [redacted]

- The use of CAP to protect our extraction would probably be required.

- This part of the plan should have built in redundancy.

- We may have to carry in more medical capability aboard the extraction aircraft as use of nearby friendly countries may not be possible.

- Possible solutions:

- Bring a [redacted]

- Program [redacted]

- Bring in an [redacted]

- Perform a [redacted]

SNOW BIRD CONCEPT

- Mission: Secure the safe release of the US hostages held in Iran.
- Assumptions:
 - Exact hostage location confirmable continuously.
 - At least two independent, in-country compartmented safehouse facilities can be aquired.
 - A C-141 capable airfield w/in 100 NM from or 15 min driving time from hostage sites can be identified for use.
 - No significant increase in Iranian intelligence capability.
 - No significant increase in armed force's readiness will occur until after Hostage release.
- Priority of effort:
 - Locate the hostages precisely - [REDACTED]

[REDACTED]

[REDACTED]

- E - Consider surface and air insertion from [REDACTED] JTF
- Use UH-60s, Pave Low or any other facilitating A/C - JTF

Plan Characteristics:

- A - Ground plan developed by [REDACTED] rehearsed and adjusted to accommodate Hostage location and custodial threat.
- Each Phase complemented by a redundant plan that is connected to previous and subsequent phases.
- A - An equally meritorious [REDACTED]

SNOW BIRD PHASES

1. Planning
2. Training
3. Deployment
4. Insertion

2 May 80

- 5. Hostage release
- 6. Extraction
- 7. Recovery
- 8. Isolation/Debriefing

~~(X)~~ Issues affirmed and lessons learned from first attempt.

- Hostages must be precisely located and [REDACTED]
- Security of hostages will be increased at least for near term.
- Security around the Embassy (surface access) may be increased, movement in area may be denied at night for a while.
- The guards around and within the Embassy may obtain protection against CS.
- Any dependency on our Allies for support or use of their bases may be more difficult to arrange (except [REDACTED])
- [REDACTED] will be more difficult also movement forward of DELTA and support A/C.
- Identification of our previous intent to use a landing strip in the vicinity of Tehran may preclude the use of Manzariyeh.
- [REDACTED]
- New agents with [REDACTED] will have to be inserted into Tehran.
- Soviets may offer assistance in form of early warning radar (portable).
- A better CEOI - Key locations and compartmented command and control plan - all levels.
- Considerations for Phase Four, movement to target.

~~(A)~~ - Factors:

- This portion of the plan should be as uncomplicated as possible.
- This portion of plan should have least effect on flexibility of DELTA's execution phase as possible.

- Must maintain the ability to extract or abort for as far into plan as possible.
- Reliance on mechanical trustworthiness should be minimized and all components checked by more than one system of validation (Navy Helicopter Maintenance, JTF Commander did not visit ship).
- A repeat of previous M.O. is probably infeasible. (May be useful as deception)
- Intel will have to track the continued availability of our vehicles.
- Redundancy and/or build in alternatives are desirable.

(S) - Operational concepts under examination.

A

- Move DELTA to target area via [REDACTED]. (One nite)
- Move sizeable advanced party (8-12) by surface ship/boat to Iran coast, then by surface vehicle to target. Slow, certain and varifiable.
- Move by military airlift (C-5) to Manzarīyeh, then by surface vehicle or smaller helo (BLACKHAWK) to target. (one nite)

A

- Use US, [REDACTED]
- Bring smaller helos in MC-130s or C-130s led by MCs to [REDACTED] or more northern desert strip. (One nite or one nite +)
- Parachute insertion of DELTA in vicinity of Tehran, move by surface vehicle or smaller helo to target. (One nite or one nite +)

E

- Truck [REDACTED] in from [REDACTED] in specially designed vehicles.
- Fly DELTA [REDACTED]

A

- Obtain friendly Iranian assistance from within Iran to arrange vehicular movement of [REDACTED] to safehouse and/or target areas.
- Railroad from [REDACTED]
- Selected combination of above and others yet to be checked.

2. (rscw) Under SNOWBIRD planning, [redacted] intelligence data would be transmitted from CONUS by secure voice radio to J2 personnel aboard AWACS. Some individuals feel that this is a cumbersome and slow means of relaying critical intelligence material [redacted]. Of particular interest is the need to know immediately when an Iranian fighter prepares for take-off. Two alternatives [redacted] AWACS link are:

- a. Use of Coronet Solo with a data link to AWACS.
- b. Use of data link from [redacted] AWACS in place of secure voice radio.

Preliminary study of these alternatives indicated that neither provided significant gains over the existing system.

RECOMMENDATIONS: (TS-CW) That further study of the [redacted] AWACS link be conducted. [redacted]

[redacted] It may be possible to improve upon this [redacted] and/or data-link circuits instead of secure voice.

OTHER RELATED ITEMS:

J2 PERSONNEL INVOLVED: Major [redacted] (USA),
 ODCSOPS, DA
 Major [redacted] (USAF), AFINER

POINTS OF CONTACT:

ATTACHMENTS:

- 1. Sketch of AWACS configuration

G

AIRPLANE COMPARTMENT DIAGRAM

~~CONFIDENTIAL~~

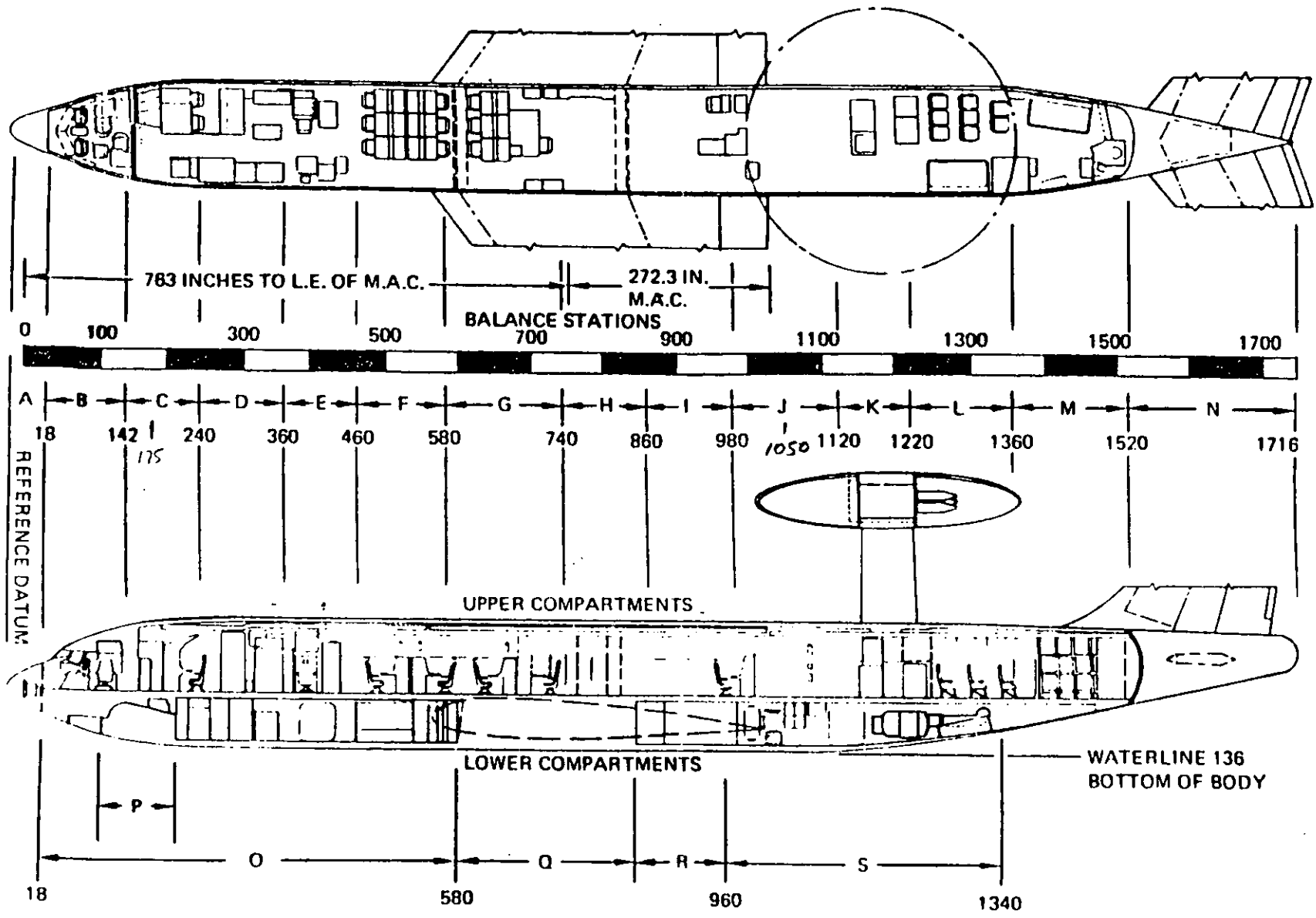

~~CONFIDENTIAL~~

AIRPLANE COMPARTMENT DIAGRAM

~~CONFIDENTIAL~~

~~CONFIDENTIAL~~

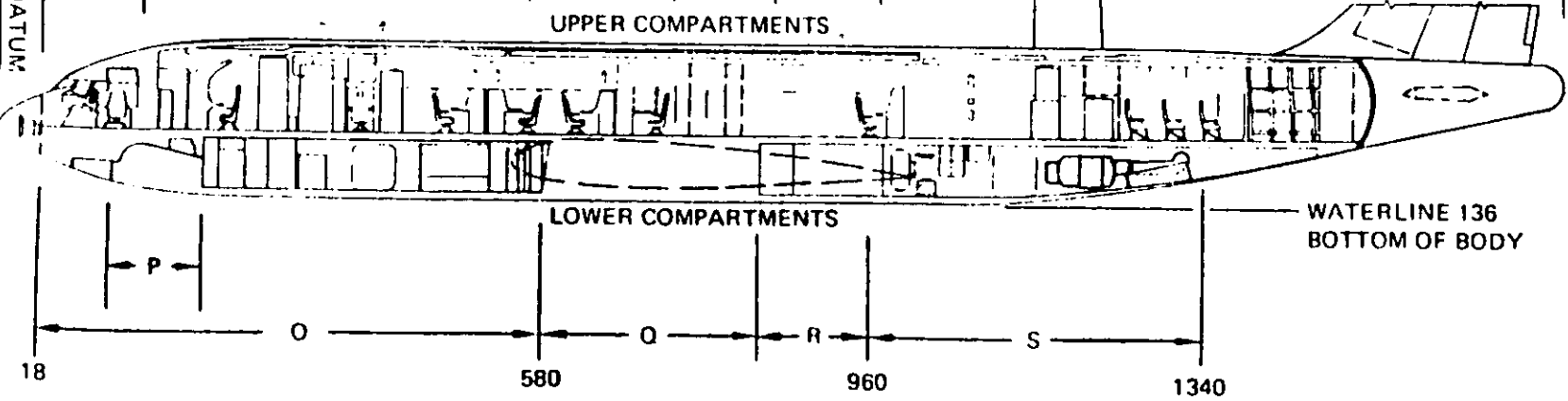
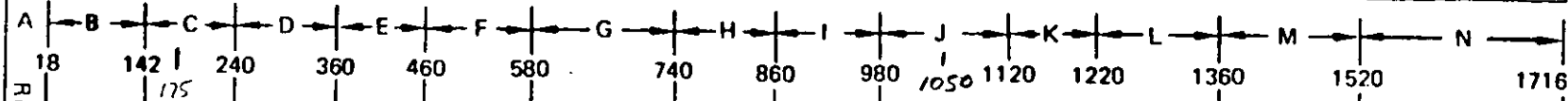
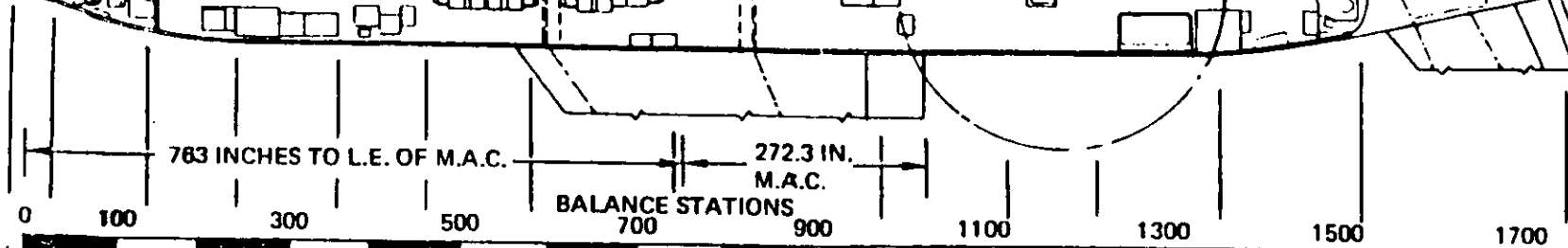
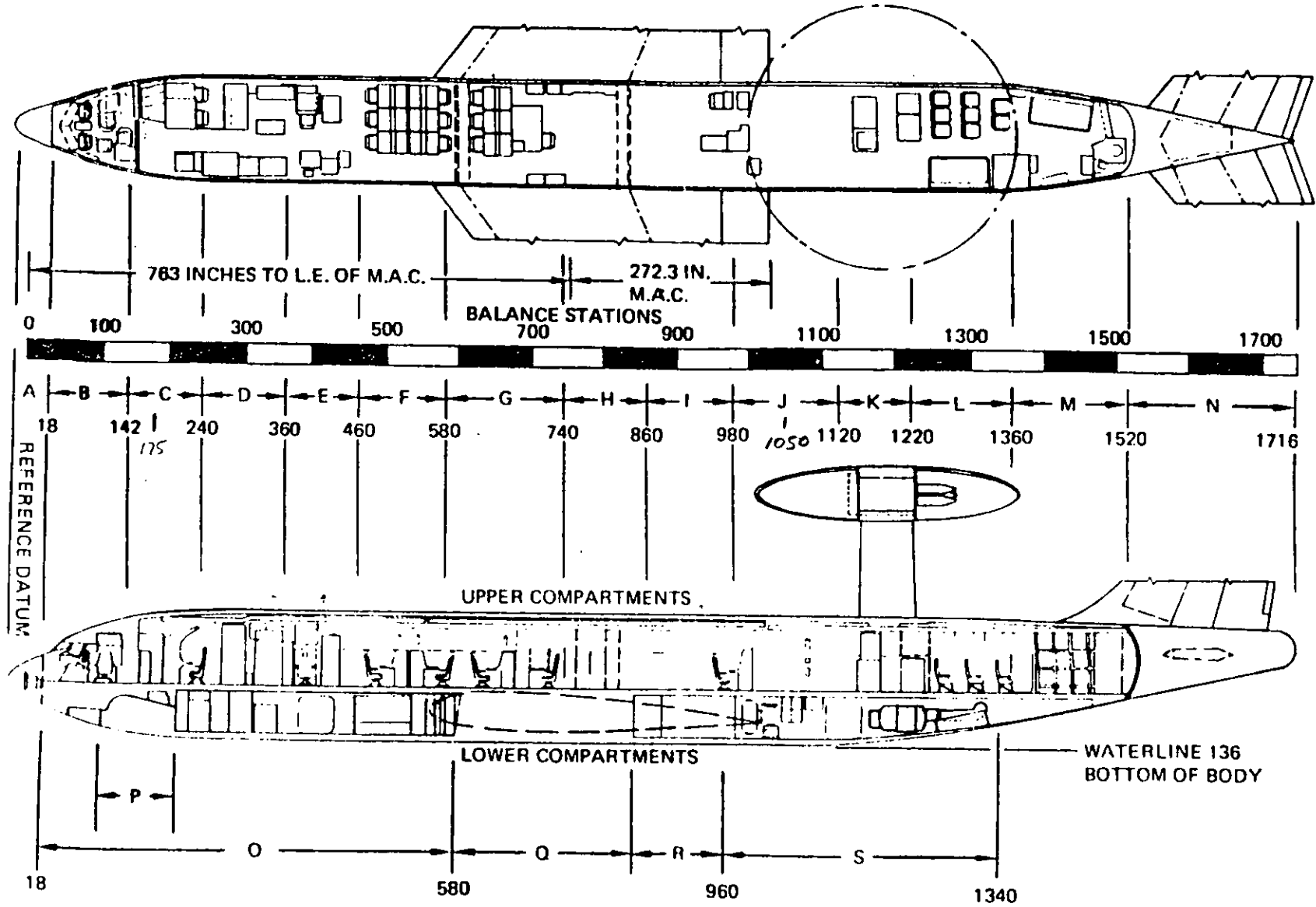



~~CONFIDENTIAL~~
~~TOP SECRET~~

THE JOINT CHIEFS OF STAFF
WASHINGTON D C 20301

J-81

THE JOINT STAFF

7 October 1980

MEMORANDUM FOR MAJOR GENERAL VAUGHT
MAJOR GENERAL SECORD

Subject: Operation TINHORN (~~TS~~)(U)

At Attachment 1 is a draft concept of operations for Operation TINHORN (~~TS~~)(U) a clandestine low-level penetration of Iranian airspace for the purpose of evaluating LZ SUSAN. The concept provides for consideration and review of aircraft sources and launch bases. Annexes to the concept provide OpSec considerations and proposed mission profile information. Possible one-nite, two-nite, and multi-nite concepts are provided for your consideration. We can be prepared to brief these concepts to the OpsDepts on 14 October and exercise that night.

G

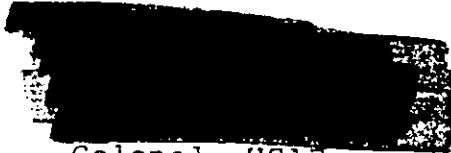

Colonel, USAF

*Classified by DDO NMCC
4 Aug 91
Declassify on: OADR
Migrated to CSNIF
by DDO NMCC 4 Aug 91*

~~TOP SECRET~~

~~CONFIDENTIAL~~

~~CONFIDENTIAL~~
~~TOP SECRET~~

POINT PAPER
on
Iran Recce Mission

PURPOSE: Evaluate LZ SUSAN as possible FOB for a rescue mission.

CONSIDERATIONS:

- Intelligence claims to have positively located the hostages in the Embassy and Ministry of Foreign Affairs (MFA).
- In view of the ongoing war and since the hostages appear to be in only two locations, our plans need to be sharpened and refined.
- We must now channel our training and equipment preparation for the best option and rehearse.
- SUSAN is uniquely valuable because it allows for rapid forward deployment of strong assault force with surprise, reduced risk, and allows operation to be executed in one night.
 - Compared to all other options, it allows mission execution with alert and rested crews
 - If SUSAN not suitable we must drop it from consideration.
- The risk involved is considered low
 - Iran/Iraq war distraction i.e. attention turned other way.
 - Iranian air capability is diminishing.
 - The route to be flown is over remote area.

~~ECF~~ Alternative to staging is long-range, helo assault over hazardous routes from [REDACTED]

CONCEPTS:

One-Nite Operation:

~~E~~ A single MC-130 will depart [REDACTED] at 1250Z and fly a 5+06 low level penetration to arrive over LZ SUSAN at 1756Z or 2336L. Upon arrival a two-man Combat Control Team (CCT) will be parachuted onto the LZ. The MC-130 will move to the south and loiter for approximately 30 minutes. Meanwhile, the CCT will survey and light (IR) a 3500' x 90' strip accomplishing all required penetrometer

~~TOP SECRET~~ ~~CONFIDENTIAL~~

E and obstruction checks. Once the LZ is established the CCT will signal the MC-130 for landing. The next 3+30 will involve a thorough survey of the LZ by vehicle-equipped, six-man, CCT to establish its suitability for C-141/C-5 operations. At 0330L the MC-130 will load the CCT and equipment and depart SUSAN for [REDACTED] arriving 0255Z (0655L).

E - As a contingency, should the CCT find the LZ to be totally unsuitable, the MC-130 will be called back to the LZ and recover the CCT with two, one-man Fulton pickups, then return to [REDACTED]

- A SAR recovery force of one Fulton equipped MC-130 will be positioned at Dhahran ready to respond to any emergency. Additionally, we would request an E-3A sortie be airborne during the entire operation.

Two-Nite Operation:

E - On the first nite a single MC-130 will launch from [REDACTED] at 0645Z and after one aerial refueling will penetrate the southern coast of Iran then proceed low level to arrive over LZ SUSAN at 2335L. After a para drop of four CCT and four [REDACTED] plus equipment, the aircraft will return to [REDACTED] to land at approximately 2256 (0256L) where it will be joined by a second MC-130. On the second nite, a single MC-130 will depart [REDACTED] at 1550Z (1950L) to fly a 5+06 low level to land at SUSAN at 2056Z (0126L). While on the ground, the MC-130 will be loaded with all equipment and personnel except for a remote activation lighting system which will be left behind for future operations. The MC-130 will depart SUSAN at 2120Z (0150L) to arrive back at [REDACTED] at 0305Z (0705L).

E - A SAR aircraft (MC-130) will be positioned at [REDACTED] for both nites. We would like to have E-3A coverage on both nites while aircraft are in Iranian airspace.

Alternatives:

- The two nite operation could be expanded to a multiple nite exercise. This would afford more recce time for the team and permit longer range observation of a larger area.

RECOMMENDATION:

- DOD should seek NCA approval to conduct this recce mission.



~~TOP SECRET~~

J-82

THE JOINT CHIEFS OF STAFF
WASHINGTON D.C. 20301

THE JOINT STAFF

14 October 1980

MEMORANDUM FOR MAJOR GENERAL VAUGHT
MAJOR GENERAL SECORD

Subject: Operation TINHORN (TS) (U)



Attached is a draft concept of operations for Operation TINHORN (TS) (U) a clandestine low-level penetration of Iranian airspace for the purpose of evaluating LZ SUSAN. The concept provides for consideration and review: aircraft sources and launch bases, command and control, emergency fighter cap, and rescue support. Annexes to the concept provide OpSec considerations and proposed mission profile information. Possible one-nite, two-nite, and multi-nite concepts are provided for your consideration. We can be prepared to brief these concepts to the OpsDepts on 15 October and exercise that night.

G

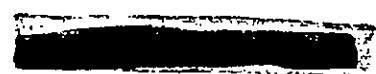

Colonel, USAF

CLASSIFICATION REVIEW CG 12355
CONDUCTED ON 4 Aug 92
DERIVATIVE CL BY DDO/MCC
 DECL DOWNGR TO Secret
REVIEW ON OADR
DERIVED FROM Multiple Omms

CLASSIFIED BY JCS, J-3, JTF 1-79
DECLASSIFY ON 14 OCTOBER 1986

~~TOP SECRET~~

~~TOP SECRET~~
Operation "TINHORN" (TS)

1. Concept of Operations: (TS) (U) On or about 20 Oct, conduct a nite clandestine low level penetration of Iranian airspace via MC-130E. The purpose is to insert a four-man combat control team (CCT) to conduct an on-site survey of landing zone (LZ) SUSAN located 17 miles southeast of the town of Semnan. This LZ would be very useful in the conduct of any future quick reaction strike designed to free the hostages. Details are provided for either a single-nite or multi-nite operation.

2. Schedule of Events: (S) (U)

8 Oct	Publish Draft OPLAN
15 Oct	Rehearse at Edwards AFB
17 Oct	Commence deployment
Approx 20 Oct	Conduct Operation

3. Items for Consideration: (TS) (S)

- A, E
- a. Source of aircraft (MC-130): [REDACTED]
Hurlburt [REDACTED]
- Only one Fulton Recovery A/C available
 - Closer to launch base ([REDACTED]) i.e. shorter reaction time - one day
 - No Fulton qualified crew based at [REDACTED]
 - [REDACTED] for deployment of A/C & crew required
 - Min 2 days to get A/C to [REDACTED]
- Hurlburt:
- Can use all Fulton capable A/C
 - Crews are Fulton qualified
 - Easier to explain deployment of A/C and crews
 - Minimum 3 days to get A/C to [REDACTED]
 - Minimum 4 days to get A/C to [REDACTED]
 - Minimum 2 days to get A/C to [REDACTED]
- E
- Aircraft not air refuelable
 - Aircrews and aircraft are Fulton qualified
 - Minimum 1 day to [REDACTED]
 - Minimum 2 days to [REDACTED]
- E

b. (7) Launch Base: [REDACTED]

E

-- If we use [REDACTED] A/C is better location

-- 1700 miles further from target than [REDACTED]
(13 mission hrs)

A, E

-- 1200 miles further from target than [REDACTED]
(9 mission hrs)

-- Better OpSec, i.e., no special [REDACTED] ed

-- Requires more tankers (2)

-- Would require double crew

[REDACTED]

-- Only one tanker required

A, E

-- Requires [REDACTED]

-- Another government would be aware of presence of
A/C and personnel

[REDACTED]

-- Closer than [REDACTED]

A, E

-- Base security better than [REDACTED]

-- Requires [REDACTED]

-- Two other governments [REDACTED] would be
aware

[REDACTED]

E

-- Requires cooperation of [REDACTED]

-- Penetration across Persian Gulf more risky

-- Would allow more time on the ground at the LZ in a
one nite operation

E

[REDACTED]

-- Closest to target

-- Tanker/blivits not required

-- Provides longest ground time

-- Good OpSec considerations

-- Risky penetration across Persian Gulf

- Phase Five, action at the target:

~~(S)~~ - Factors:

- To be worked out by DELTA.

~~(S)~~ - Possible solutions:

- To be worked out by DELTA.

- Phase Six, movement to extraction point

- Factors:

- The location of the extraction point(s) should have alternatives e.g., Manzariyeh and Mehrabad, others.

- Additional protection/security of the extraction movement and extraction point should be developed.

- Any surface extraction route should be preplanned, protected (roll-up force and AC-130) and practiced (day & nite) eventually in Tehran.

- Helo extraction may be made impossible by weather and defensive activities--in any case a solid alternatives methods should be developed.

- We should program alternate sources of extraction vehicles i.e. motorpool, buy ahead of time.

- Deception may play in our favor more so now as Iranians will probably tend to overreact to a variety of suspect activity.

- Possible with helicopters from Indian Ocean.

~~(S)~~ - Possible solutions:

- Establish a dual movement plan that includes both light helos and surface vehicles.

- Provides redundancy.

- Helos can provide protection along extraction route.

- Use surface vehicles with AC-130 overhead for protection.

- Use light helo (Blackhawk) which would be carried to forward staging base in C-5/C-141.

A

~~(S)~~ Use [redacted] or other military vehicles acquired from motorpool. (Use Iranian agents to locate and check)

(C) Fly our own extraction vehicles into Semnan - Manzariyeh - others.

A, E

- Drive extraction vehicles in from [redacted] (specially designed) and preposition. Use [redacted]

- Phase Seven, extraction from Iran

- Factors:

- This part of the plan should have built in redundancy,

- Because we can expect an increased alert/reaction status, consideration will have to be given to suppressing or frustrating the air-defense capability.

- The use of CAP to protect our extraction would probably be required.

E (C)

- May wish to consider alternate extraction landing bases, i.e., if we come out south, we go to [redacted] If everything is OK as we pass [redacted] air-refuel and proceed to [redacted] Same procedure could be worked going out over [redacted]

- We may have to carry in more medical capability aboard the extraction aircraft as use of nearby friendly countries may not be possible.

- Re-evaluate use of Iraq

(C) - Possible solutions:

A

- Bring MC-130s to Mehrabad, Manzariyeh, Semnan New or other remote base in vicinity of hostage holding point, stand by for extraction.

- Could put MC-130s at more than one location.

- Bring a [redacted] Mehrabad, Manzariyeh or Semnan New,

- Program [redacted] Mehrabad, Manzariyeh, Semnan New or another airfield.

A

- Perform a [redacted] Mehrabad,

- Bring in an [redacted] Mehrabad.

- Risky

Point Paper
on
Allied Assistance

- Previously we could not afford to solicit assistance from select Middle East friendly countries for OPSEC reasons.

~~(S)~~ We may be able to work thru [redacted] with low risk of discovery.

-- If rejected we are not hurt

-- If our intent to use a forward [redacted] base is blown

--- The operation is not injured

--- Will draw Iranian attention [redacted]

-- If our request is accepted and we determine that OPSEC is maintained

--- We can move our extraction aircraft (MC-130/C-141) forward to a point that aerial refueling is not required.

--- AC-130s can be moved forward

--- Tanker support for fighter cap can forward base

--- Might be able to establish a forward based fighter alert

~~(S)~~ --- We have a fall back operating location if [redacted] operation blown

~~(S)~~ By working a two-pronged approach [redacted] we maintain the option to come from either or both directions.

5-(85)

~~SECRET~~

~~TOP SECRET~~

OPERATION SNOWBIRD

MISSION: 26 APRIL

NOT POSSIBLE AT THIS TIME:

LACK OF INTELLIGENCE

LACK OF FORCE PROFICIENCY

LACK OF STAGING BASES

[REDACTED]

~~TOP SECRET~~

~~SECRET~~

CLASSIFICATION REVIEW EO 12356
CONDUCTED ON 4 Aug 92
DERIVATIVE CL BY DDO & me
 DECL DOWN TO Secret
REV ON OADR
DOWNGRADED FROM Multiple Sources

Classified By: JES
Declassified ON: OADR

TRAINING CONCEPT (CONT'D)

~~A~~ ~~15~~ KEY DATES
15 JULY

~~A~~

JOINT TRAINEX
SIMULTANEOUS AIRFIELD SEIZURE

~~A~~ ~~20~~ 20 JULY
OPTION 9 CONCEPT EVALUATION
AIRFIELD SEIZURE

~~A~~

21 JULY
REDEPLOYMENT

26 JULY - 11 AUGUST
MAINTENANCE/LEAVE
ANALYSIS/SURVEY TEAM

11 - 20 AUGUST
COMPONENT TRAINING

SNOWBIRD INTELLIGENCE

ASSETS:

~~SECRET~~
~~TOP SECRET~~

HUMINT ASSETS

~~SECRET~~

IMINT ASSETS

ACTIONS:

~~SECRET~~ PRODDED TWICE
TECH INTEL:

SR 71

~~SECRET~~
~~TOP SECRET~~

~~SECRET~~ DOD HUMINT ASSETS IN PROCESS

SUMMARY:

SOME RELEASE

TRIALS POSSIBLE

BREAKTHROUGH: LATE JULY

~~SECRET~~

~~SECRET~~

OPTIONS

SNOWBIRD

~~(S)~~ LAUNCH BASE

ASSETS REQUIRED

I [REDACTED] PAVE LOW M/A/HC-130 F-14 C-141B (STRETCH)

II [REDACTED] PAVE LOW M/A/HC-130 F-14

III [REDACTED] PAVE LOW M/A/HC-130 F-14

IV [REDACTED] PAVE LOW M/A/HC-130 C-5

(SHORT WARNING)

V [REDACTED] OR TANKER MIL VEH C-5 C-141B (STRETCH)
(NO HELICOPTERS)

VI [REDACTED] PAVE LOW M/A/HC-130 CH-47 F-14

VII [REDACTED] PERSIAN GULF PAVE LOW [REDACTED]

VIII GULF OF OMAN ~~(S)~~ LPH [REDACTED] PAVE LOW
UH-60 M/A/HC-130

IX [REDACTED] OH-6 M/A/HC-130 C-141B (STRETCH)

~~TOP SECRET~~

~~SECRET~~

E

A

~~TOP SECRET~~

SNOWBIRD FORCE SELECTION

PREVIOUS:

~~A~~
~~(S)~~

DELTA

RANGERS: NOW ENTIRE BATTALION

SOW 130 FLEET MC, AC, HC, EC

MAC 141s

NEW:

PAVE LOW

UH-60

CH-47

~~██████████~~

TRUCKS

A

~~TOP SECRET~~

~~CONFIDENTIAL~~

A

~~TOP SECRET~~
SNOWBIRD [REDACTED]

OPSEC DIFFICULTIES:

- MORE, LARGER FORCES
- PREVIOUS IDENTIFICATION
- END OF YEAR FUNDING

A

[REDACTED]
[REDACTED]
[REDACTED]

TRAINING CONCEPT
10 JUNE - 3 SEPTEMBER

GENERAL CONCEPT

TRAIN THE PARTS, THAN THE WHOLE
EXERCISE THE MOST COMPLEX SCENARIO
ADJUST TO INTEL INPUT

KEY DATES

10 JUNE

101ST DEPLOYMENT TO NORTON AFB

5 JULY

FORCE DEPLOYMENT

DUGWAY

ORO GRANDE

7 JULY

INTEGRATED HELO OPS

TRAINING CONCEPT (CONT'D)

KEY DATES

20 - 23 AUGUST

DEPLOYMENT

25 AUGUST - 3 SEPTEMBER

JOINT TRAINING

~~CONFIDENTIAL~~

~~TOP SECRET~~

~~CONF~~

SNOWBIRD LAUNCH BASES

E

①

[REDACTED]

USEFUL, 72 HR STANDBY

[REDACTED]

USEFUL, BUT....

[REDACTED]

SURVEY

[REDACTED]

~~TOP SECRET~~

~~CONFIDENTIAL~~

~~SECRET~~
~~TOP SECRET~~

CONCLUSIONS:

INTELLIGENCE BREAKTHROUGH: LATE AUGUST?

STAGING BASES

C/P  PROGRESS ESSENTIAL

CAPTURE EXPERIENCE FOR FUTURE USE

FORCE READINESS: 3 WEEKS AFTER HARD INTELLIGENCE

~~TOP SECRET~~

~~SECRET~~

TOP SECRET
★ DOUBLESTAR

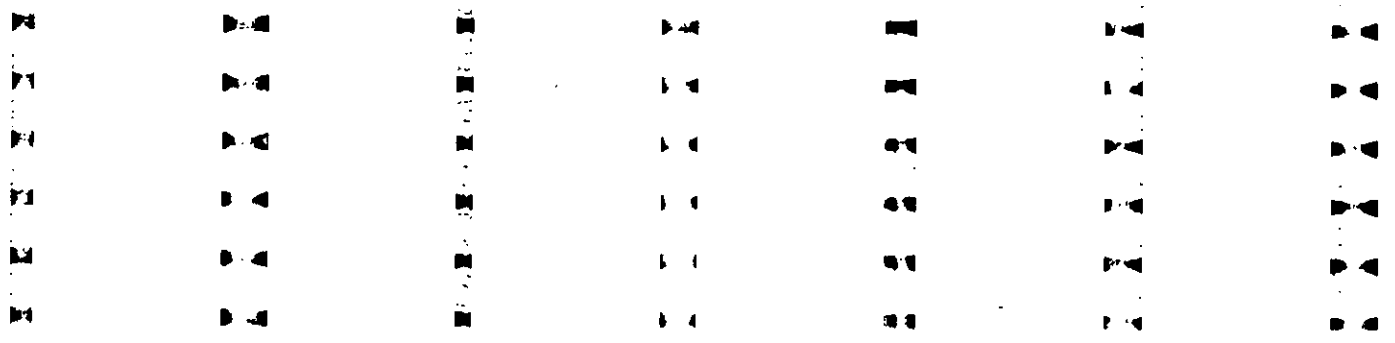
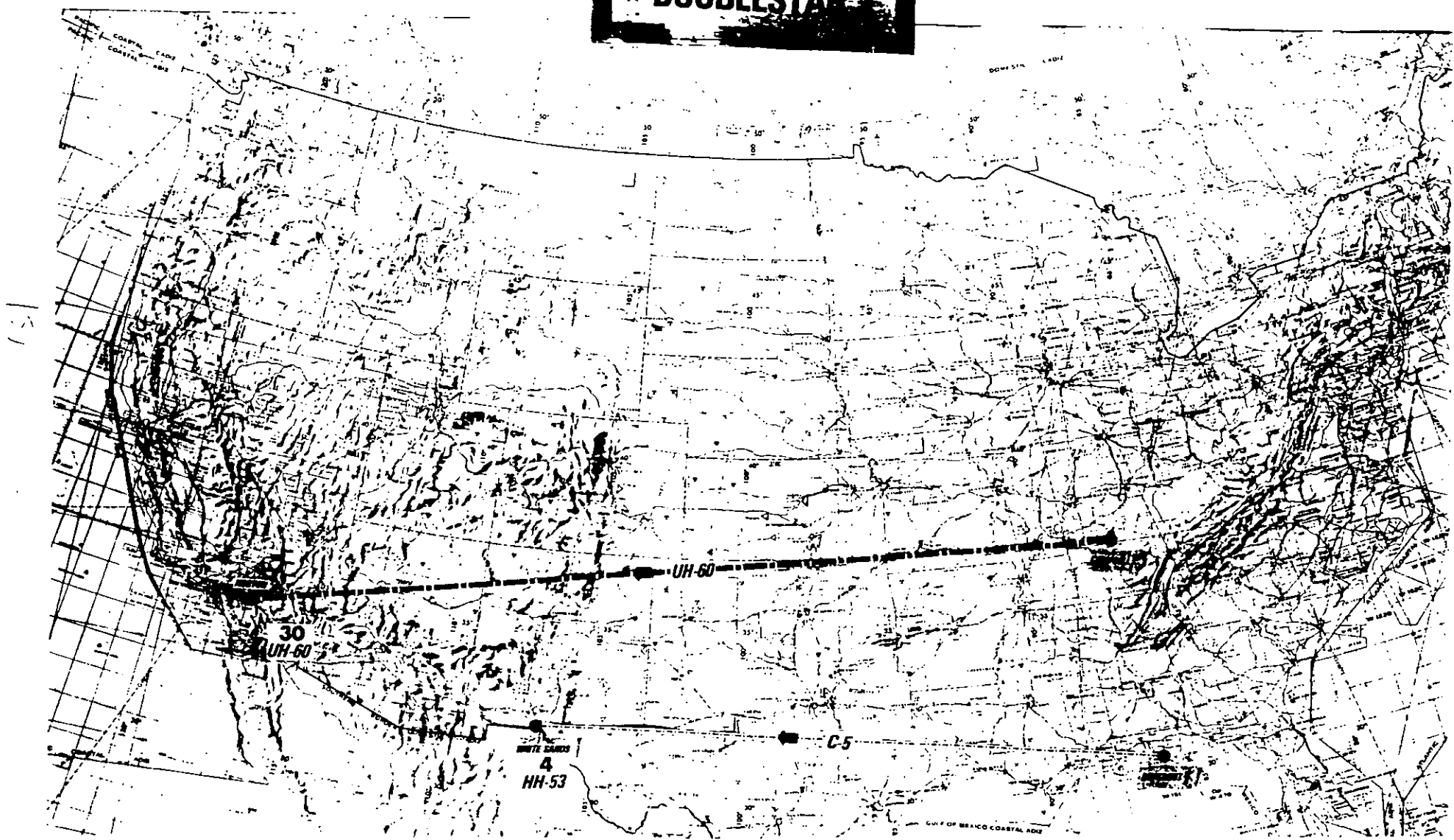

1
2



~~TOP SECRET~~
DEFENSE INTELLIGENCE AGENCY

WASHINGTON, D.C. 20301

21 JUL 80
FNS/STC
J-86

TS-DB-4/S

21 July 1980

MEMORANDUM FOR MAJOR GENERAL VAUGHT

SUBJECT: Feasibility Study (U)

(U)
(TS//NOFORN) We have considered the difficult challenge posed in your request for ideas on a feasibility study, dated 2 July 1980. As noted in our response of 9 July 1980, specific location of the targets would be critical to the relative merits of any proposed insertion method. Subject to that caveat, and to the further caveat that we offer ideas for consideration rather than carefully weighed recommendations, we offer the following thoughts:

-- Commandeer Iranian helicopters in Italy: The 10 new Iranian Air Force CH-47C Chinook and 4 overhauled Iranian Navy SH-3D Sea King helicopters at Augusta Bell facilities in Italy could be commandeered by U.S. air crews. Despite stringent demands by the GOI, these aircraft have not been delivered to date due to the U.S. embargo. If Iran were notified that the aircraft were now available, crews would be dispatched and flight plans and airspace clearances would be filed for the return flight through Yugoslavia, Greece, and Turkey. The aircraft and crews could be commandeered after the aircraft were turned over to Iran and, using the prefiled flight plan, clearances, call signs and frequencies, the aircraft could return to Iran (about a 3 day trip) with a surreptitious stop at a U.S. facility in Turkey to pick up the prepositioned strike force. Penetration of Iranian airspace would not be difficult as the aircraft would be expected. Refueling may be required in Iran and for this purpose, several of the aircraft could be provided fuel bladders while in Turkey. Upon arrival in Iranian airspace, some of the helicopters could disperse to remote hostage locations while others proceeded to Tehran. All helicopters could rendezvous at a predesignated and secured airfield for extraction by C-130/C-141 aircraft.

-- Infiltrate Force Via Indigenous Dhows onto remote Iranian Coastline: The strike force could tie into the centuries-old Omani-Baluchi smuggling rings on both sides of the Persian Gulf. The force could be smuggled into Iran via well-used Omani-Baluchi sea and land routes. Using the Dhows which ply the gulf waters regularly and in unlicensed freedom, the force could be inserted into southern or southeastern Iran and then guided to areas where hostages are held. The cooperation of Omani authorities or the British-officered Sultan's Armed Forces could probably be solicited for assistance in gaining access to smuggling routes and techniques.

*Declassified by
DDO n mcc
4/11/92*

Classified By: *DIA*
Declassified ON: *OADR*

~~TOP SECRET~~

WORKING COPY

~~TOP SECRET~~

-- Commandeer an Iranian Commercial or Military Aircraft: Iranian military and cargo aircraft regularly depart Tehran International Airport for either European or Middle Eastern countries in order to procure foodstuffs or commercial/military goods. The strike force could be placed aboard these aircraft, after the crew has either been captured or bought off. The aircraft would be flown overtly back to Iran to the designated airport with the strike force aboard. While confiscation of a civilian aircraft may be construed to be air piracy, commandeering a military aircraft would be less clearly defined under the law, especially in view of current U.S./Iranian relations.

-- Create a Radar Gap in Iranian Coverage: A small specially trained force dropped from a freighter or submarine in the Persian Gulf to capture or destroy an early warning radar for example, Kish Island, for a period of time sufficient for the rescue aircraft to penetrate the radar coverage. This method could reduce the flight time required by flying a more direct route to the objective.

-- Military Air Drop: The U.S. strike force to release the hostages could be delivered to an area near the target areas via commercial aircraft using the cover of a scheduled cargo flight. The troops and equipment could be parachuted into and/or landed at secured areas.

-- Railway Traffic Overland Through Turkey: The railroad between Turkey and Iran, an extension of the Orient Express Railroad connection from Europe to Asia, could be used to transport personnel and equipment of the strike force overland into the target areas. The train would have to be controlled by Turks or Iranians who are experienced in this mode of transportation and who have the capability of getting the train and its contents to the urban areas where the hostages are being detained. Perhaps an entire train could be assembled in Europe for a Tehran destination. Strike force could be dismounted at a selected location enroute.

-- Over the Beach Operation from Ships at Sea via Military Landing Craft: Personnel and equipment of the U.S. strike force could be brought into the Persian Gulf or the Arabian Sea area via ocean going ships of the line and then could be disembarked from these mother ships via Landing Ship Transports (LST) or other naval craft and dropped off at the beach in a remote area where these personnel could then assemble and set up a base for conducting the hostage release operation.

-- Infiltrate Force Via Commercial Freighter at an Iranian Port: The strike force could be placed aboard a commercial freighter of international registry scheduled to call at a specific Iranian port. The ship could sail into the Persian Gulf with the strike force and its registered cargo aboard and put in at Abadan or Khorramshahr (or another principal Iranian port). Upon arrival, the strike force could be met by guides and dispatched to specific areas of operation to release the hostages. In a variation, strike force could pose as crew members/passengers on one or more vessels.

-- Truck Convoy Overland Through Turkey: Turkey and Iran have extensive amounts of commercial trucks transit the border carrying commercial goods in both directions from one country to another. The strike force could be inserted into Iran and taken to their destination in a convoy of commercial trucks carrying foodstuffs or other goods into Iran to the urban areas where the hostages may be kept. Upon arrival via truck into the specific target areas, the members of the strike force could be guided to rendezvous points in order to conduct the hostage release mission. Pakistan and Iran have less truck traffic; but this means could be used.

-- Confiscate the 2 Fokker Aircraft and/or Iranian 707s being Refurbished in Europe: Coordinate an operation to have the Fokker company and/or the Lufthansa corporation complete work on the Fokkers and/or the 707s now in Europe. Arrange for a specific delivery date. When the Iranian crews arrive to bring the aircraft back from Europe, either bribe or incarcerate the pilots and crew and fly the aircraft on the overt flight schedule back to Iran with the strike force aboard.

Note that these suggestions have not been evaluated for military or political feasibility or legal implications. As stated in the opening paragraph, the location of the hostages is critical to any assessment of the means by which a force to release them might be introduced and, with the hostages, brought safely out. In this connection, a further thought is that one may confidently assume that the hostages will be held at locations deep in Iran. Options which envision, or permit, only shallow incursions into Iran are therefore unlikely to suffice.

Edward M. Collins
EDWARD M. COLLINS
Vice Director for
Foreign Intelligence

J-87

~~TOP SECRET~~

G

Briefing By Col. [REDACTED]
DA RQ
week of 16 June 80

PURPOSE

TO PROVIDE OPERATIONAL CONCEPTS AND CONSIDERATIONS FOR AIRBORNE

SEIZURE OF AN AIRFIELD

5-87

~~TOP SECRET~~

Classified By: ~~3ES~~ DDONMCC
Declassified ON: OADR 4 Aug 92
Downgraded to Secret
by DDONMCC

~~TOP SECRET~~
~~TOP SECRET~~

OVERVIEW

~~AA~~ ~~(S)~~ MISSION: SEIZE AIRFIELD; HOLD AIRFIELD 5-8 HOURS; WITHDRAW ON ORDER

~~AA~~ ~~(S)~~ ENEMY: AIRFIELD DEFENDED BY A PLATOON(-) SECURITY FORCE; ESTIMATE
22-26 SOLDIERS; FORCE HAS SMALL ARMS AND AUTOMATIC WEAPONS;
SECURITY FORCE HAS VEHICLES (JEEP/TRUCK TYPE). FORCE IS NOT WELL
TRAINED OR ORGANIZED

~~TOP SECRET~~

~~TOP SECRET~~

PLANNING CONSIDERATIONS

PLANNING/PLAN

INTEL/THREAT

GROUND ASSAULT FORCE

COMMAND, CONTROL AND COMMUNICATIONS

LOGISTICS

SPECIAL EQUIPMENT/WEAPONS

~~TOP SECRET~~

JOINT

CENTRALIZED

REVERSE SEQUENCE

SIMPLE

FLEXIBLE

ALTERNATIVES

CONTINGENCIES

ABORT

DETAILED

THOROUGH KNOWLEDGE OF UNIT/INDIVIDUAL MISSIONS

REQUIRED FORCE

THREAT

MISSION (DURATION, METHOD OF ENTRY)

LOCATION

AIRFIELD SIZE

~~TOP SECRET~~

PLANNING/PLAN (CONT'D)

METHODS OF DELIVERY

AIRLAND

PARACHUTE (LOW LEVEL, HALO, HVY DRP)

LAPES (NEED LEVEL AREA AND GOOD APPROACHES)

ACCURACY

(S) [REDACTED] SURPRISE

A

[REDACTED] ABSENCE OF UNIT/ARRIVAL AT ISB (IF USED)

[REDACTED] OPERATIONS TO [REDACTED]

REHEARSALS

FULL SCALE MOCK-UPS ON SIMILAR TERRAIN - ALL WEATHER CONDITIONS -

DARKNESS

EXERT STRESS ON EQUIPMENT AND PEOPLE

PRACTICE CONTINGENCIES

~~TOP SECRET~~

~~TOP SECRET~~

INTEL/THREAT

~~(A)~~ OBJECTIVE AND OBJECTIVE AREA

AIRFIELD (FACILITIES, EQUIPMENT, MINES, OBSTACLES SENSORS, ETC).

BUILT-UP AREAS

LINE OF COMMUNICATION (ROADS, TELEPHONE, RADIO)

CIVILIAN CONTROL

ENEMY FORCES

LOCAL AND REINFORCING

SIZE

QUALITY (REGULAR, PARAMILITARY

WEAPONS/VEHICLES/EQUIPMENT

DEFENSIVE POSITION

AIR DEFENSE WEAPONS

GUARD POST & PATROLS

ROUTINE

REACTION TIME

PROBABLE COURSE OF ACTION

AIRCRAFT - HIGH PERFORMANCE,

HELOS

TIMELY & ACCURATE.

~~TOP SECRET~~

~~TOP SECRET~~

GROUND ASSAULT FORCE

ADEQUATE FOR MISSION

THOROUGHLY BRIEFED, REHEARSED; VIOLENT, SWIFT, DECENTRALIZED EXECUTION

ORGANIZATION AND SIZE

ASSAULT

SECURITY

AIR DEFENSE

COMMAND GROUP (CDR, SIGNAL, CCT, ALO, ALCE, MEDICAL, EOD, INTERPRETERS)

DIRECT ACTION TEAMS

PARTISAN/OTHERS

RESERVES

FIRE SUPPORT (MORTARS, ARTY IF NEEDED, CAS)

WEAPONS/EQUIPMENT (TAILORED TO MISSION, ETC).

MOBILITY (ESPECIALLY FOR SECURITY FORCES)

~~TOP SECRET~~

~~TOP SECRET~~

COMMAND, CONTROL AND COMMUNICATIONS

UNITY OF COMMAND (CLEAN AND SIMPLE)

SELECTION OF PERSONNEL

THOROUGH KNOWLEDGE (BY ALL PERSONNEL - CHAIN OF COMMAND)

RESPONSIVE

SECURE EQUIPMENT

SILENCE, MINIMAL TRANSMISSIONS

REDUNDANT

LIGHT

EW/C-EW

IN-FLIGHT COMMUNICATIONS (PROVIDE CAPABILITY TO MODIFY SEQUENCING AND FORMATION OF ACFT ENROUTE)

~~TOP SECRET~~

~~TOP SECRET~~

LOGISTICS

FOLLOW ON SUPPLIES (AMMO, POL)

REPLACEMENT OR NEEDED EQUIPMENT

MEDICAL PERSONNEL, EQUIPMENT AND EVACUATION

~~TOP SECRET~~

~~TOP SECRET~~
SPECIAL EQUIPMENT/WEAPONS

~~A~~ EQUIPMENT/WEAPONS

A
ENGINEER EQUIPMENT [REDACTED]

LASER TARGET DESIGNATORS

WEAPONS CARRIERS

HELICOPTERS (CAV/RECON PACKAGE)

1/2 TON W/TOW

NIGHT VISION EQUIPMENT

MOBILITY FOR SECURITY FORCES

A
[REDACTED]

~~TOP SECRET~~

~~TOP SECRET~~

OPERATIONAL CONCEPT

PRE-ASSAULT

ASSAULT

FOLLOW-ON

EXTRACTION

~~TOP SECRET~~

~~TOP SECRET~~

PRE-ASSAULT PHASE

DIRECT ACTION

INFILTRATION

SURVEILLANCE

TIMELY INTEL. (IN FLIGHT)

ENEMY COMMO, EARLY WARNING

TERMINAL GUIDANCE

PARTISAN

COMMAND AND CONTROL

COMMO - DA, TM, AWACS, AIRCRAFT

ASSESS SITUATION-WEATHER, THREAT, LOSS OF EQUIPMENT/PERSONNEL

MODIFY PLANS, FORMATIONS, MISSIONS ENROUTE TO OBJ.

~~TOP SECRET~~

~~TOP SECRET~~

ASSAULT PHASE (CON'T)

COMMAND GROUP - COMMO WITH ALL, CCT, ALCE, ALO, MEDICAL, EOD, INTERPRETERS
-ASSESS SITUATION
-ADDITIONAL FORCES, EQUIPMENT, FIRE SUPPORT

CONSOLIDATION

CLEAR ALL RESISTANCE
ESTABLISH PERIMETER
REDISTRIBUTION/REORGANIZATION
CASUALTIES
POWS/DETAINÉES
COMMO WITH SECURITY TMS

~~TOP SECRET~~

~~TOP SECRET~~

FOLLOW-ON PHASE

FOLLOW-ON ECHELONS (AS REQUIRED)

RAPID UNLOADING

REORGANIZATION

DEPARTURE

BACKHAUL

WOUNDED

POW

NON-ESSENTIAL PERSONNEL/EQUIPMENT

~~TOP SECRET~~

~~TOP SECRET~~

EXTRACTION PHASE

EXECUTION

RAPID
THOROUGHLY REHEARSED
CENTRALIZED CONTROL

SEQUENCE

WOUNDED
NON-ESSENTIAL PERSONNEL-EQUIPMENT
BULK OF PERIMETER
SECURITY FORCES/CMD. GROUP

CONSIDERATION

DESTRUCTION, - FACILITIES, EQUIPMENT
AIR-COVER
POLICE-BATTLEFIELD
STRICT ACCOUNTING FOR PERSONNEL/SENSITIVE MATERIAL
ALTERNATE EXTRACTION PLANS
ESCAPE AND EVASION

~~TOP SECRET~~



2 June 1980

THE JOINT STAFF

MEMORANDUM FOR MAJOR GENERAL VAUGHT

Subject: "Backburner"

1. (U) (S) Recommend your agreement with the basic thrust of the approach.
2. (U) (S) The actual definition of this is perception management. One of the problems with such programs is that the measures that are undertaken are liable to be so subtle that they are missed by the target audience. Therefore, recommend that one of the DOD actions be a withdrawal of the carrier task groups from the Indian Ocean.
3. (U) (S) As you have indicated, it is essential to bring in the hostage families at an early date. There is no reason that they cannot know almost every aspect of such a program. To ignore them is to risk their appeal to the press during a period of high domestic political sensitivity.

If we are able to coordinate the activities of the families, they can be of assistance by creating an illusion of well being among the hostages, releasing light, encouraging news items from hostage letters. Such assistance would support the second objective, page "3".

4. (U) I have asked LTC [REDACTED] to provide you a separate paper on "Backburner".

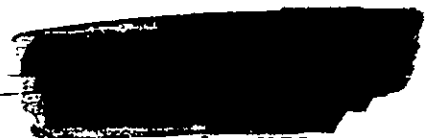

Colonel, USA
Chief of Staff

CLASSIFICATION REVIEW EO 12356
 CONDUCTED ON 4 Aug 92
 DERIVATIVE CL BY DDA/MCC
 DECL DOWNS TO _____
 REVM ON OAR
 RECEIVED FROM multiple

Classified By: JCS
Declassified ON: OAR



2 June 1980

THE JOINT STAFF

MEMORANDUM FOR MAJOR GENERAL VAUGHT

Subject: Psychological Operations Support for SNOWBIRD (S)

1. (U) (S) Subsequent to your discussions and my meeting with MGen Schweitzer on 28 May, MGen Schweitzer provided two papers to JTF outlining a general concept for, and means to implement, an umbrella perception management program designed to facilitate the release of the hostages from Iran. The papers set forth two general objectives: to foster the perception in Iran that the US has forgone plans to use force to gain release of the hostages and to facilitate development of a strong central government in Iran which will be capable of both releasing the hostages and dealing with the internal and external problems facing that country.
2. (U) (S) The concept and means of implementation outlined in MGen Schweitzer's papers, while ambitious, are feasible and necessary. What is called for is, in effect, an unconventional strategic PSYOP campaign of great subtlety, using multiple, mutually reinforcing channels of communication and actions to produce the desired Iranian government behavior. The idea of creating a national-level group to implement such a strategy (as called for in Col [REDACTED] PSYOP Plan) was discussed with MGen Schweitzer. It was his opinion that such an organization was not politically feasible and that even if such a group could be formed, the possibility of the group's existence being leaked to the Iranian government, with subsequent disastrous results, was so great that such a course of action should not be considered. Rather, what MGen Schweitzer proposed was that the required actions be taken informally, using Dr. Brzezinski, Mr. Aaron, and Mr. Nimitz as prime "facilitators". The general concept was briefed to Dr. Brzezinski by MGen Schweitzer and was favorably received.
3. (S) MGen Schweitzer strongly emphasized the need to, on the one hand, begin the operation as quickly as possible, and on the other to proceed very slowly and carefully. Any indication to the Iranian government that the US is attempting to influence and/or manipulate their behavior would trigger

SECRET

an immediate reaction which could result in irreparable damage, and preclude any possibility of future successful military action. In this regard, I propose the following course of action:

G a. With the concurrence of CJCS, and in concert with MGen Schweitzer and selected officers from his staff (Col [REDACTED] LTC [REDACTED] and Maj [REDACTED], establish working level contacts with appropriate members of the NSC staff, [REDACTED]

C [REDACTED]; this could be accomplished as soon as possible. Contacts with other agencies (State, DCA, Justice, Commerce, Treasury, etc.) would initially be indirect and would be carefully established under NSC auspices for specific actions; no indication of the existence of an overall strategy should be provided.

b. A series of small actions and communications should be initiated through various means to suggest that the US is beginning to have second thoughts about using military force as an option for hostage release. These actions and communications should be indirect and mutually supportive; intensive analysis should be undertaken after these "seeds" are planted to determine if, and in what manner, the desired perceptions reach the Iranian hierarchy. The process should be repeated, using a slightly different theme, through other means, until a number of viable channels of influence have been identified from source to ultimate Iranian receiver, i.e. Khomeini.

c. Once multiple channels have been identified and are understood, a series of larger, mutually supportive actions and communications should be initiated. These actions and communications should be designed to raise the perception of Soviet activity in the region, and should be of sufficient magnitude that they will trigger an overt response of some type from the Iranian government (a statement by the Foreign Minister, a broadcast by Radio Tehran, increased state of alert by gendarmerie posts in a given region, etc.). The Iranian response would then be carefully analyzed to identify the relationships among the channels used, the Iranian motivation for the response, the form of the response, and the internal effect of the response on the Iranian public.

d. Having identified the channels of influence, analyzed the response and determined the effect of the response, the operation can begin to increase in momentum, proceeding toward the objectives. Obviously, the process is an iterative one, and extreme care must be taken at all stages to insure that no entity used to create a desired perception (US, Iranian or Third country) is aware of the ultimate manipulative intent of the operation.

~~SECRET~~

~~SECRET~~

A

4. (S) There are a number of additional considerations related to an operation such as this. While the operation is intended to support and should provide excellent [redacted] care must be taken to insure that if the operation is [redacted] SNOWBIRD will remain uncompromised. Many, if not most, of the participants in this operation will remain [redacted] in the overall process. Such individuals, particularly those in non [redacted] related positions can be expected to be [redacted]. Beyond such "moral" considerations, certain of the actions proposed in the implementation are on very tenuous legal ground, particularly those involving [redacted]. Such legal considerations are unlikely to pose any real constraints on the operation, but should be born in mind in the event that the operation is compromised and [redacted].

C

5. (S) In summary, I believe that the concept and proposed implementation provided by MGen Schweitzer are viable and feasible. The desired objectives cannot be reached overnight, but with needed support and cooperation from the [redacted] and a large dose of effort and imagination from working level participants, I believe we can get the job done. With your concurrence, I propose to begin the steps outlined in this memorandum immediately.

G

[redacted]

LtCol, USAF

~~SECRET~~

260300R April 1980

THE JOINT STAFF

MEMORANDUM FOR THE RECORD

Subject: EC-79 Casualties

1. The four burn casualties; Maj Petty, Maj Schaeffer, 1st Lt Harrison and SSgt Beyers are enroute via C-9 to Kelly AFB, San Antonio, TX. ETA: 261300R Apr 80. They will be in the care of Brook Medical Center, Institute of Surgical Research. POC: Col [REDACTED] AV 471-4604/2943/3301, Home AC [REDACTED] McManus is the only member of his organization that knows of the casualties and intends to make arrangements for security and transportation two hours before the arrival of the patients.

2. Airman Tootle, only suffering a sprained right knee, will be taken to Wofford Hall Medical Center, Lackland AFB in San Antonio. He will be under the care of Dr. [REDACTED] ph no. AC 512 670-7352, home AC [REDACTED]

3. Both [REDACTED] and [REDACTED] were briefed by the undersigned that the patients may be unduly subjected to press harassment and numerous inquiries. Both were told that the undersigned had the sole authority to clear anyone who requested to speak to the patients about operational matters.

[REDACTED]
Colonel, USA
General Staff

~~SECRET~~

~~CONFIDENTIAL~~

UNITED STATES ARMY

THE CHIEF OF STAFF

1 AUG 1980

MEMORANDUM FOR THE PRINCIPAL DEPUTY UNDER SECRETARY OF DEFENSE FOR
RESEARCH AND ENGINEERING

SUBJECT: Joint Operational Test and Evaluation Project "DOUBLESTAR" (S)

1. (U) (S) Your memorandum of 6 June 1980, SAB, tasked the US Army to participate in a Joint Operational Test and Evaluation Project, DOUBLESTAR (S). The Army was identified as the Executive Service for support of the project and preliminary funding requirements for the Army were set in the amount of \$12.5 million.
2. (U) (S) The initial training and evaluation requirements established by the DOUBLESTAR (S) Joint Test Director have been accomplished. However, Army costs associated with this initial phase are currently estimated at \$22.0 million. Sensitive procurement account limits and thresholds have been reached. As a result, without fiscal relief the Army is unable to support additional requirements in accomplishment of DOUBLESTAR (S) objectives.



E. C. MEYER
General, United States Army
Chief of Staff

CF:
CJCS ✓
CSAF

CLASSIFIED BY: JCS, J-3

REVIEW ON: 6 June 2000

~~CONFIDENTIAL~~



~~CONFIDENTIAL~~

THE JOINT CHIEFS OF STAFF
WASHINGTON, D.C. 20301

J-96

5 August 1980

THE JOINT STAFF

MEMORANDUM FOR THE RECORD

Subject: Compatibility Tests of UH60A BLACKHAWK
Aboard Navy Ships

1. At 1330 hrs, 4 Aug 1980 at COMNAVSURFLANT Hqs, Norfolk, VA, a coordination meeting was held to establish dates for a compatibility test of the UH-60A BLACKHAWK helicopter aboard a US Navy CV, LPH and LHA. TAB A is a list of attendees.
2. JTD established the following ordered priorities for guidance in selecting a date: (1) Complete the test ASAP, (2) Minimize impact on ships' preparation for overseas movement (POM) cycle and (3) Minimize adverse impact on other 101st Aviation Group requirements.
3. The following dates were established for the tests:

18 Aug	CV	Independence
19 Aug	LHA	Saipan
20 Aug	LPH	Iwo Jima
4. The 101st Aviation Group, 101st Abn Div, was tasked to direct the test and collect data. The other agencies will provide assistance as required.
5. Basic test objectives are as stated in message at TAB B. Two helicopters will be flown aboard each ship for conduct of the test. Ships personnel will do ground handling and 101 Group personnel will do all disassembly and reassembly. UH-60A unique equipment (blade racks, poles, tail wheel tow yoke, lifting sling, etc.) will be provided by 101 Group.
6. MTMC TEA test objectives are at TAB C. They will be incorporated to the extent possible. Test of the positioning device will be aboard the Iwo Jima only. TEA will arrange to deliver the device to Norfolk.
7. JTD agreed to arrange for the following: (1) A fund site for shore crane to lift positioning device (1200 lbs) on and off the Iwo Jima if ship's cranes cannot do this (J-4), (2) provide a JTD representative in Norfolk for the test

~~CONFIDENTIAL~~

Classified By: *DDON/mcc*
FCS 4ax592
Declassified ON: *OADR*

~~CONFIDENTIAL~~

(J-3) and (3) task Naval Air Engineering Center to compute the A-7 and CH-46 equivalents for the UH-60A with only main rotors folded (Navy).

r1) 8. It should be noted that CDR, Tradoc, the agency directed to coordinate the test, (see msg TAB B) did not send a representative to the meeting. JTD assumed the position as test coordinator.

G

MAJ, IN, US Army

~~CONFIDENTIAL~~

~~CONFIDENTIAL~~

TAB A

List of Attendees

	<u>Name</u>	<u>Organization</u>	<u>Autovon</u>
CDR	[REDACTED]	COMNAVSURFLANT, N33	690-5951
CDR	[REDACTED]	COMNAVAIRLANT N322	690-7661
LCDR	[REDACTED]	COMNAVSURFLANT N312	690-5218/5250
MAJ	[REDACTED]	COMNAVSURFLANT N624 (Army LNO)	690-5605
MAJ	[REDACTED]	COMNAVSURFLANT N624 (Army LNO)	690-5605
LTC	[REDACTED]	Tran/School, Test and Eval	927-5409
MAJ	[REDACTED]	Tran/School, ATSP-CD-MS	927-3040
Mr.	[REDACTED]	Tran/School, Test and Eval	927-2340
Mr.	[REDACTED]	Tran/School, Test and Eval	927-4395
CPT	[REDACTED]	101 Avn GP	635-6002
CW4	[REDACTED]	101 Avn GP	635-5120
CPT	[REDACTED]	MTMC, Tran Eng-Agency	927-5266
MAJ	[REDACTED]	OJCS, JTD	225-5078

G

~~CONFIDENTIAL~~

~~CONFIDENTIAL~~

PENTAGON TELECOMMUNICATIONS CENTER

RTTCZYUW RUEADWD1710 1850126
ROUTINE
R 021953Z JUL 80
FM HQ DA WASHDC //DAMC-CDP//
TO RUCLAIA/CDP TRADCC FT MONROE VA//ATCS-PC//
RUXGHTC/CDR HTMC WASHDC //MT-PL//
BT

~~CONFIDENTIAL~~
SUBJECT: COMPATABILITY TEST FOR BLACKHAWK (U) SPM 505-80
1. (C) IN CONJUNCTION WITH DA INITIATIVES IN SUPPORT OF THE POF,
AN URGENT REQUIREMENT EXISTS TO DETERMINE THE CAPABILITY

A

USN CVN, LHA AND LPH TO TRANSPORT THE UH-60 BLACKHAWK HELICOPTERS.

2. (C) TEST OBJECTIVES

LIMITED TO:

A. (C)

B. (C)

C. (C)

D. (U) REQUIREMENTS FOR SPECIAL HANDLING/POSITIONING EQUIPMENT.

3. (U) LET TEST OBJECTIVES FOR USN SHIPS AS A MINIMUM MUST INCLUDE:

A. (U) LET IDENTIFICATION OF DISASSEMBLY REQUIREMENTS FOR MOVING UH-60'S TO HANGAR DECKS.

B. (U) LET CAPABILITY OF SHIP'S GROUND HANDLING EQUIPMENT TO MOVE UH-60.

C. (U) LET ASSEMBLY/DISSASSEMBLY TIME, EQUIPMENT AND PERSONNEL REQUIRED TO COMPLETE CYCLE OF OPERATIONS ENCOMPASSING MOVEMENT OF A UH-60 FROM DECK TO STORAGE, RETURN TO DECK AND PREPARED FOR OPERATION.

4. (U) LET REQUEST CDR TRADCC COORDINATE OVERALL TEST IN CONJUNCTION WITH CDR HTMC TO ACCOMPLISH REF OBJECTIVES.

5. (U) ARMY STAFF POC IS [REDACTED] DALO-AV AV 227-0487.

6. (U) USN POC IS [REDACTED] (AV/227-1192).

7. (U) AIRLANT LIAISON OFFICER WILL BE APPOINTED AS REQUIRED.

DECL CN 2 JUL 1984

BT

ACTION: DAMC(12)

(F)

TOTAL COPIES REQUIRED 12

MCN=80185/01822 TCP=80195/01267 TAD=80185/01267 COSM=PR0247

~~CONFIDENTIAL~~

PAGE 01 OF 01
021953Z JUL 80

~~CONFIDENTIAL~~



DEPARTMENT OF THE ARMY
MILITARY TRAFFIC MANAGEMENT COMMAND
TRANSPORTATION ENGINEERING AGENCY
12388 WARWICK BOULEVARD, P.O. BOX 6276
NEWPORT NEWS, VIRGINIA 23605

MTT-OA

SUBJECT: Compatibility Test for Blackhawk (U)

Commander
USATSCH

G
ATTN: ATSP-CD-TE [REDACTED]
Fort Eustis, VA 23604

1. (U) References:

G
a. FONECON 22 July 1980 between [REDACTED], MTMCTEA, and [REDACTED] USATSCH.

b. Message, HQ DA, DAMO-ODP, 021953Z Jul 80, SAB.

2. (U) Referenced FONECON above requested MTMCTEA provide any test objectives desired to be considered for evaluation during the Blackhawk Compatibility Test as requested by reference 1b. These objectives are provided at Inclosure 1.

G
3. (U) Point of contact at this Agency is [REDACTED] AV 927-5266.

1 Incl
as

[REDACTED]
[REDACTED]
[REDACTED]
Deputy Director

CF:
MTMC (MT-PLM)

CLASSIFIED BY DAMO-ODP
.....
DECLASSIFY ON 2 JUL 84

~~CONFIDENTIAL~~

~~CONFIDENTIAL~~

MTMCTEA'S BLACKHAWK COMPATIBILITY TEST OBJECTIVES

1. (U)
(C) Vessel Preparation:

a. To land Blackhawk UH60 helicopters on the main deck does the vessel have obstructions that are required to be removed?

b. To facilitate landing and preparation of Blackhawk aircraft on the main deck are there obstructions that, if removed, would significantly increase the number of aircraft that can be processed?

c. Are there a sufficient number of tiedown fittings installed for the Blackhawk helicopters and other unit equipment?

2. (U)
(C) Aircraft Landing Operations on the Main Deck:

a. What areas of the vessel's main deck are suitable for landing operations?

b. How long does it take to prepare one aircraft for stowage once landed on deck?

c. What type of ground handling equipment and what quantities are needed to support this operation?

d. How many aircraft maintenance personnel are required? What types are required?

3. (U)
(C) Aircraft Preparation for Movement:

a. What areas on the main deck are best suited for preparation activities only?

b. What aircraft configurations are best suited for movement on board the vessel:

(1) Is movement with only the main rotor blades folded possible and practical? If not, what other components need to be folded or removed?

(2) Is movement of the helicopter with the tail boom folded a better configuration?

(3) With the helicopter tail boom folded, will this configuration fit on the vessel's elevator? If not, what other components require removal to make it fit?

~~CONFIDENTIAL~~

~~CONFIDENTIAL~~

(4) How many maintenance personnel will be required to perform the maintenance tasks to prepare the aircraft for its movement configuration? What maintenance tool kits are required? How many manhours are required?

c. What aircraft preservation techniques are required:

(1) If the aircraft is stowed above the weather deck?

(2) If the aircraft is stowed below the weather deck?

(3) How many maintenance personnel and manhours are required to perform the technique in (1) and (2) above?

(4) What types of materials and equipment are needed to perform the techniques in (1) and (2) above?

(5) What are the applicable technical manuals that are needed to accomplish these techniques?

(6) If aircraft components are removed, what preservation techniques will be employed?

(7) Are there bearing surfaces, or surface areas on the aircraft that require special attention if the aircraft is stowed either above or below the weather deck?

4. ^(U) ~~(S)~~ Aircraft Movement to Stowage Location:

a. What unit ground handling equipment and personnel are required for this operation?

b. Is the tow motor used in towing the aircraft capable of negotiating the 7 and 10 degree ramps on the vessel?

c. Does expanding the main landing gear struts provide adequate clearance for the aircraft to clear a ramp breakover angle of 7 or 10 degrees that exists on the vessel's ramps?

d. If the ramp breakover angle is excessive, what remedy is recommended as a standard operating procedure for moving the aircraft down ramps?

e. With the aircraft in tow what is the minimum turning radius of the aircraft coming off a ramp and on a flat deck surface?

~~CONFIDENTIAL~~

~~CONFIDENTIAL~~

f. Utilization of the MTNCTEA helicopter positioning device for final stow location:

- (1) Is the written instruction on the use of the device adequate for its operation?
- (2) How many personnel are required to move the aircraft sideways?
- (3) What improvements on the device if any are recommended?

5. ^(U)~~(S)~~ Tiedown Configuration of the Aircraft at Stowage Location:

- a. What is the optimal tiedown configuration for this aircraft?
- b. Does the use of 35K jock and Halc tiedown devices pose any structural problems on the aircraft?
- c. Do the main rotor blades in the folded position require packing materials to be placed on the tips of the blades to prevent damage caused by vessel movement?
- d. Are wheel chocks required in addition to the aircraft tiedown?

6. ^(U)~~(S)~~ Aircraft Discharge: The discharge sequence will be the reverse of the loading sequence. If problems are encountered, they should be noted for further evaluation.

7. ^(U)~~(S)~~ Aircraft Fly Off From the Main Deck:

- a. How many maintenance personnel are required? What types are needed?
- b. What types of equipment and what quantities are needed to support this operation?
- c. How many aircraft can be prepared for fly off from stowage in an hour?

~~CONFIDENTIAL~~

~~CONFIDENTIAL~~ MEMORANDUM

Date 5 Aug 80

To: Adm Gureck, M.G. Vaught

Subject: Info.

Gen Vaught: Note Par 8

8/5

G [redacted] Done job!

C/S

please send copy to

-DCSOPS - OP - Col J...

Done 6 Aug

G

[redacted]

~~CONFIDENTIAL~~

I N D E X

A

6

1. ~~████████████████████~~ Briefing for Operations Deputies
31 October 1980 (U)
2. C-5A Off-Pavement Testing (U)
3. C-5A Air Transportability Exercise (U)
4. C-5A Mission Profile (U)
5. Night Point Target Air Defense Capability (U)
6. JTF Command, Control and Communications (U)

IR-NIS OPS PLANS (DUP)(TS)

Classified By: ~~DDONMCL~~ 4AM592
 Declassified ON: OADR

~~SECRET~~

Point Paper for the Chairman, Joint Chiefs of Staff

A ~~(S)~~ I. SUBJECT. [REDACTED] Briefing for Operations
Deputies 31 October 1980 (U).

A ~~(S)~~ II. PURPOSE. To provide current [REDACTED] situation, brief two
options and provide recommendations for further [REDACTED] activity.

~~(S)~~ III. MAJOR POINTS:

A. Long Term Requirement

A - Be prepared to conduct [REDACTED]

B. Current Considerations

- Iran/Iraq war
- Lack of concensus within Iranian Parliament

C. Conditions Prior to Iraq-Iran War

- Poor state of internal alert/reaction
- Spotty radar coverage
- minimal air activity

D. Options Considered (Pre-War)

- A
- Truck infiltration
 - Use of [REDACTED]
 - Helo assault from Persian Gulf/Indian Ocean
 - Fixed wing introduction of helo force

E. New Conditions As A Result of War

- Increased Western Iran radar coverage
- Enhanced internal security/communications
- Significant IIAF activity in Northern Gulf
- Southern-Eastern area increasingly exposed

F. Effect of Conditions on Planning

- Ground insertion of assault force very difficult
- Cross-Gulf helo infiltration at high risk
- Infiltration route through Western Iran at high risk
- Early insertion at PEGGY-KATHY at high risk
- Assault directly into Mehrabad at high risk
- Infiltration from the South has reduced risk

CLASSIFIED BY DIRECTOR, J-3
DECLASSIFIED ON 30 OCTOBER 2000

~~TOP SECRET~~

~~SECRET~~

G. Recommended Option Under Pre-War Conditions

- SNOWBIRD 11 - JASPER/POTENT CHARGE Joint Helicopter Task Force (JHTF)

H. New Planning Consideration

- Increased alert status requires larger force on target, quicker
- Iranian attention is directed to Iraq and Western border
- Established airfields do not allow build up time for adequate force
- The situation that would require the military option would require quick, dynamic action. . . i.e., a desperate situation requiring desperate actions

I. Current Option Under Consideration (SNOWBIRD XII)

- C-5's launch from U.S. with strike force
 - Direct to LZ SUSAN
 - Target attacked within three hours
 - Exfil through Manzariyeh

J. Conclusion

A

- Under current situation in Iran:
 - ~~options~~ options must be expanded
 - Without the capability to get an UH-60 assault force close to the target quickly, chance of mission success is very low
 - The C-5 option appears to be the most viable
- Concept must be validated

K. Request

- Complete off-pavement testing
- Expand JTD TRAINEX to include C-5 assets

Point Paper for the Chairman, Joint Chiefs of Staff

I. SUBJECT: C-5A Off-Pavement Testing (U)

II. PURPOSE: To determine off-pavement operational capability of C-5A.

III. MAJOR POINTS:

A. C-5A was designed for off-pavement operations.

- Gear stressed to 571,000# gross wt.
- California Bearing Ratio (CBR) 9 is acceptable.
- Exhibits better flotation characteristics than C-130.

B. Original off-pavement testing conducted in 1970.

- Eight take-offs and nine landings successfully accomplished (16 were scheduled) at Harper Lake, California.

-- Incident on 9th landing resulted in cancellation of remaining testing.

--- Three of four engines were destroyed as a result of sand ingestion.

---- Maximum thrust reverse was used.

---- Engines were not properly trimmed (the 4th engine, properly trimmed was not damaged).

--- No other damage was incurred.

- Ground testing was conducted at Dyess AFB Texas.

-- Taxi tests, minimum radius turns on aluminum mat were successfully accomplished.

-- Tests were terminated due to failure of mats.

C. Testing was resumed in 1980 as a result of Congressional queries. Operational Utility Evaluation (OUE) conducted, Summer 1980.

- Purpose was to assess operational capability for off-pavement ground operations.

- Three operational sites were selected: Shaw AFB, Altus AFB and Eglin AFB.

-- Representative cross section of soil types evaluated.

-- CBR from 8.7 to 15+ evaluated.

- Taxi speed was limited to 10 knots.
- Gross weights up to 665,000# were provided.
- Initial testing was completed, August 1980; results were forwarded to CSAF.

D. Results of Operational Utility Evaluation (OUE):

- The OUE demonstrated the capability of the C-5A to perform typical ground maneuvers successfully.
 - Towing was successful in all modes with 10K and 6K R/T forklifts. Some problems with truck traction in sand was experienced..
 - No problems with cargo off-load were experienced.
 - Aircraft reliability, availability and maintainability were outstanding.
- For operational use of C-5s off-pavement, it was recommended that:
 - The hydraulic brake lines on the main landing gear should be relocated to protect the lines from damage.
 - Maintenance of the low pressure air system should be resumed.
 - Scanners should be positioned at the crew entrance door during taxi operations.
- Critical operational planning requirements were identified:
 - Soil strength to a depth of 24 inches should be determined by up-to-date penetrometer readings.
 - Soil type must be defined.
 - Take-off/landing capability in terms of numbers of consecutive operations must be determined.
 - Weather conditions and effects of weather must be predicted and monitored.
- Operational comparisons in normal and off-pavement ground operations were evaluated and reported.
 - Pilots assessed the C-5A handling qualities off-pavement as essentially the same as on normal surfaces.
 - Normal aircrew checklists and handbook procedures were used and were adequate for off-pavement operations.
 - No requirement was seen for additional training.

~~CONFIDENTIAL~~

~~SECRET~~
Point Paper for the Chairman, Joint Chiefs of Staff

I. SUBJECT: C-5A Air Transportability Exercise (U)

II. PURPOSE: Determine load and unload factors associated with tactical helicopter movement in C-5A.

III. MAJOR POINTS:

A. C-5A air transportability exercise conducted at Fort Campbell, Kentucky, and Eglin AFB (Hurlburt), Florida, during the periods 8-11 October and 28-29 October.

B. Following load/unload factors identified:

- C-5 taxi/kneel time: 20 minutes.

A - Army exercise loaded three UH-60's, one AH-1, three ~~_____~~ in two hours and fifteen minutes.

-- Unload time: twenty-nine (29) minutes from ramp down. Unloading and reassembly accomplished under blackout/red light conditions.

A -- AH-1 ready to fly immediately; ~~_____~~ minutes; three UH-60's ready in fifty-five minutes, fifty-nine minutes and one hour and four minutes respectively.

- Air Force exercise loaded two HH-53's in four hours from ramp down..

-- Unloading and reassembly accomplished under airfield portable light units.

-- Reassembly time: fifteen hours per HH-53 after unloading.

Attachment

TAB A - C-5A Helicopter Load Plan

CLASSIFIED BY DIRECTOR, J-3
DECLASSIFY ON 30 OCTOBER 2000

~~CONFIDENTIAL~~

~~SECRET~~

C-5 HELICOPTER LOAD PLAN

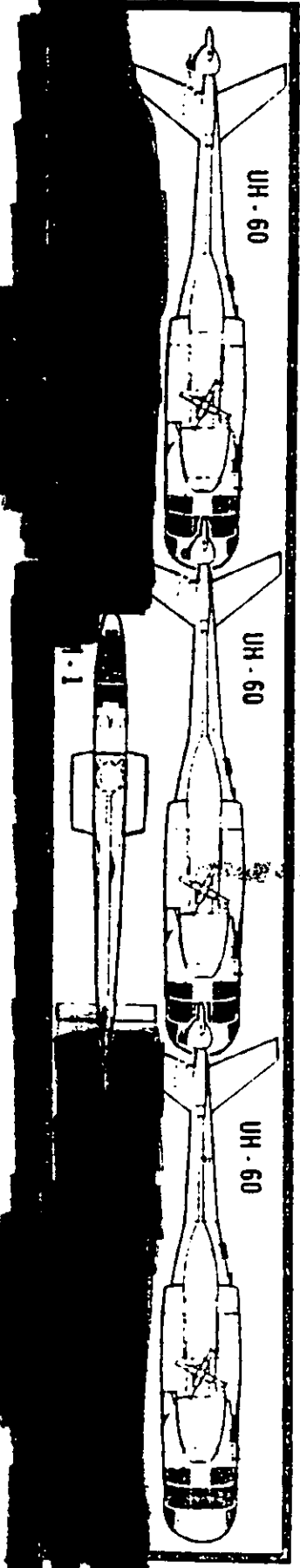

3 each UH - 60
1 each [redacted]
1 each AH - 1

A



~~TOP SECRET~~

Point Paper for the Chairman, Joint Chiefs of Staff

I. SUBJECT: C-5 A Mission Profile (U)

II. PURPOSE: To provide mission profile information relative to the exposure of the C-5A within Iran.

III. MAJOR POINTS:

A. Timing factors - Airborne:

- cruise speed - 350 knots
- altitude - 5000' or higher
- fly in from Southern Iranian coast to SUSAN - 720nm
- flight time - 2 hours

B. Timing factors - Ground:

- taxi - 10 min
- kneel - 20 min
- off-load - 45 min
- landing interval - 10 min
- 80 minutes required to land (8) C-5A's

C. Other Timing Data:

- EENT (last light) - 1735L
- BMNT (first light) - 0548L
- Assault on objectives -0030L
- C-5A fly out - 0140L

D. C-5A exposure:

- total C-5A exposure time (1st aircraft in to last out) - 7 hrs 40 min

Attachment

TAB A - C-5A Mission Profile

CLASSIFIED BY DIRECTOR, J-3
DECLASSIFY ON 30 OCTOBER 2000

~~TOP SECRET~~

~~TOP SECRET~~

Point Paper for the Chairman, Joint Chiefs of Staff

I. SUBJECT: C-5 A Mission Profile (U)

II. PURPOSE: To provide mission profile information relative to the exposure of the C-5A within Iran.

III. MAJOR POINTS:

A. Timing factors - Airborne:

- cruise speed - 350 knots
- altitude - 5000' or higher
- fly in from Southern Iranian coast to SUSAN - 720nm
- flight time - 2 hours

B. Timing factors - Ground:

- taxi - 10 min
- kneel - 20 min
- off-load - 45 min
- landing interval - 10 min
- 80 minutes required to land (8) C-5A's

C. Other Timing Data:

- EENT (last light) - 1735L
- BMNT (first light) - 0548L
- Assault on objectives -0030L
- C-5A fly out - 0140L

D. C-5A exposure:

- total C-5A exposure time (1st aircraft in to last out) - 7 hrs 40 min

Attachment

TAB A - C-5A Mission Profile

CLASSIFIED BY DIRECTOR, J-3
DECLASSIFY ON 30 OCTOBER 2000

~~TOP SECRET~~

C-5A MISSION PROFILE

Time (Local) 18 19 20 21 22 23 00 0045 01 02

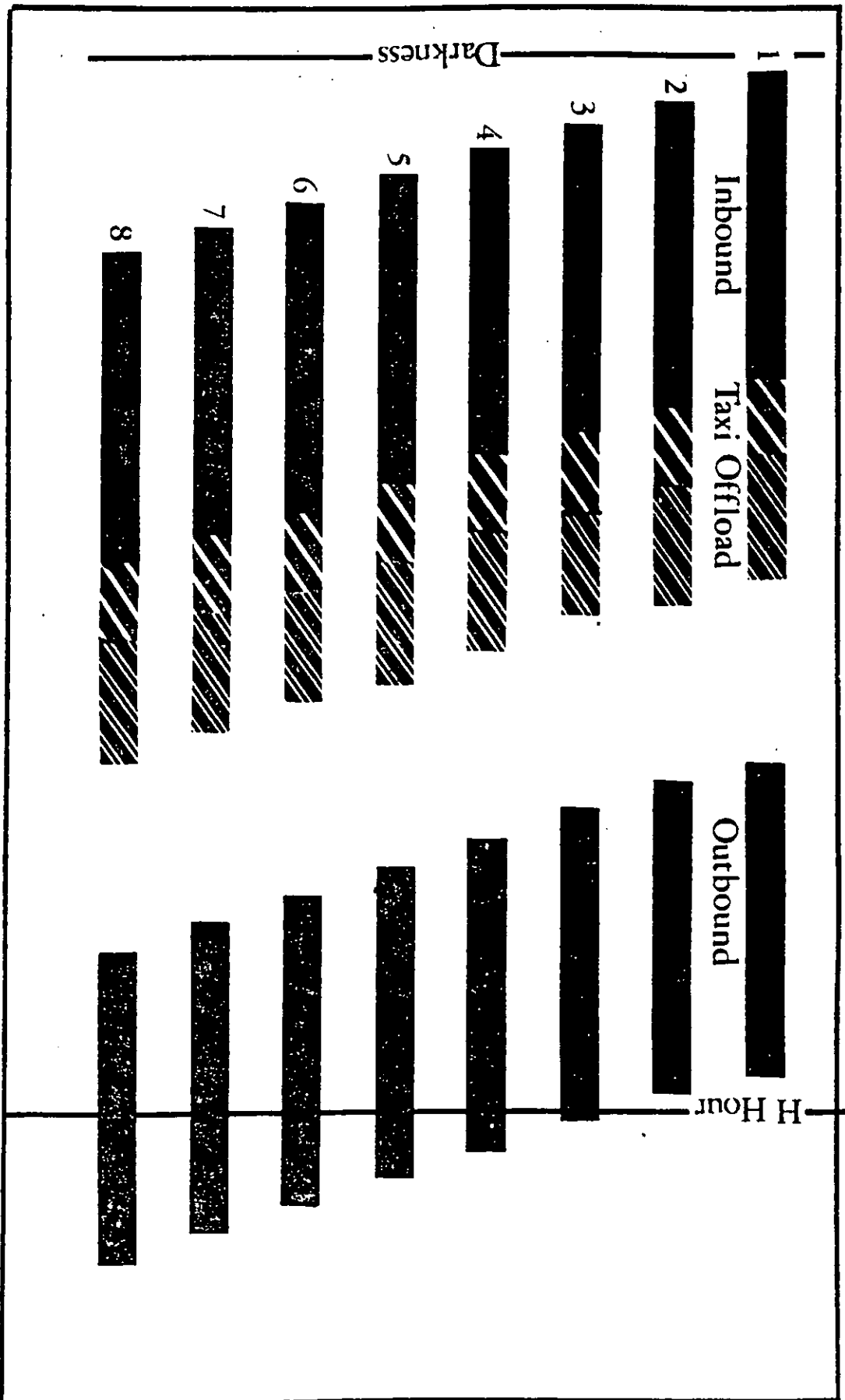

~~CONFIDENTIAL~~

+ hours
\$ / per day
-1000

8 MC-130
4 C-1191
24 HH60
28 AH116
3 AC130
C-5 FORCE

EMBASSY ASSAULT
FIRST
LAST

24 UH-60
8 AH-16

MFA ASSAULT
A

PEGGY

MC-130
C-141B

ANNE

MC-130

CAP PACKAGE

FIRST
LAST

AC-130

FIRST
LAST

EENT 1800 1900 2000 2100 2200 2300 2400 0100 0200 0300 0400 0500 0600 0700 0800
OTW
BMNT

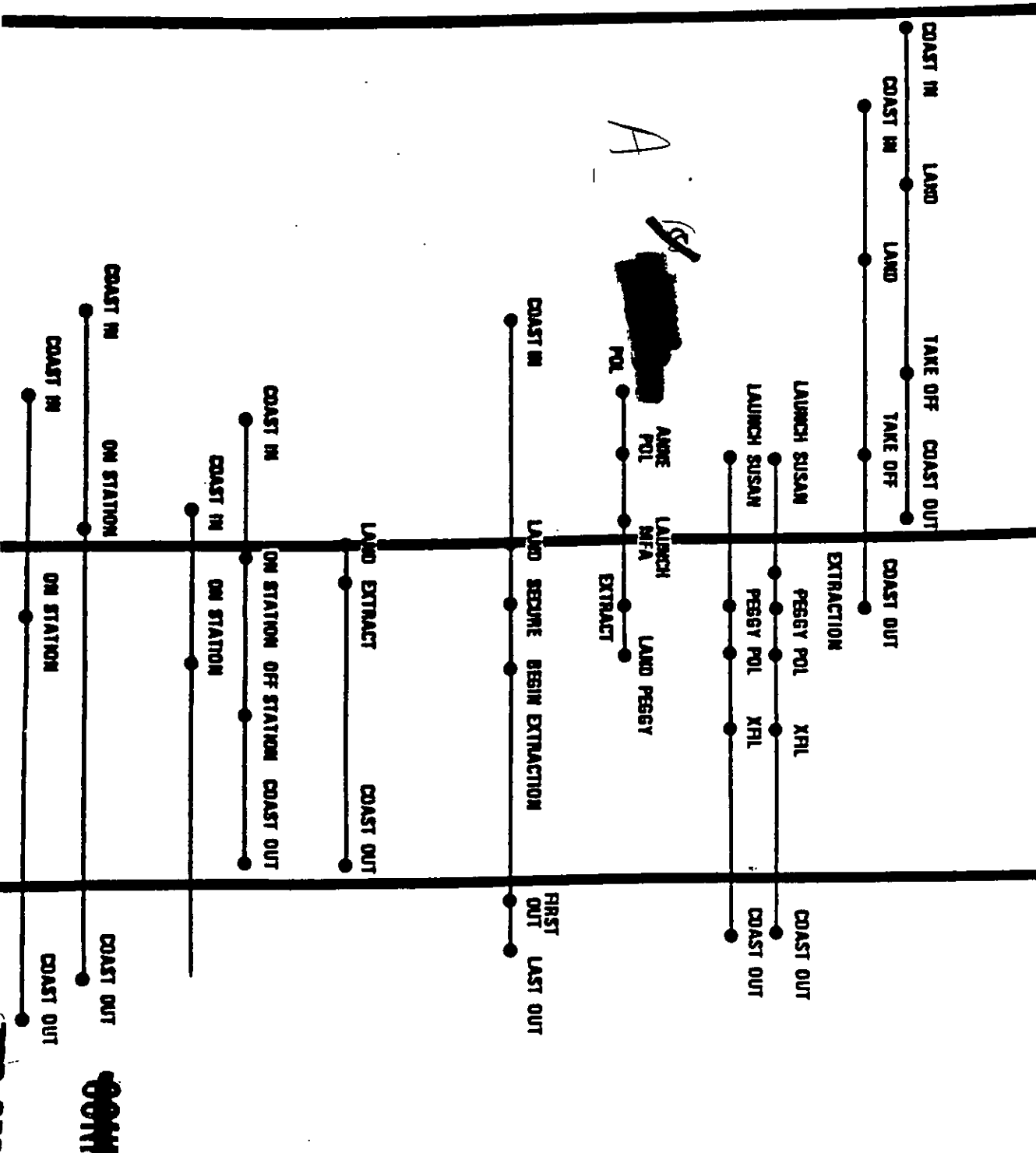

~~CONFIDENTIAL~~

Point Paper for the Chairman, Joint Chiefs of Staff

I. SUBJECT: Night Point Target Air Defense Capability (U)

II. PURPOSE: To provide rapid reaction and unconventional warfare forces with self-defense from air attack during night operations.

(S) III. MAJOR POINTS:

A. U.S. Army and U.S. Marine Corps units deploying without conventional air defense forces (e.g., HAWK and Nike Hercules) have no means of defending themselves from air attack during night operations.

B. Night Vision Laboratories, Fort Belvoir, is conducting an expedited development program for night vision devices tailored to allow firing

A

[REDACTED] towed Vulcan (20mm air defense gun) at night.

C.

[REDACTED]

A

A

[REDACTED] Rang [REDACTED] possibly Hurlburt).

D. The towed Vulcan night firing device also will incorporate the AN/PAS-7 Night Vision Device, specially mounted (non-destructively) to replace (rather than supplement) the integral sight.

CLASSIFIED BY DIRECTOR, J-3
DECLASSIFY ON 30 OCTOBER 1986

~~CONFIDENTIAL~~

- E. Prototype development ongoing. Firing test at Camp A. P. Hill scheduled during week of 3-7 November 1980.
- F. Anticipate six adapters available for issue 14 November 1980.
- G. Sufficient towed Vulcans available from 82d Airborne Division. Special night firing training would be conducted for selected gunners.

~~CONFIDENTIAL~~

Point Paper for the Chairman, Joint Chiefs of Staff

I. SUBJECT: JTF Command, Control and Communications (C)

II. PURPOSE: Provide C³ Information

III. MAJOR POINTS:

A. Command and Control:

- The Commander, JTF, is in full overall command of all forces, during all phases of the operation.
- First level JTF subordinate commanders are designated to command mission segments and resource packages; not their own single Service units.
- The number of mission segments established is tailored to the overall JTF mission and the resources and techniques available/utilized to accomplish it.
- In a complex operation there may be as many as 8 to 10 first level subordinate commanders. This implies an excessive span of control. However, the sequential nature of the mission segments and the extensive communications resources available to the JTF commander insure positive control of forces at all times.
- Positive control is further facilitated by JTF use of an Imperative Activity/Dominant Authority concept of command.

B. Communications:

- All JTF elements are directly connected by integrated networks of secure-voice satellite communications (SATCOM) radios. The JTF has approximately 75 such SATCOM terminals now in operation; aircraft, base, and portable. Secure-voice HF radios provide a back-up.
- Within the SATCOM framework individual units communicate internally using secure-voice VHF-FM and UHF radios. Some 300 of these radios are now in use in the JTF. About 150 non-secure HF, VHF-FM, and VHF-AM radios are also available to control aircraft and to augment other nets.
- JTF Headquarters and the users of the SATCOM and HF radio nets are supported by several base stations which operate in the relay and broadcast modes. These stations are carefully sited to provide redundancy and diversity to reduce potential radio propagation difficulties.

CLASSIFIED BY DIRECTOR, J-3
DECLASSIFY ON 30 OCTOBER 1986

~~SECRET~~ JCS SUMMARY SHEET

J-94

TO: J-33	CLASSIFICATION SECRET	FOR USE BY ORIGINATING DIRECTORATE	
THRU	DJSM NO.	ODJS SUSPENSE DATE	
	DJSM DATE		
SUBJECT: Request for Training Area on Camp Lejeune, N.C. (U)	ACTION		
	APPROVAL	SIGNATURE	INFORMATION
	XX	XX	

REMARKS

(U) The JTD training planned for October requires the use of an urban area for a helicopter assault and infiltration.

(S) Informal liaison has been conducted with the Marine Corps through our POC, [REDACTED] and tentative approval has been granted pending a formal request and site selection.

(U) In compliance with your memorandum* of 10 Sep 80, the request is forwarded for your signature.

(U) Recommend approval and signature.

INCEL
memo dtd 10 Sep 80, "CT/JTF and JTF-79" (S)

DDOT
Classified By: [REDACTED]
Declassified ON: [REDACTED]

COORDINATION/APPROVAL					
OFFICE	NAME	EXTENSION	OFFICE	NAME	EXTENSION
G- JTD	[REDACTED]	55078	COPG	[REDACTED]	
G- SOD	[REDACTED]				

~~SECRET~~



~~SECRET~~
THE JOINT CHIEFS OF STAFF
WASHINGTON, D.C. 20301

THE JOINT STAFF

10 October 1980

MEMORANDUM FOR THE COMMANDANT OF THE MARINE CORPS

Subject: Request for Use of Facilities on
Camp Lejeune, N.C. (U)

1. (U) (S) The Joint Test Directorate, in conjunction with the ongoing test and validation, requests the use of a training area aboard Camp Lejeune, N.C.

2. (U) (S) Desires are to select an urban area on the base complex, into which a helicopter assault and exfiltration would be conducted. The activity would be conducted between 141200-150600 (Local) and 161200-170600 (Local) October 80.

3. (U) (S) Subject to approval, [REDACTED] USA, JTD representative, AUTOVON 236-7636/7512, will visit Camp Lejeune on 13 October. Following site selection/approval it is requested that appropriate maps/photos be provided Captain [REDACTED]

4. (U) No support is required other than assistance during the site survey.

for: Walter J. Jundring Col USA
THOMAS C. WATSON, JR.
Rear Admiral, USN
Deputy Director for Operations
(Current Operations)

PASSED 1510 10 OCT 80

POC: Camp Lejeune

G Col. [REDACTED]

AUTOVON 484-5326/5720

~~SECRET~~



~~SECRET~~ SENSITIVE
THE JOINT CHIEFS OF STAFF
WASHINGTON, D.C. 20301

THE JOINT STAFF

10 September 1980

G MEMORANDUM FOR COLONEL [REDACTED]

Subject: [REDACTED] and JTF-79 (S)

- A
1. (S) In order to begin transition of management from the JTF-79 to [REDACTED] and to further codify and manage the activities of JTF-79, J-30 has directed that more normal staffing procedures should be instituted to meet the requirements of JTF-79. The SOAP status of the OPSDEPS must be implemented in such a way that the OPSDEPS are appraised of plans and requirements of subject operations.
 2. (S) Effective immediately, the requirements for support of subject Joint Task Forces will be processed as follows:
 - a. For those small or minimum cost requirements which have been agreed to by all parties concerned, any necessary paperwork will be processed through SOD for my signature as J-33.
 - b. For those requirements which involve significant funding or commitment of resources and have not been previously agreed, any necessary paperwork will be prepared and staffed for J-3, DJS, CJCS signature after approval at the OPSDEPS level. Any necessary coordination should be completed by SOD.
 3. (S) In order to further assist in the transition, the following actions have been taken:
 - a. LCOL [REDACTED] will be briefed into the JTF-79 activities and plans.
 - b. COL [REDACTED] will be reassigned from JOD to serve as EXEC to JTF-79 until disestablishment about 15 November 1980. At that time, COL [REDACTED] will be reassigned to the SOD [REDACTED] Branch Head. COL [REDACTED] will report as EXEC to JTF-79 on 12 September 1980.
 4. (S) MGEN Vaught has been appraised of the above actions and concurs in this plan.
 5. (S) The sensitive nature of subject operations demands that operational security be preserved. Any of the above actions which unduly risk loss of OPSEC should be referred to me prior to implementation.

THOMAS C. WATSON, JR.

Rear Admiral, USN
Deputy Director for Operations
(Current Operations)

Distribution:

Attached

Distribution:

LTGEN Gast
MGEN Vaught
MGEN Johnson
COL [REDACTED]
LCOL [REDACTED]

G

(THIS PAGE IS UNCLASSIFIED)

~~SECRET~~ ~~SENSITIVE~~

J-75

~~SECRET SENSITIVE~~



THE JOINT CHIEFS OF STAFF
WASHINGTON, D.C. 20301

*404
J-33
See me ple
when can we arrange
conference
Release factors?*

3 October 1980

THE JOINT STAFF

MEMORANDUM FOR THE DIRECTOR, JOINT STAFF

Subject: Special Operations Advisory Panel (U)

1. (U) Reference the memorandum* that established the Special Operations Advisory Panel.
2. (U) Request that the Special Operations Advisory Panel be convened soonest to review the actions taken by JTF 1-79 since the April 1980 rescue attempt. Further request maximum advance notification so that appropriate briefings and orientations can be arranged with minimum disruption of planned activities.
3. (U) Point of contact is Major General Vaught, extension 55814.

James B. Vaught
 JAMES B. VAUGHT
 Major General, USA

Reference:

*Memorandum by the Secretary for the Joint Chiefs of Staff, SM-557-80, 1 October 1980, "Special Operations Advisory Panel (U)"

~~CLASSIFIED BY JCS 13 JTD
DECLASSIFY ON 3 OCTOBER 1986~~

*In FR
G Passed to*



*v 30780
for action.*



~~SECRET SENSITIVE~~

THE JOINT CHIEFS OF STAFF
WASHINGTON, D.C. 20301

SM-557-80
1 October 1980

MEMORANDUM FOR: Chief of Staff, US Army
Chief of Naval Operations
Chief of Staff, US Air Force
Commandant of the Marine Corps
Director, Defense Intelligence Agency

Subject: Special Operations Advisory Panel (U)

1. (U) Purpose. To establish a Special Operations Advisory Panel.
2. (U) Background. Following the April 1980 hostage rescue attempt, a special operations review group was appointed and tasked with performing an independent appraisal of the rescue mission. One of that group's recommendations was the establishment of a Special Operations Advisory Panel comprised of high-ranking officers (active and/or retired) who would have the function of assessing highly classified special operations for the Joint Chiefs of Staff. The Joint Chiefs of Staff concurred in that recommendation, and the Secretary of Defense has approved the establishment of the Special Operations Advisory Panel.
3. (U) Implementation
 - a. (U) (C) The Operations Deputies will continue to provide, on a permanent basis, a review of special operations planning for the Joint Chiefs of Staff.
 - b. (U) In addition, a Special Operations Advisory Panel is established and will perform functions as set forth in the terms of reference in the Appendix.
 - c. (U) (C) The Chief of each Service and the Director, Defense Intelligence Agency, may nominate members of the Special Operations Advisory Panel, and the Joint Chiefs of Staff will approve each appointment.

Copy 8 of 9 Copies each
of 2 pages each -X-

~~CLASSIFIED BY DJS~~
~~REVIEW ON 15 SEPTEMBER 1986~~
~~EXTENDED BY DJS~~
~~REASON: 5200-1R, PARA 2.301c5c6~~

~~SECRET SENSITIVE~~

~~SECRET SENSITIVE~~

4. (S) Operations Security. The functions of the Operations Deputies and the Special Operations Advisory Panel are extremely sensitive. Addressees will treat the information in this memorandum accordingly and limit access to only personnel with a verified need to know.

For the Joint Chiefs of Staff:



9

Colonel, USAF
Secretary

Attachment

~~SECRET SENSITIVE~~

- c. (U) (S) The Panel will be granted access to all pertinent documentation. Briefings and discussions with appropriate individuals will be arranged as necessary. 1
2
- d. (U) (S) When special operations planning is initiated in response to a crisis, several members of the Panel may be convened to provide an independent assessment and advice. Panel members will not participate in the actual planning. 3
4
5
6
- e. (U) (S) Panel assessment of special operations should include, but not be limited to, the following areas: 7
8
9
 - (1) (U) (S) Operational criteria and guidance. 10
 - (2) (U) (S) Force organization. 11
 - (3) (U) (S) Training. 12
 - (4) (U) (S) Operational capabilities. 13
 - (5) (U) (S) Support from Services and other agencies. 14
 - (6) (U) (S) Command and Control. 15
- 5. (U) Reporting. The Panel will report findings and recommendations to the Joint Chiefs of Staff. 16
17
- 6. (U) Support. The Director for Operations, OJCS, will assure access to necessary documentation, briefings, and personnel. He will also arrange for necessary administrative and technical support in accordance with applicable laws and directives. 18
19
20
21
22

TERMS OF REFERENCE FOR THE
SPECIAL OPERATIONS ADVISORY PANEL (U)

- 1. (U) Purpose. To conduct an independent assessment of specified highly classified special operations to provide advice to the Joint Chiefs of Staff. 1
2
3
4
5
- 2. (U) Composition. The Special Operations Advisory Panel will consist of a group of at least five carefully selected high-ranking officers (active and/or retired) who have career backgrounds in special operations or who have served at Service, CINC, or OJCS staff levels and who have maintained a current interest in special operations or defense policy matters. The Panel will consist of a chairman and members appointed to fixed terms, not to exceed three years. Members of the Panel will maintain current security clearances and meet at least annually for update briefings. 6
7
8
9
10
11
12
13
14
15
- 3. (U) Scope. The assessment function performed by the Special Operations Advisory Panel should address the following aspects of special operations: 16
17
18
 - a. (U) Operational concepts and capabilities. 19
 - b. (U) Operational security constraints and options available. 20
21
 - c. (U) Adequacy of resources, preparation, and support. 22
- 4. (U) Guidelines 23
 - a. (U) The Special Operations Advisory Panel will meet at the call of the Joint Chiefs of Staff. 24
25
 - b. (U) The functions of the Panel will be in addition to those that will be performed by the Operations Deputies in their review of special operations planning. 26
27
28

~~CLASSIFIED BY D33
REVIEW ON 15 SEPTEMBER 1986
EXTENDED BY D33
REASON: 5200.1R, PARA 2.301c5&6~~

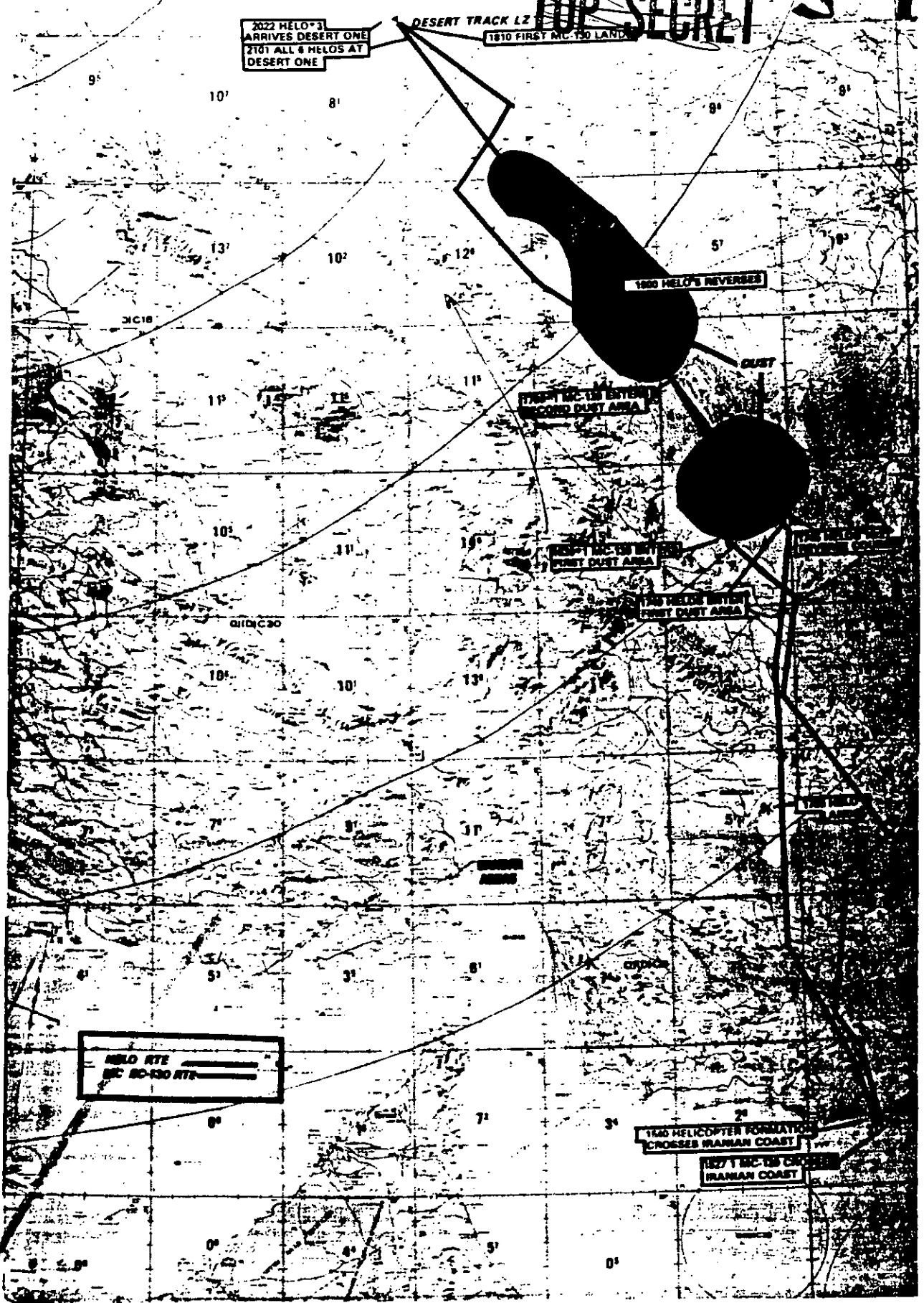

13 May 1980

152931

72878

TOP SECRET

RESCUE MISSION

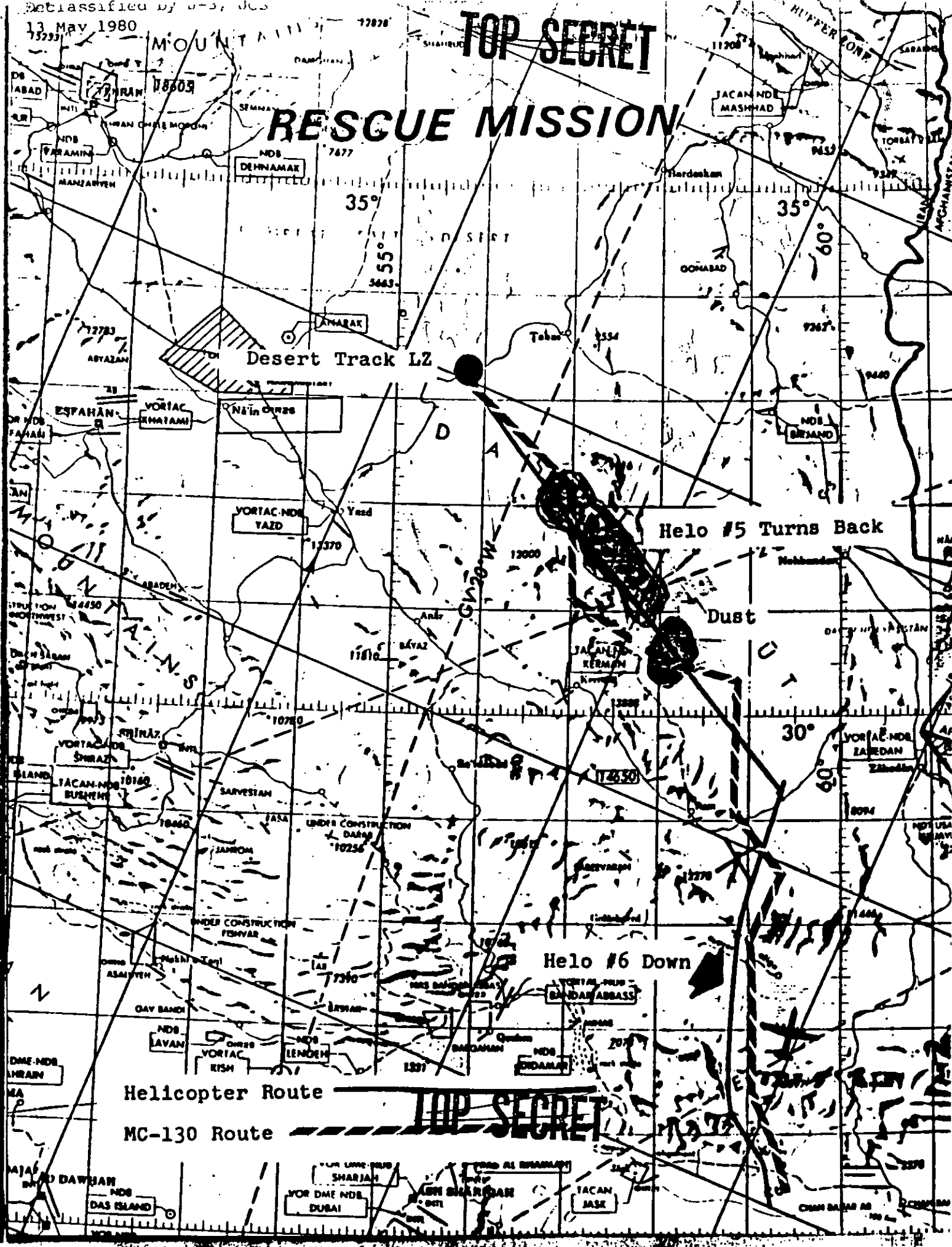

Desert Track LZ

Helo #5 Turns Back

Dust

Helo #6 Down

Helicopter Route

MC-130 Route

TOP SECRET



DEPARTMENT OF THE NAVY
HEADQUARTERS UNITED STATES MARINE CORPS
WASHINGTON, D.C. 20380

J-101

IN REPLY REFER TO

CCTS-613-dla
3 SEP 1980

~~CONFIDENTIAL~~

From: Commandant of the Marine Corps
To: Joint Test Director, J-3, Joint Staff

Subj: Honey Badger Support Requirements (U)

Ref: (a) Joint Test Director memo to CMC dtd 25 Jul 1980

1. (U) The reference requested the temporary loan of twelve AN/WSC-3 radios. The AN/WSC-3 radios earmarked for the USMC are being installed in the Satellite Communications Central, AN/TSC-96. The AN/TSC-96 is scheduled to replace the obsolete and no longer supportable HF Central, AN/TSC-15. Fielding is to commence in December 1980. The AN/TSC-96 will provide the major long-haul communications for the Marine Amphibious Forces and there are no spares, maintenance float, or war reserve in the program. To provide any AN/WSC-3 radios on temporary loan would have serious impact on the long-haul communications readiness of USMC forces.
3. (U) Accordingly, the temporary loan of twelve AN/WSC-3 radios cannot be accommodated.

K. McLennan

K. MCLENNAN
Assistant Commandant of the Marine Corps
and Chief of Staff

Classified by J-3
Declassify on 31 July 1986

~~CONFIDENTIAL~~

*Declassified by
DDO NMCC
4 Aug 92*



~~TOP SECRET~~

THE JOINT CHIEFS OF STAFF
WASHINGTON, D.C. 20301

J-102

24 June 1980

THE JOINT STAFF

MEMORANDUM FOR LIEUTENANT GENERAL PUSTAY

Subject: Hostage Rescue Mission (Operation SNOWBIRD)

1. (U) Summary. Due to the lack of definitive intelligence, adequate force proficiency and available launch bases, development of a specific operational plan to rescue the American hostages held in Iran is not possible at this time. Force proficiency is expected to be realized by 15 July. Action is ongoing to produce an adequate intelligence base and some effort is being made to assure the availability of staging facilities near enough to Iran to enable the secure launch and recovery of the rescue force.

B, C, (S) 2. Intelligence. [REDACTED] since the aborted rescue attempt. Eleven Service and retired Service members have been screened, selected and have volunteered to perform intelligence tasks in Iran. Several innovative technological approaches to improve intelligence gathering are being pursued. Despite the possible near-term future release of some of the hostages, it is expected that others will experience protracted detention and possibly trial.

A, E 3. Launch Bases. It is essential to at least obtain an indication that one or more of Iran's neighbors would ignore our use of its soil for a rescue mission. No such indication is in hand. A survey is being made with a view towards the possible use of [REDACTED]. Additionally, efforts are underway to gain access to Iran for JTF elements via an overland route using a [REDACTED]

A 4. [REDACTED]

[REDACTED]

CLASSIFICATION REVIEW EO 12356
 CONDUCTED ON 4 Aug 92
 DERIVATIVE OF BY DDO/mcc
 REL UNCLASSIFIED Secret
 REVIEWED BY QAR
 DERIVED FROM Multiple Sources

~~TOP SECRET~~

5. (U) Force Selection. The ground element of the previous task force has been retained. The C-130s, MC-130s, AC-130s, and EC-130s remain with the force. The helicopter air element has been revised and expanded. A newly available Air Force helicopter unit with improved capabilities has replaced the Navy-USMC helicopter force. Additionally, a newly available Army helicopter unit is being trained for possible inclusion in the JTF force structure.

6. (TS) Training. The lack of definitive intelligence has forced the JTF to produce a variety of concept plans (see TAB B) as opposed to a precise operational plan. The attainment of several capabilities is being pursued so we can quickly adapt a selected, trained force to a set of known circumstances ~~_____~~ when those circumstances become known to the JTF. By mid-July, a trained and adaptable rescue force should be available.

B, C

7. (U) Costs. Due to the expanded force and protracted training, SNOWBIRD costs are somewhat larger than those associated with the previous organization. Problems are being experienced by the Services in identifying sufficient funds for several categories of expenditures. By mid-July, costs incurred should total approximately 26 million dollars. Approximately two thirds of these expenditures would occur in any event to support routine programmed activities although they would be incurred over a more protracted period.

JAMES B. VAUGHT
Major General, USA
JTF Commander

~~(C)~~ Attachments

- A - Intelligence
- B - Plans
- C - Launch Bases
- D - ~~_____~~
- E - Force Selection
- F - Training
- G - Costs

A

SNOWBIRD INTELLIGENCE

1. (TS) Problems. As a result of the aborted rescue attempt of 24 April, [REDACTED]

C (S)

[REDACTED] protective actions by Iranian authorities and the militants, as well as a presumed intensification of Iranian and third party counterintelligence efforts.

2. (TS) Assets. In early May, the only substantial productive intelligence assets were [REDACTED]

B, C

On 14 May, the Chairman, Joint Chiefs of Staff [REDACTED]

C (S)

3. (TS/CW) Actions. The JTF has initiated a number of actions to produce useful intelligence. These are summarized below:

a. (TS/CW) The JTF in cooperation with [REDACTED] USAINSCOM and [REDACTED] pursuing a number of technological actions.

First, it is believed that an [REDACTED]

[REDACTED] It is hoped that this capability will be available by 14 July.

b. (TS/CW) [REDACTED] This effort is planned to begin on a coordinated basis in early July.

c. (TS) When it was learned that the Iranians were blocking airfields which could be used in a rescue attempt, the JTF initiated action to investigate the feasibility of [REDACTED] to define obstructions. If found to be feasible, a mission on Iran would be planned to occur after 14 July.

d. [REDACTED] in SNOWBIRD, the JTF initiated a personnel search of [REDACTED]

[REDACTED] This effort is continuing.

~~SECRET~~
4. (TS) Forecast: Although [REDACTED]

B, C
we believe the situation is entering a new phase in which we may see release of some hostages within the next 30 days. However, we do not see the release of all or even a majority of the hostages prior to the first anniversary of the Embassy take over. Of continuing concern is the possibility that the hostages' lives could be put at risk if Khomeini were to die unexpectedly, an assassination was alleged, or if one of the exile groups initiated armed dissident activity in the capital which was viewed by the militants and the clerics as a major threat to their control of the situation. Recognizing these possibilities, it is absolutely essential that a maximum effort [REDACTED]

[REDACTED] continue.

SNOWBIRD PLANS

(U) 1. ~~(TS)~~ Problems. After the aborted rescue attempt of 24 April, the JTF lost a number of capabilities and assets that impacted heavily on planning. This was primarily due to the compromise of in-country operational facilities such as the hiding site for helicopters, some air extraction facilities, the warehouse and the ground transportation assets. Therefore, plans for different operational facilities had to be made. Additionally, the possible relocation of some of the hostages and defensive measures taken by the Iranians caused the Task Force to consider several wholly new situations.

B
AC
2. ~~(TS)~~ Assets. Approximately one-half of the former planning staff was retained and additional officers providing more diversified talent were newly assigned. Some deletions and additions to the planning forces were made. The largest single constraint faced by the planners was [REDACTED]

Therefore, concept plans, as opposed to operational plans, were produced. Delta, the rescue force, would be inserted by infiltration under each concept.

AE
3. ~~(TS)~~ Actions. The first concept plan, SNOWBIRD I, envisions the use of Air Force combat rescue helicopters and fixed-wing aircraft from the Special Operations Wing supporting the extraction of Delta and the hostages from the hostage holding sites. Launch bases for this option were assumed to be available in [REDACTED] and [REDACTED]. The insertion of the Delta force was planned through an overland route using the [REDACTED] from [REDACTED] or elsewhere.

SNOWBIRD II uses a launch facility in [REDACTED] with the same force.

AE
SNOWBIRD III launches from facilities in [REDACTED] with the Delta force still utilizing overland transportation from [REDACTED]

E
SNOWBIRD IV envisions a short warning scenario where it would be necessary to hurry a force to [REDACTED] or [REDACTED] in the event the hostages were suddenly placed in grave jeopardy.

SNOWBIRD V envisions a no-warning situation. This concept would have to be accomplished by the use of military vehicles being driven to the hostage holding site after a nearby air facility was seized by overt military force. As of this date, type vehicles have not been specifically identified or procured.

SNOWBIRD VI envisions the use of both [redacted] and [redacted] bases. However, in this concept, the use of Army CH-47 helicopters is planned to establish several way stations in remote areas of Iran facilitating the extraction phase. This concept provides a maximum degree of redundancy.

E

SNOWBIRD VII is a concept for the use of [redacted] newly available Army UH-60 Black Hawk helicopters into Iran. It is possible for the helicopters to carry the Delta force directly into the hostage holding sites, however, this aspect would be heavily influenced by specific intelligence.

A

SNOWBIRD VIII envisions the same type of action as SNOWBIRD VII with the difference that a US Navy helicopter launch platform would be utilized.

SNOWBIRD IX involves the seizure of Mehrabad by an air-landed force simultaneously with the insertion of [redacted] in the hostage holding sites. There would be approximately twenty small, [redacted] rapidly available to transport the hostages to the airfield. This concept rests on a proven test of quick unloading and operation of numerous [redacted]. It also minimizes the reliance on Iran's neighbors to offer staging bases since the airfield seizure and helicopter transport, introduced via long range refuelable transport aircraft, could originate from either [redacted] or [redacted].

A, E

Additionally, the JTF is pursuing a concept that would rely as much as possible on ground transportation and infiltration by [redacted] in order to avoid the use of helicopters.

A

4. (PS) Forecast. Without [redacted] an operational plan that promises a reasonable degree of success is not possible. However, forces can be prepared in accordance with the above concepts so that when sound intelligence is obtained, an executable plan will quickly become possible.

B, C

SNOWBIRD LAUNCH BASES

1. ~~(S)~~ Problems. The 24 April attempt uncovered the use of [redacted] and [redacted]. The JTF has no authority to use foreign soil and the shortened periods of darkness during the Summer months requires the use of launch facilities close enough to the hostage locations to enable rescue completion during the dark hours of a single night.

E

2. ~~(S)~~ Assets. From a diplomatic and security standpoint, it is believed that the JTF can still use [redacted]. Although the risk is higher than in April, we believe a carefully staged and [redacted] of forces at [redacted] has a good chance of escaping Soviet detection. Previous experience indicates that Iranian intelligence may not have an ability to monitor [redacted]. Currently, this is the only facility that the JTF could count on as a launch base asset.

A, E

3. ~~(S)~~ Actions. A survey is being made by the JTF to determine the feasibility of using [redacted] and [redacted] for the insertion of both [redacted] and the rescue force into Iran. No formal contacts are contemplated in either country at this time.

C, E

The JTF has also taken action to insure that [redacted] is ready to accept the rescue force in a short notice or emergency situation. The European Command (EUCOM) has been tasked to provide an adequate base structure at [redacted] within 72 hours of notification. A detailed list of requirements has been forwarded to EUCOM.

E

CJCS has requested the Secretary of Defense to contact [redacted] officials, if it is opportune, at Geneva during his visit on 26 and 27 June concerning the possible use of [redacted].

E

The JTF has also received support [redacted]

C, E

4. ~~(S)~~ Forecast. With the exception of [redacted] it is not possible for the JTF to determine the extent of assistance that any regional nation would give to a rescue force. However, it may be possible to obtain a tacit understanding from one or more of Iran's neighbors to "look the other way" if a rescue force used some remote sites. At the end of the month, it is expected that a more definitive knowledge of launch base possibilities will be known. By mid-July, it is expected that a realistic, clandestine ground transport scheme will be under development.

E

~~TOP SECRET~~
A/S SNOWBIRD [REDACTED]

1. ^(U)~~(S)~~ Problems. The extensive publication of details concerning the 24 April rescue attempt uncovered some of the JTF forces. Additionally, some launch facilities were compromised. Furthermore, some individuals within the JTF became known and associated with rescue operations. To attempt the same method of operation that was used from Nov 1979 until April 1980 could certainly flag development of a subsequent rescue operation.

2. ^(S)~~(S)~~ Assets. Training and rehearsal for the first rescue attempt was conducted largely in the southwest region of the United States. Therefore, the northwestern region which has similar summertime climatology conditions to Iran was selected for SNOWBIRD training.

It was considered that joint training exercises would not provide adequate [REDACTED] for the training and rehearsal of the JTF.

A

[REDACTED]

3. ^(S)~~(S)~~ Actions. On 23 May, Defense Research and Engineering provided assistance to the JTF by creating a Joint Test Director's office. The stated mission of the office is to test special equipment under Middle East type conditions.

A

[REDACTED]

A

[REDACTED]

In the previous rescue attempt, some 200 personnel were formally briefed on the operation. It was estimated however, that approximately 1200 personnel had at least partial knowledge of the operation prior to its execution. Currently, some 300 personnel are knowledgeable of SNOWBIRD. It is believed that approximately 1500 persons have at least partial knowledge of the actual purpose. Thus far, there is no known disabling compromise of SNOWBIRD.

~~TOP SECRET~~
4. (TS) Forecast. Should an execution order be given for SNOWBIRD, it is planned that the JTF deploy to the Persian Gulf region [REDACTED]

A [REDACTED] it is also planned to actually provide the results of innovative equipment techniques and operational procedures to the Office of Defense Research and Engineering for dissemination to the Services. [REDACTED]

[REDACTED] It is also believed that despite the unusual and open conditions under which the JTF is now operating, SNOWBIRD has a good chance of execution without disabling compromise. This, of course, assumes a sound operational security situation in the as yet unidentified launch bases.

A [REDACTED] the rescue of our citizens being held in Iran.

~~TOP SECRET~~

SNOWBIRD FORCE SELECTION

B, C
1. (S) Problems. Without definitive intelligence [redacted] a wider spectrum of forces had to be prepared than was the case in the April rescue attempt.

A
2. (S) Assets. Since the Rangers were not identified in the disclosure of information after the first rescue attempt, their organization, [redacted] Rangers was immediately selected for a future attempt. The Delta force was also identified since it is the most competent organization to effect the close-in release of hostages. Additionally, the fixed wing penetration aircraft AC, EC, and MC-130s with the 1st Special Operations Wing were also needed in any future effort.

Since the Navy helicopter force had been destroyed in Iran, and because a new Air Force unit became available during the month of April, a force structure change was made. It was decided to replace the Navy helicopter capability, with the new Air Force element which has an improved capability for penetration, night navigation, and extended range flights.

A
Another new helicopter element became available when the 101st Airborne Division completed the acquisition of a substantial number of UH-60 Black Hawk helicopters. This force, if equipped with extended range fuel tanks, offered the possibility of an [redacted] flight with a maneuverable, relatively quiet helicopter, one capable of landing in restricted, obstructed areas.

A
3. (S) Actions. The JTF began immediate action to include the new Air Force helicopter unit within the organization of the Special Operations Wing to facilitate control, training and operational security. This action has been substantially achieved. The JTF then began efforts to examine the possibility of launching the Army Black Hawk helicopters [redacted]

A
The JTF is also considering the use of [redacted] transported helicopters which would be used to fly short distances to support the hostage release in the hopes that those elements would not be plagued with the maintenance problems associated with heavier helicopters. Initial experiments of rapid off-loading have been conducted. No specific unit, however, has been formed for this task.

A
4. (U) Forecast. While the JTF has investigated the use of a wide spectrum of forces, a changing intelligence picture could provoke the JTF to select new, previously unidentified units.

SNOWBIRD TRAINING

BC
1. ~~(S)~~ Problems. Without an approved operational plan, and [REDACTED] a targeted training program cannot be developed. However, it is possible to develop unit capabilities which are likely to be needed in any future rescue attempt in Iran.

A
2. ~~(S)~~ Assets. Training and rehearsal areas in Utah, northern Nevada and New Mexico have been selected. Available intelligence, such as an estimate of the [REDACTED] is being used in specific training scenarios. Personnel who had experience in the previous operation are being used to instruct newly assigned units in hazardous tasks such as night navigation during low level penetration missions.

3. ~~(S)~~ Actions. The JTF has identified long leadtime training requirements that would probably be used in a rescue attempt. These include: extended range, night flights, rapid assembly of helicopters after air transport and night air refueling operations. Efforts have been ongoing since mid-May to acquire effectiveness in these and other skills which would be required in any future rescue attempt.

A
On 9 June, thirty Black Hawk helicopters of the 101st Airborne Division were deployed to Norton AFB, California for night desert training. On 14 June, the newly available Air Force combat rescue helicopters began deployment to White Sands, New Mexico for similar training. New [REDACTED] have been developed by the Ranger force as well as rapid off-loading and operation of [REDACTED] helicopters.

The above component training should be completed by 3 July. At that time, joint training by Task Force elements will begin. The focus of the joint training will occur at the Dugway Proving Ground in Utah. Flight profiles will be made into northern Nevada. This training will closely approximate the actual climate and terrain conditions expected to be encountered in Iran. It will also feature formation flying allowing the Black Hawk force to be led to an objective by the Air Force combat rescue element utilizing terrain avoidance radar and night vision equipment.

4. ~~(S)~~ Forecast. The development of force proficiency against known, probable requirements should produce a force ready to begin specific rescue rehearsals once definitive intelligence is obtained. Gross capabilities for the rescue force are expected to be obtained by 15 July.

~~TOP SECRET~~

SNOWBIRD COSTS

1. (S) Problems. In the absence of definitive intelligence, a wide spectrum of forces had to be identified, exercised and enhanced in order to provide a minimum contingency capability. SNOWBIRD costs are larger than those associated with the previous rescue attempt. Since these costs are unprogrammed and are occurring near the end of the fiscal year, problems are being encountered in procuring essential equipment and conducting the necessary training. Additionally, force proficiency, primarily within the helicopter elements, is requiring a more protracted, costly training program than was originally envisioned.

2. (S) Assets. Other than \$50,000 allocated by Defense Research and Engineering for travel funds for the JTF staff, no funds are directly controlled by the JTF. [REDACTED]

[REDACTED] The vast majority of all JTF funding has to be provided by reallocation of current Service resources. About two thirds of the expenditures associated with SNOWBIRD represent costs that would have been incurred in any event. However, these expenditures are being incurred sooner than originally programmed.

3. (S) Actions. Following the aborted 24 April rescue attempt, the JTF asked for an accounting [REDACTED]

As of this date, the accounting is not completed. [REDACTED]

[REDACTED] The Secretary of Defense has been advised [REDACTED]

On 6 June, the Chiefs of Staff of the Army and Air Force were informed that each Service would have to identify approximately 12.5 million dollars to support the operation. These figures were derived from the experience gained during the previous rescue attempt.

On the 19th of June, both the Air Force and Army staffs indicated problems in the ability to monitor and reallocate funding to support the operation. It is not known at this time if sufficient funds actually exist to support SNOWBIRD. Although enough funds may exist in gross terms, specific funding programs which are tightly proscribed by Congressional ceilings, such as travel funds, may be inadequate for SNOWBIRD requirements.

4. ^(U)~~(S)~~ Forecast. SNOWBIRD funding, an unprogrammed, constantly changing activity will continue to present major problems within the Department of Defense. The resolution of each problem requires contact with additional, previously unknowledgeable people who should not be made aware of the actual intent of the operation. In short, the "need to know" security rule must be broken to obtain funds from administrators who could unwittingly uncover the "SNOWBIRD" operation. By mid-July, a total of 25 million dollars will probably be expended for SNOWBIRD activities.



THE JOINT STAFF

~~SECRET~~ 22 Aug 80
e13
The Operations Officer
DJSJ-1650-80
22 August 1980

J-103

MEMORANDUM FOR THE DIRECTOR FOR OPERATIONS

Subject: Study to Improve US Special Operations Capability (U)

- (U) 1. [redacted] The recent rescue mission and subsequent reports have illuminated the need to improve the US capability for special operations. J-3, with the assistance of COMJTF 1-79 and the recently approved CTJTF, should identify the actions necessary to expand and improve US Armed Forces' capabilities to conduct special operations. This report should include, inter alia, a review of the force, organizational, and training aspects of the Holloway and Gast reports. It is envisioned that this will be a joint action worked in close coordination with the Services through points of contact identified by the Service Operations Deputy.
- 2. (U) The Operations Deputies request that an interim report be submitted by 15 October 1980 and a final report by 15 December 1980.

Thor Hanson

THOR HANSON
Vice Admiral, USN
Director, Joint Staff

Copies furnished:
LtGen Schwenk
LTG Otis
VADM Foley
Lt Gen O'Malley
Director, J-5
MG Vaught

CLASSIFIED BY DJS
REVIEW ON 22 AUG 86

Copy 7 of 9 copies

Declassified by
DDO/mcc
4 Aug 9

~~SECRET~~

25 Aug 80

~~TOP SECRET~~ C/S ~~at~~
THE JOINT CHIEFS OF STAFF
WASHINGTON, D.C. 20301



DJSM-1647-80
22 August 1980

J- (104) ✓

THE JOINT STAFF

MEMORANDUM FOR MAJOR GENERAL VAUGHT

Subject: Site Survey Team (U)

E

1. ~~(S)~~ Your request in the briefing of 5 August 1980 to the Operations Deputies for authority to approach the [redacted] regarding dispatch of a three-man JTF site survey team to northeast [redacted] is denied. The Operations Deputies do not believe that any discussion with [redacted] officials is advisable or warranted for the conduct of a site survey. It is understood, however, that such contact may be necessary should a decision be made to use any Saudi facilities. It is anticipated that such contact would be at a level well above the JTF.

A, E

2. ~~(S)~~ As an alternative, the JTF is to develop a plan with J-3 to conduct a site survey under the [redacted]

Thor Hanson

THOR HANSON
Vice Admiral, USN
Director, Joint Staff

Copies furnished:
LtGen Schwenk
LTG Otis
VADM Foley
Lt Gen O'Malley

CLASSIFIED BY DJIS
REVIEW ON 22 AUG 86

Copy 1 of 7 copies

*Classified by DDO NMCC
4 Aug 92
Declassify on: OADR*

~~TOP SECRET~~ Downgraded to Secret
DDO NMCC



~~TOP SECRET~~

THE JOINT CHIEFS OF STAFF
WASHINGTON, D.C. 20301

J-107

THE JOINT STAFF

3 September 1980

MEMORANDUM FOR: Deputy Chief of Staff, Operations, Plans and
Readiness, United States Air Force
Vice Director, Joint Staff, Organization of
the Joint Chiefs of Staff

Subject: Alternate to the Fulton Recovery System (U)

1. (U) (S) During the 27 August 1980 OPSDEPS meeting, the subject of the alternative to the Fulton Recovery System was raised. It was stated that the testing of this system could have a significant negative impact on the satellite recovery program. The point was made that this is an example of low level, JTF staff officers, "back dooring" requirements without approval.
2. (U) (TS) This perception of JTF operating methods needs to be corrected. The project is a legitimate requirement which was identified in late April when we found that we had personnel "in-country" and were lacking a suitable option for aerial extraction. With my approval, this R&D requirement was forwarded to the Office of the Secretary of Defense. BDM Corporation prepared a study which was reviewed on 25 July by members of my staff and Dr. LaBerge's office. All agreed that an existing hot air balloon system coupled to satellite recovery techniques warranted further investigation. The initial phase of the testing begins on 3 Sep in Albuquerque and will involve delivery and deployability testing. Four NCOs will participate with BDM personnel during this phase.
3. (U) (S) It was always understood by JTF and OSD action officers that when and if aircraft recovery testing was required, it would occur at the convenience of the recovery unit. If this required going to Hawaii, this was quite acceptable to the JTF. No JTF personnel were involved in arranging a recovery test schedule. On 28 Aug I learned that the OSD project officer did authorize BDM project officer to discuss possible participation in this project with Mr. Hass, Deputy Under Secretary of the Air Force for Space Systems. No schedule has been agreed on. However, the BDM project officer was well aware that this project is secondary to recovery unit activities.

CLASSIFIED BY JCS, J-3
REVIEW ON 3 SEPTEMBER 2000

Declassified by
DDO NMC
141154

Copy No. 3 of 3 Copies

~~TOP SECRET~~

4. ^(U)~~(TS)~~ While this investigation was initiated prior to the OPSDEP's briefing on Project SNOWBIRD ~~(TS)~~, it was mentioned as an ongoing project when they received their 6 August 1980 briefing. Subsequent to that, a memo updating AF/XO was provided on 22 August 1980. This project was also briefed to AF/RD during his initial SNOWBIRD ~~(TS)~~ briefing on 23 Aug 80.

5. (U) In summary, this project now nicknamed NITE FITE, is a legitimate effort to seek a near term solution to an existing operational requirement. Testing, as planned, would have no impact on the satellite recovery program.

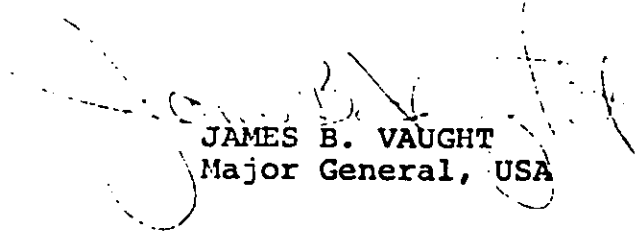
JAMES B. VAUGHT
Major General, USA

J-10

THE JOINT CHIEFS OF STAFF

~~TOP SECRET~~

MEMORANDUM

Date 4 Sep 80

To: Nemo for Record

Subject: Alternate to the Fulton Recovery Sy

Cy 1 to Dep Chief of Staff Ops Plans
& Readiness, Gen O'Malley

Cy 2 to Vice Director, Gen Dyke

Cy 3 to LTC Neff - File

KCK

~~TOP SECRET~~



~~SECRET~~
DEPARTMENT OF THE NAVY
OFFICE OF THE CHIEF OF NAVAL OPERATIONS
WASHINGTON, D.C. 20350

~~SECRET~~
SENSITIVE

J 65
~~SECRET~~

IN REPLY REFER TO
17 December 1980

SECRET - SENSITIVE

MEMORANDUM FOR THE VICE CHIEF OF NAVAL OPERATIONS

Subj: U.S. Navy Planning Support (U)

Ref: (a) VCNO memo to MG Vaught of 30 June 1980
(b) JCS 131457Z DEC 80

- 1. ~~(S)~~ By reference (a), you designated me to provide full-time Navy participation on General Vaught's JTF-79 staff. Reference (b) transferred JTF-79 mission responsibilities to [REDACTED]
- 2. ~~(S)~~ In preparation for the above mentioned transfer of mission responsibility, I have personally debriefed Navy planning functions and procedures with the Chief of Staff, [REDACTED] the Director of the Operations Directorate of the Joint Chiefs of Staff; and Deputy, CINCLANTFLT. In order to ensure that [REDACTED] will have ready access to Navy planners with extensive TF/TG expertise, CINCLANTFLT will be designated by CNO to provide staff support for [REDACTED] planning, exercises, and operations.
- 3. ~~(S)~~ I have provided turnover packages containing exercise plans, frag orders, and after-action (lessons learned) reports to each of the three staffs [REDACTED] JCS, CINCLANTFLT).
- 4. ~~(S)~~ Unless otherwise directed, I will terminate my duties to JTF-79 as soon as CINCLANTFLT indicates they are ready to support [REDACTED] planning. Anticipate CINCLANTFLT response by 24 December 1980.

Very respectfully,

W. A. Gureck
W. A. GURECK

Rear Admiral, U.S. Navy

~~(S)~~ Copy to:
LTG Gast
MG Vaught
[REDACTED]

CLASSIFIED BY CNO (OP-094)
REVIEW ON 17 DECEMBER 1986

~~SECRET~~
~~SECRET~~
~~SECRET~~
SENSITIVE

~~SECRET~~

Classified by
D.D. NMCC 4 Aug 92
Declassify on OADR



~~TOP SECRET~~
THE JOINT CHIEFS OF STAFF
WASHINGTON, D.C. 20301

17 December 1980

THE JOINT STAFF

MEMORANDUM FOR DISTRIBUTION

Subject: JTD-79 Naval Planning Material

The enclosed material is forwarded for your information and retention.

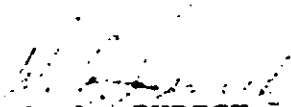
W. A. GURECK

Enclosures: 1

SENTINEL SWORD After Action Report
POISON DART After Action Report
STORM CLOUD Frag Order

Distribution:

~~(S)~~ JCS, J-3
Deputy CINCLANTFLT

A

When enclosures are removed,
this memorandum is downgraded
to UNCLASSIFIED.

~~TOP SECRET~~

CLASSIFIED BY JCS, J-3, JTD
REVIEW ON 17 DECEMBER 2000

~~TOP SECRET~~
THE JOINT CHIEFS OF STAFF
WASHINGTON, D.C. 20301

5 SEP 1980



THE JOINT STAFF

MEMORANDUM FOR DISTRIBUTION

Subject: Sentinel Sword After Action Report (U)

Sentinel Sword After Action Report is forwarded for your information.

W. A. GURECK
Rear Admiral, USN

Enclosure
a/s

Distribution:

G Joint Test Directorate
CINCPAC (Capt )

When Enclosure is removed
this Memorandum is Downgraded
to UNCLASSIFIED

~~TOP SECRET~~

AFTER ACTION REPORT ON EXERCISE SENTINEL SWORD (S)(U)

1. (S)(U) Purpose: SENTINEL SWORD was conducted on 12 and 13 August 1980 to exercise Air Force E-3A AWACs and Navy F-14/A-6 coordination procedures in aggressor suppression and airfield interdiction methods.
2. (S)(U) Objectives: The exercise objectives were:
 - a. (S)(U) Evaluate F-14/E-3A mission effectiveness inside and outside E-3A radar range.
 - b. (S)(U) Evaluate E-3A to F-14 one way Link 4A procedures and secure communications interface at extended ranges.
 - c. (S)(U) Establish/refine airfield neutralization techniques.
 - d. (S)(U) Establish/refine procedures to use IFF to best advantage assuming simulated enemy is equipped with Western aircraft.
 - e. (S)(U) Evaluate mission rollback/egress procedures.
 - f. (S)(U) Evaluate capabilities to conduct mission at extended ranges from F-14 simulated aircraft carrier launch position and E-3A simulated staging base.
 - g. (S)(U) Evaluate F-14/A-6 crew capability to sustain long duration mission.
 - h. (U) Install and evaluate the effectiveness of E-3A airborne satellite secure voice (WSC-3).
3. (S)(U) SENTINEL SWORD Participants. The following units participated on each night of the exercise:
 - a. 552 AWACW provided one primary and one backup E-3A out of Tinker AFB.
 - b. 474 TFW provided four F-4D sorties for aggressor tracks from Nellis AFB.
 - c. COMFITAEWINGPAC provided four F-14 for CAP operations and four F-4 aircraft for aggressor operations out of NAS Miramar.
 - d. COMMATVAQWINGPAC provided two A-6E and three KA-6D (first day only) staging out of NAS Miramar.
 - e. HQ SAC (DOB) provided KC-135 support.
 - f. NMTC Point Mugu provided exercise support.
 - g. J3-SOD directed the overall conduct of the exercise.

h. The Joint Support Communications Element (JCSE) provided ground and airborne secure voice terminals and operators.

4. ^(U)~~(S)~~ Concept of Operations The exercise concept was to:

a. ^(U)~~(S)~~ Provide E-3A command and control to F-14 and A-6 in fighter suppression and airfield neutralization roles. (See map at Attachment 1).

b. ^(U)~~(S)~~ Operate four F-14 CAP aircraft and two A-6 attack aircraft on stations as follows:

(1) Two F-14s (air-to-air configured) on station 950nm from simulated carrier for two hours.

(2) One F-14 (air-to-air configured) on station 740nm from simulated carrier for 3.5 hours.

(3) One F-14 (air-to-air configured) and two A-6 (air-to-ground configured), on station 540nm from simulated carrier for four hours.

c. ^(U)~~(S)~~ Provide KC-135 support to refuel all mission aircraft as required to meet on station criteria. All tactical aircraft to be maintained with combat package fuel load.

5. ^(U)~~(S)~~ Planning. Planning for SENTINEL SWORD commenced in July 1980. A plan was devised to provide F-14 CAP support for contingency/rapid reaction capabilities (Attachment 2). A planning conference was held at Tinker AFB on 6 August to brief aircrew participants on the exercise scenario and to refine the plan (see Attachment 3 for list of attendees). The FRAG order was drafted by 552 AWACW for SENTINEL SWORD and promulgated on 9 August by JCS/J3-SOD (Attachment 4).

6. ^(U)~~(S)~~ Exercise Narrative. The concept was exercised twice during the night of 12 and 13 August. Four F-14, two A-6E, one E-3A (with airborne backup) were exercised each night. KA-6D tankers exercised only on the first night and provided one on-station refueling for CAP A and B. KC-135's provided en route refueling to all aircraft on both nights and to CAP stations A, B and C. F-14/A-6 tracks to station were constructed to simulate CAP stations at extended range from the carrier. E-3A provided command and control in accordance with the exercise plan.

7. ^(U)~~(S)~~ Results:

a. E-3A operations

(1) Aircraft reliability was outstanding. All primary mission aircraft and backups were full mission capable (FMC).

- (2) Radar coverage was adequate from E-3A orbit to the most distant CAP station (radar tracking was accomplished at 405 nm). All aggressor aircraft were detected.
- (3) Link 4A one-way range exceeded expectations (Link maintained at 458nm).
- (4) Communications were excellent.
 - (a) WSC-3 satellite links (E-3A/Pt Mugu/Washington, DC) worked well.
 - (b) KY-28 covered UHF comms were adequate.
- (5) Excellent E-3A battle management capabilities were demonstrated.

b. F-14/A-6 operations:

- (1) Mission aircraft reliability was outstanding and all sorties were met. All F-14/A-6E were FMC. All but one sortie flown for scheduled mission duration. One F-14 returned to base after four hours of mission time due to aircraft airframe discrepancy.
- (2) All aggressor aircraft were intercepted and firing positions were achieved. No aggressor aircraft approached E-3A closer than 58nm prior to simulated weapons release by CAP.
- (3) All VF/VA exercise pilots preferred KC-135 to KA-6 for refueling; 260 kts at FL 250-270 considered optimum for refueling operations. KC-135 utilized on second night to refuel CAPs A, B and C on station.
- (4) VF/VA recoveries made one night in 500 foot ceiling and one mile visibility weather. One A-6 pilot reported vertigo on instrument letdown for recovery and considered that fatigue contributed to the problem.
- (5) Pre-mission changes to a high protein diet contributed to VF/VA pilot ability to sustain long duration missions with minimal reduced efficiency.

c. KC-135 operations:

- (1) All KC-135 aircraft were FMC.
- (2) All refueling operations accomplished essentially as planned. All VF/VA pilots were KC-135 qualified.
- (3) All refueling operations need to be fully briefed to ensure Navy/AF participants utilize common procedures.

8. ~~(S)~~^(U) Conclusions and Recommendations:

Conclusions

- a. ~~(S)~~^(U) The E-3A/F-14 weapons system performed better than expected in the fighter suppression role both within and outside the E-3A radar envelope.
- b. ~~(S)~~^(U) E-3A proved very efficient in battle management role. The E-3A secure voice satellite terminals provided interaircraft and long distance (2000 NM) communications of consistently high quality. E-3A is capable of expanded command and control application for Rapid Reaction Contingency Operations.
- c. ~~(S)~~^(U) The KA-6D cannot transfer fuel from fuselage wing tanks to drop tanks. When refueling from KC-135 (even at reduced pumping rates) the KA-6D is required to remain in the area of KC-135 for extended periods to obtain full fuel load or to conduct consolidation operations with another KA-6D.

Recommendations

- a. ~~(S)~~^(U) Continue to exercise the F-14 and E-3A in coordinated operations. Incorporate E-3A/F-14 system into 27 Sep special operations rehearsal. AF intends to designate specific E-3A and KC-135 crews for future SENTINEL SWORD type exercises and any possible contingency operations. SENTINEL SWORD experienced Navy VF/VA pilots should be used to brief Navy pilots prior to any contingency operation.
- b. ~~(S)~~^(U) Exercise E-3A for overall battle management of special contingency operations. Use a secure voice satellite terminal aboard the E-3A when long distance communications is required.
- c. ~~(S)~~^(U) Utilize KC-135 vice KA-6D to refuel CAPS A and B on station. Utilize KA-6D for wet wing tanker role.

SECRET

E-3A/F-14/A-6 COORDINATION EXERCISE

1. Purpose. In conjunction with JCS initiatives to increase the capabilities of Rapid Reaction Forces, a requirement exists to exercise Navy F-14, Air Force E-3A AWACS coordination procedures operating at extended ranges from home bases.

2. Objectives. Exercise objectives include:

- a. Evaluate F-14/E-3 weapons effectiveness inside and outside E-3A radar range. Evaluate E-3A to F-14 one way link 4A procedures and secure comms interface at extended ranges.
- b. Establish/refine airfield neutralization techniques. Use F-14/A-6 under E-3A control to keep fighters on ground, destroy fighters in the air, or interdict runway.
- c. Establish/refine procedures to use IFF to best advantage (assume mission country equipped with Western aircraft).
- d. Conduct safe corridor operation and evaluate other mission rollback procedures.
- e. Evaluate capabilities to conduct mission at extreme range from F-14 aircraft carrier and AF staging base. Verify fuel consumption data. Refuel Navy aircraft from KA-6D (on station) and KC-135 during ingress and egress. Evaluate F-14 crew capability to sustain long duration mission.

3. Concept:

- a. Concept of operations is to simulate the operation of four F-14 fighters (and one or two A-6 attack) on CAP stations at the following ranges from the carrier:
 - Two F-14's (air-to-air configured) 950 NM from carrier (CAP Station A-see map).
 - One F-14 (air-to-air configured) 740 NM from carrier (CAP Station B).
 - One F-14 (air-to-air configured) and two A-6's (air-to-ground configured) 540 NM from carrier (CAP Station C).

~~SECRET~~

~~SECRET~~

- b. Fighters are to maintain combat package as follows:
 - CAP A - two hours
 - CAP B - three hours and thirty minutes
 - CAP C - approximately four hours
 - c. Mission of CAP A and B: Engage simulated enemy fighters as directed by AWACS reacting from southwestern U.S. airfields. Details in Annex A and B.
 - d. Mission of CAP C: Fighter engage simulated enemy fighters as directed by AWACS, protect AWACS and tankers in vicinity of station C and protect final rollback. A-6 interdict airfield as directed. Refuel approximately every hour to maintain combat package. Details in Annex C.
 - e. Mission of E-3A: Refuel en route, arrive on station (Point E) as CAP A and B complete refueling and take final vector for station. Remain on station until fighter rollback and provide command and control for other mission aircraft. Details at Annex D.
 - f. Mission of KC-135: Refuel F-14, A-6, and E-3A as required. See Annex E for approximate requirements.
 - g. Mission of KA-6D: provide one on station refueling to CAPS A and B. See Annex F.
 - h. Mission of opposition fighters: Air Force F-4/F-5 react to mission aircraft. Detail to be worked out later.
4. Planning Conference and Execution.
- a. A planning conference will be held at Tinker AFB, Oklahoma City, Oklahoma on 6 August 1980 to develop a complete exercise plan. This plan is for general guidance only. The coordination exercise is tentatively scheduled for 12 and 13 August.

1 Sufficient fuel to take vectors away from tanker and have 3500 pounds of fuel for engagement.

SECRET

ANNEX A - CAF STATION A

Mission: Maintain two F-14 on RESCAP Station A. Engage fighters reacting from selected Nellis AFB. Remain on station about two hours with a combat package. Carry exercise weapons load.

Flight Profile (approximate):

<u>Location</u>	<u>Event</u>	<u>Distance</u>	<u>Time</u>	<u>Fuel</u> Expend/Remain
NAS to D (Via H)	Launch/climb/transit	410	1:05	6300/12700
D to C	Tank (8K ea)	125	:25	1800/19K
C* to A	Tactical	360	:51	3825/15175
On Station	(Combat Package)	Loiter	:38	2850/12K
On Station	Tank with KA6D (7K)	--	:10	-/19K
	(3 hrs, 1 minute into mission)			
On Station	Tactical	--	1:20	7K/12K
-----	React to fighter **	200	:40	5750/6250
A to C	Tactical	360	:51	3825/2425
C to D	Tank (10K)	125	:25	1800/10625
D to NAS (Via H)	Tactical/Recover	410	1:05	6300/4325

* Assumes 19K on departure from C, then 4500 lbs/hr at 35,000 MSL, 420 TAS.

** Prevent reacting fighter from reaching Fallon.

SECRET

~~SECRET~~

ANNEX B - CAP STATION B

Mission: Maintain one F-14 on RESCAP Station A. Engage fighters reacting from Vandenberg AFB. Remain on station about three and a half hours with a combat package. Carry exercise weapons load.

Flight Profile:

<u>Location</u>	<u>Event</u>	<u>Distance</u>	<u>Time</u>	<u>Fuel</u> Expend/Remain
NAS to C	Same as A			-/19K
C* to B		195	:28	2100/16900
On Station	(Combat Package)	Loiter	1:30	6750/10075
On Station	Tank with KA6D (9K)	--	:10	-/19K
	(3 hrs, 37 minutes into mission)			
On Station	Tactical	--	1:20	9K/10K
-----	React to fighter **	200	:40	5750/4250
B to C	Tactical	195	:28	2100/2150
C to D	Tank (10K)	125	:25	1800/10350
D to NAS (Via H)	Tactical/Recover	410	1:05	6300/4050

* Assumes 19K on departure from C, then 4500 lbs/hr at 35,000 MSL, 420 TAS.

** Prevent reacting fighter from reaching E-3A.

~~SECRET~~

~~SECRET~~

ANNEX C - CAP STATION C

Mission: Maintain one F-14's and two A-6 CAP Station vicinity C. Remain on station (combat package*) to fill vacancies of Stations B or D, protect E-3A and tankers and to interdict airfields as directed. Remain on station to cover final roll-back. Carry exercise weapons load.

Flight Profile (approximate):

<u>Location</u>	<u>Event</u>	<u>Distance</u>	<u>Time</u>	<u>Fuel</u> Expend/Remain
NAS to C (Via H and D)	F-14/2A-6 Launch/climb/tactical	535	1:30	8K/11K
C	F-14/2A-6 Tank (8K each)	---	:10	2250/19K
-----	2A-6 Interdict mission AFB and return to C (Tank if required - 8K)	800	2:00	12K/7K
C	F-14 Tank (4K) (3:30 min into mission)	---	:10	-/19K
C	F-14 Tank (4K) (5 hrs into mission)	---	:10	-/19K
-	F-14 React to fighter	400	1:20	12K/3K
-				
C	F-14 Tank (10K)	---	:10	-/13K
C to NAS	A-6 Tactical/Recover	535	1:30	8K/7K
C to NAS (Via H and D)	F-14 Tactical/Recover	535	1:30	8100/4900

* Combat Package -- with 15K can react 490 NM/70 min/3150 K, have 3500 pounds for combat and return to vicinity of D with 2K pounds fuel reserve.

~~SECRET~~

~~SECRET~~

ANNEX D

E-3A SUPPORT TO FIGHTERS

Mission: Provide radar coverage of airfields, command, control and communications to F-14, and relay for SIGINT warnings.

Flight Profile (approximate):

<u>Location</u>	<u>Event</u>	<u>Distance</u>	<u>Time</u>	<u>Fuel Expend/Remain</u>
Tinker to F	launch/ climb/ transit	600NM	:90	22500/121.5K
F to G	Refuel (25K)	210	:30	7500/139K
G to D	Tactical	250	:36	9000/130K
D to E	Tactical	55	:17	2000/128K
E3 ORBIT(E)	Tactical	-	4:30	67.5K/61.5
E to Tinker (Via F and H)	Tactical	1115	2:39	39750/21750

E-3 Capabilities

- Radar 210NM low alt
250NM above 2000 ft.
- UHF comm range 220-250 NM
- Link4A -One Way
- 440 TAS cruise/350-400 KTS on station
- Maximum fuel capacity - 147K
- 250 lbs/min or 15000 lbs hr

~~SECRET~~

~~SECRET~~

ANNEX E

KC-135 REQUIREMENTS AND TIMING

START/STOP	LOCATION	KC-135	RECEIVER	AMOUNT EACH	AMOUNT TOTAL
2330/2400	F to G	#1	E-3A	25K	25K
2335/2405	D to C	#2	3 F-14 (A,B)	8.5K	25.5K
2400/0020	C	#3	2 KA-6D	7K	14K
0030/0100	C	#3	1 F-14 (C) 2 A-6	8K	24K
0045/0055	C	#4	1 KA-6D	7K	7K
0200/0215	C	#4	1 F-14 (C)	4K	4K
0240/0300	C	#4	2 KA-6D	5K/3K	8K
0330/0340	C	#5	1 F-14 (C)	4K	4K
0420/0440	C	#5	2 F-14 (A)	10K	20K
0440/0450	C to D	#6	1 F-14 (B)	10K	<u>10K</u>
					141.5K

~~SECRET~~

~~SECRET~~

ANNEX F

KA-6D SUPPORT

Mission: Provide one on station refueling for CAP
Stations A and B.

Flight Profile (approximate):

<u>Location</u>	<u>Event</u>	<u>Distance</u>	<u>Time</u>	<u>Fuel</u> Giveaway/Receive
NAS to C (Via H and D)	Launch/climb/transit	535	1:30	
C	Tank			-/7K ea
<u>A SUPPORT</u>				
C to A	Tactical	360	:52	
On Station A	Tank A		:10	7K/-
A to C	Tactical	360	:52	
C	Tank (KC-135)		:10	-/5K
<u>B SUPPORT</u>				
C to B	Tactical	190	:27	
On Station B	Tank B		:10	9K/-
B to C	Tactical	190	:27	
C	Tank (KC-135)		:10	-/3K
<u>RETURN</u>				
C to NAS (Via D and H)	Tactical	535	1:20	

SECRET

~~CONFIDENTIAL~~

6 AUGUST CONFERENCE PARTICIPANTS

<u>OFFICE</u>	<u>G</u> <u>NAME</u>	<u>FUNCTION</u>	<u>AUTOVON</u>
JCS/J-3	RADM W. A. GURECK	NAVY OPS	225-507
JCS/J-3	MAJ [REDACTED]	AIR OPS	225-580
JCS/J-6	LTCOL [REDACTED]	COMM	225-540
TAC/DOA	MAJ [REDACTED]	E3A/OPS	432-574
552 AWACW/DO4	MAJ [REDACTED]	STRAT/TACTICS	735-612
552 AWACW/DOX	LTCOL [REDACTED]	PLANS	735-785
963 AWACS/DOTW	MAJ [REDACTED]	SENSOR DIRECTOR	735-412
474 TFW/430 TFS/DO	MAJ [REDACTED]	NORTH AGGRESSOR	682-290
VA-196	CDR [REDACTED]	A-6E/KA-6D	820-315
VA-196	LCDR [REDACTED]	A-6E/KA-6D	820-333
VF-124	LCDR [REDACTED]	F-14 OPS	959-338
HDQTS USAF/XOOTT	MAJ [REDACTED]	AIR STAFF (TACTICS)	225-039
COM FITAEWWINGPAC	LCDR [REDACTED]	F-14 TACTICS	959-221
HQ SAC/DO8	CAPT [REDACTED]	KC-135 OPS	271-354
964 AWACS/DOT	LTCOL [REDACTED]	SQ SCHED	735-619
552 AWACW DO8 (NLO)	CDR [REDACTED]	WING NAVAL LIAISON	735-739
963 AWACS DOOM	LTCOL [REDACTED]	ASST OPS OFF	735-607
963 AWACS/CC	COL [REDACTED]	MISSION COMMANDER	735-615
FAA	[REDACTED]	FAA	735-254

~~CONFIDENTIAL~~

DEPARTMENT OF DEFENSE

JOINT CHIEFS OF STAFF

MESSAGE CENTER

PAGE 2

~~SECRET~~

2534

A. EVALUATE F-14/E-3A MISSION EFFECTIVENESS INSIDE AND OUTSIDE E-3A RADAR RANGE. EVALUATE E-3A TO F-14 ONE WAY LINK 4A PROCEDURES AND SECURE COMM INTERFACE AT EXTENDED RANGES.

B. ESTABLISH/REFINE AIRFIELD NEUTRALIZATION TECHNIQUES. USE F-14/A-6 UNDER E-3A CONTROL TO KEEP FIGHTERS ON GROUND, DESTROY FIGHTERS IN THE AIR, OR INTERDICT RUNWAYS.

C. ESTABLISH/REFINE PROCEDURES TO USE IFF TO BEST ADVANTAGE (ASSUME MISSION COUNTRY EQUIPPED WITH WESTERN AIRCRAFT).

D. EVALUATE MISSION ROLLBACK PROCEDURES. EVALUATE CAPABILITIES TO CONDUCT MISSION AT EXTREME RANGE FROM F-14 AIRCRAFT CARRIER AND AF STAGING BASE. VERIFY FUEL CONSUMPTION DATA. REFUEL NAVY AIRCRAFT, FROM KA-6D (ON STATION) AND KC-135 DURING INGRESS AND EGRESS. EVALUATE F-14 CREW CAPABILITY TO SUSTAIN LONG DURATION MISSION.

2. (U) PARTICIPANTS: 552 AWACW, 474 TFW, COMFITAEWINGPAC, COMMATVAQWINGPAC, 228MW, 307 AFG.E. (S) SUPPORT TASKINGS:

A. 552 AWACW REQUESTED TO PROVIDE ONE PRIMARY AND ONE BACKUP E-3A (AIRBORNE) TO BE ON STATION FOR FOUR AND ONE HALF HOURS TO PROVIDE SURVEILLANCE AND CONTROL IAW MISSION PROCEDURES. MISSION COMMANDER COL B. J. HOWARD AV 735-6151 PLANNING LT COL TOM HOWELL 735-7851.

B. 474 TFW REQUESTED TO PROVIDE 4 F-4D SORTIES (2-4) AIRCRAFT TO FLY AGGRESSOR TRACKS IAW PART II B.5. POC MAJOR JERRY NARANCICH, 682-2900/2901.

C. COMFITAEWINGPAC REQUESTED TO PROVIDE F-14 AIRCRAFT FOR CAP OPERATIONS AND F-4 AIRCRAFT FOR AGGRESSOR OPERATIONS, IAW PART II B.2 AND 5. POC LCDR C.A. CLABAUGH 959-2211.

D. COMMATVAQWINGPAC REQUESTED TO PROVIDE A6E AND KA6D AIRCRAFT TO PROVIDE STRIKE AND TANKER OPERATIONS IAW PART TWO B.3. POC - CDR DAVID RUSSELL 820-3155.

E. HQ SAC (DOR) REQUESTED TO PROVIDE KC-135 AIRCRAFT FOR REFUELING/OPERATIONS IAW PART II B.4.

F. POINT MUGU NAS, PLEAD CONTROL REQUESTED TO PROVIDE THE NECESSARY SUPPORT TO THE EXERCISE DIRECTOR AS REQUESTED AND COORDINATED BY JCS/J3.

G. JCS/J3 WILL COORDINATE.

(1) SAR SUPPORT BETWEEN 0300Z AND 0930Z 13 AUG AND 0500Z TO 1130Z ON 14 AUG.

(2) USE OF W-289/290 AND CAE 1177 IN ALL ALTITUDES 0300Z-0930Z 13 AUG AND 0500Z TO 1130Z 14 AUG.

(3) A BLOCKED AIRSPACE 10 NM EITHER SIDE OF CENTER LINE FROM 3400N/12019W TO 3714N/11653W FOR TANKER/F-14 TRANSIT AT FL 240-260 AND 350-370 FROM 0300Z TO 0600Z 13 AUG AND 0500Z-0800Z 14 AUG.

PAGE 2

~~SECRET~~

00001001

DEPARTMENT OF DEFENSE

JOINT CHIEFS OF STAFF

MESSAGE CENTER

PAGE 3

2534

(4) BLOCK NELLIS RANGES R-4207/5/9 FROM FL 180-400 FROM 0330Z-0630Z 13 AUG AND 0530-0830 14 AUG.

H. 57TFW WILL HAVE BARON CONTROL MANNED TO PROVIDE AIRSPACE INTEGRITY CALLS TO F-14 CAP AIRCRAFT WORKING CAP ALFA. ONLY FLIGHT SAFETY CALLS OR AIRSPACE SPILLOUTS CALLS ARE REQUIRED ON 390.2 OR 243.07 MONITOR TIMES ARE 0330Z TO 0600Z 13 AUG AND 0530 TO 0800Z 14 AUG.

I. JCS TO PROVIDE TWO WSC 3'S TO 552 AWACH.

PART II OPERATIONS

A. (U) (S) GENERAL:

(1) CONCEPT OF OPERATIONS: FOUR F-14 FIGHTERS (AND ONE OR TWO A-6 ATTACK) ON CAP STATION AT THE FOLLOWING POSITIONS:

(A). TWO F-14'S (AIR-TO-AIR CONFIGURED) 3727N 11650W CAP STATION ALFA.

(B) ONE F-14 (AIR-TO-AIR CONFIGURED) 3315N 11900W CAP STATION BRAVO.

(C) ONE F-14 (AIR-TO-AIR CONFIGURED) AND TWO A-6'S (AIR-TO-GROUND CONFIGURED) 3248N 12135W CAP STATION CHARLIE.

(D) E-3A WILL ORBIT IN W289.

B. FIGHTERS ARE TO MAINTAIN COMBAT PACKAGE AS FOLLOWS:

(1) CAP ALFA - TWO HOURS

(2) CAP BRAVO - THREE HOURS AND THIRTY MINUTES

(3) CAP CHARLIE - APPROXIMATELY FOUR HOURS

C. MISSION OF CAP ALFA IS CONDUCT AUTONOMOUS SEARCH AND ENGAGEMENT OPERATIONS OF SIMULATED ENEMY FIGHTERS ENTERING DEFENDER AREA.

D. MISSION CAP BRAVO: ENGAGE SIMULATED ENEMY FIGHTERS AS DIRECTED BY AWACS REACTING FROM SOUTHWESTERN AGGRESSOR AIRFIELDS.

E. MISSION OF CAP CHARLIE: ENGAGE SIMULATED ENEMY FIGHTERS AS DIRECTED BY AWACS, PROTECT AWACS AND TANKERS IN VICINITY OF CAP CHARLIE AND PROTECT FINAL ROLLBACK. A-6 INTERDICT AIRFIELD AS DIRECTED. REFUEL APPROXIMATELY EVERY HOUR TO MAINTAIN COMBAT PACKAGE.

F. MISSION OF E-3A: REFUEL ENROUTE, ARRIVE ON STATION AS CAP ALFA AND BRAVO COMPLETE REFUELING AND ASSUME STATION. REMAIN ON STATION UNTIL FIGHTER ROLLBACK AND PROVIDE COMMAND AND CONTROL FOR OTHER MISSION AIRCRAFT.

G. MISSION OF KC-135: REFUEL F-14, A-6, AND E-3A AS REQUIRED.

H. MISSION OF KA-6D: PROVIDE ONE ON STATION REFUELING TO CAPS ALFA AND BRAVO.

I. MISSION OF OPPOSITION FIGHTERS: AIR FORCE F-4'S AND NAVY F-4'S REACT TO MISSION AIRCRAFT.

J. E-3A WILL BATTLEMANAGE ALL SENTINEL SWORD AIRCRAFT EXCEPT F-14 AIRCRAFT ON CAP "ALFA" AND AGGRESSOR FORCES.

PAGE 3

~~SECRET~~

00001001

DEPARTMENT OF DEFENSE

JOINT CHIEFS OF STAFF

MESSAGE CENTER

PAGE 4

~~SECRET~~

2534

K. AGGRESSOR GENERAL SCENARIO - AGGRESSOR FORCES WILL ADHERE
TO THE GUIDANCE PROVIDED IN THIS FRAG ORDER AND NOT

BT

#4119

ANNOTES

CLH

PAGE 4

~~SECRET~~

00001001

NNNN

091710Z

DEPARTMENT OF DEFENSE

JOINT CHIEFS OF STAFF

MESSAGE CENTER

VZCZCHLT940
MULT

~~SECRET~~

ZYUW

2534
SECT 02 OF 02534

ACTION...

J3(05)

DISTR

OPR CJCS:(02) CJCS DJS(01) SJCS(01) FILE

(009)

TRANSIT/091705Z/091715Z/000110GRP1009

DE RUEKJCS #4120 2221715

ZNY SSSSS

~~0~~ 091705Z AUG 80

FM JCS WASHINGTON DC//J3-S00//

TO RUCIPBA/TAC LANGLEY AFB VA//DOA/DODW//

RUCJAAA/USCINCRD MACDILL AFB FL

RUVQABA/552AWCW TINKER AFB OK//DO/CC/963/964//

RUWTEKA/HQ SAC OFFUTT AFB NE//DO/LG//

RHFIAAAA/228MW MARCH AFB CA//DO/MA//

RUCVAAA/8AF BARKSDALE AFB LA//DO/LG//

RUWMEFA/307AREFG TRAVIS AFB CA//DO/MA//

RHFIAAAA/15AF MARCH AFB CA//DO/LG//

RUWTPGA/12AF BERGSTROM AFB TX//DO//

RUWJBMA/474TFW NELLIS AFB NV//DO//

RUWDVAA/COMFITAEWINGPAC SAN DIEGO CA

RUWJCHA/COMATVAQWINGPAC NAS WHIDBEY WA

RUWDPA/COMPACMISTESTCEN PT MUGU CA

RUWJBMA/57TTW NELLIS AFB NV/DA

BT

~~SECRET~~ 2534

SECTION 2 OF 5

INNOVATE OR MODIFY BRIEFED PROCEDURES. AGGRESSORS WILL FILE INDIVIDUAL FLIGHT PLANS WITH A MINIMUM TEN MINUTE SEPARATION BETWEEN SINGLE SHIP LAUNCHES.

(1) TAKEOFF TIMES FOR NELLIS AGGRESSORS MAY BE AT ANY TIME BETWEEN 0415Z AND 0545Z, NIGHT ONE AND 0615Z TO 0745Z NIGHT TWO. ROUTE OF FLIGHT WILL BE NELLIS TO FALLON NAS SQUAWKING MODE 1 CODE 51 MODE 2 CODE 6100, MODE 3 CODE 61XX (LAST TWO DIGITS AS ASSIGNED BY FAA).

(2) TAKEOFF TIMES FOR MIRAMAR AGGRESSORS MAY BE AT ANYTIME BETWEEN 0415Z AND 0830Z FIRST NIGHT AND 0615Z TO 1000Z SECOND NIGHT. ROUTE OF FLIGHT WILL BE MIRAMAR TO EITHER AWACS ORBIT AREA OR CAP BRAVO ORBIT. SQUAWKING MODE 1 CODE 61, MODE II CODE 6100 MODE 3 CODE 61XX (LAST TWO DIGITS AS ASSIGNED BY FAA).

PAGE 1

~~SECRET~~

00001001

DEPARTMENT OF DEFENSE

JOINT CHIEFS OF STAFF

MESSAGE CENTER

PAGE 2

S E C R E T

2534

(3) AN AGGRESSOR ATTACK WILL ONLY ENTAIL MOVEMENT TOWARD THE TARGET AND INTERCEPT FROM TARGET WILL TERMINATE NO CLOSER THAN 5NM. TARGETS FOR MIRAMAR F4S ARE E3A, CAPS CHARLIE AND BRAVO. FOR NELLIS F4S, CAP ALFA.

L. ALL AGGRESSOR AND F-14 AIRCRAFT MUST HAVE A FULLY OPERATIONAL IFF AND OPERATIONAL ON ASSIGNED MODES AND CODES.

M. SECURE VOICE (KY-28) WILL BE USED 0400Z-0830Z FIRST NIGHT AND 0600-1030Z SECOND NIGHT. INITIAL CONTACT CAN BE MADE IN CLEAR.

N. REFERENCE POINTS:

A. 3727N 11050W.
 B. 3315N 11900W.
 C. 3248N 12135W.
 D. 3256N 11915W.
 E. 3325N 12015W.
 F. 3425N 10920W.
 G. 3352N 11325W.
 H. 3340N 11430W.

I. 35-10N 118-20W EA6B JAMMER IF USED.

O. F-14 MODE II CODE 3001-3002-3003-3004

A6E MODE II CODED 4001, 4002

KA6D MODE II CODE 4021, 4022, 4023

MODE 3 ATC ASSIGNED

B (U) (S) MISSION PROCEDURES

1. AWACS OPS.

552 AWACW WILL PROVIDE E3A BATTLE MANAGEMENT AIRCRAFT TO EXERCISE NAVY F-14/AIR FORCE E3A COORDINATION PROCEDURES IN CONJUNCTION WITH JCS RAPID REACTION FORCE DIRECTION. SPECIFICALLY TO BE EVALUATED ARE:

A. F-14/E3A MISSION EFFECTIVENESS INSIDE AND OUTSIDE E3A RADAR RANGE AND E3A TO F-14 ONE WAY LINK 4A PROCEDURES AND SECURE COMM INTERFACE AT EXTENDED RANGES.

B. ESTABLISH/REFINE AIRFIELD NEUTRALIZATION TECHNIQUES.

C. ESTABLISH/REFINE PROCEDURES TO USE IFF TO BEST ADVANTAGE.

D. EVALUATE CAPABILITIES TO CONDUCT MISSION AT EXTREME RANGE FROM F-14 AIRCRAFT (SIMULATED) CARRIER AND AF STAGING BASE. TO ACCOMPLISH THESE OBJECTIVES, THE E3A WILL PROVIDE RADAR COVERAGE OF AIRFIELDS, COMMAND, CONTRCL, AND COMMUNICATIONS TO F-14 AND RELAY FOR SIGINT WARNINGS. SAR ASSISTANCE AND AERIAL REFUELING SUPPORT.

2. F-14 OPERATIONS.

A. ASSETS REQUIRED.

(1) FIGHTER 4 F-14A PRIMARY/2 F-14A SPARE.

B. F-14 CONFIGURATION:

(1) 2PH 2SP, 2SW, PLUS ANCILLARY EQUIPMENT. IF NO PH AVAIL

PAGE 2

~~SECRET~~

00001001

DEPARTMENT OF DEFENSE

JOINT CHIEFS OF STAFF

MESSAGE CENTER

PAGE 3

~~SECRET~~

2534

LOAD 2PH RAILS.

(2) APX-76, OPERATE UNK 4A AND MARK VII (MODE IV CAPABLE)

IFF.

(3) EXERCISE FUEL TANKS AND ANCILLARY EQUIPMENT.

(4) FUNCTIONAL AFCS.

(5) KY-20.

(6) UHF/ICS RECORD CAPABILITY.

(C) REQUIREMENTS.

(1) WAIVER OF EXT FUEL TANK RESTRICTION.

(2) AIRCREWS REQUIRE NIGHT KA-60 AND KC-135 QUALIFICATION PRIOR TO START OF MISSION.

(D) F-14 MISSION NARRATIVE.

(1) 2 F-14S CALL SIGN HOPPY 1 AND 2 LAUNCH FROM NAS MIRAMAR AT 0139Z AND PROCEED TO POINT DELTA VIA POINT HOTEL. AT POINT DELTA, 0244Z RENZ WITH KC-135 AT 25,000 AND TANK TO 20,000 LB WHILE PROCEEDING TO POINT CHARLIE (0309Z). DEPART POINT CHARLIE CLIMBING TO 36,000 AND PROCEED TO POINT ALFA (0400Z). UPON ARRIVAL AT POINT ALFA RENZ WITH MILESTONE 521/522 (KA6D) TANK TO 19,000 LB. REMAIN ON CAP ALFA FOR APPROX 2 HOURS. RADAR THREAT SECTOR TOWARD NELLIS AFB, MAX ENDURANCE PROFILE. UPON REACHING A FUEL STATE OF 6500 LB. DEPART POINT ALFA FOR POINT CHARLIE. RENZ WITH KC-135 AT POINT CHARLIE AND TANK ENROUTE TO POINT DELTA (25,000 FEET). RECEIVE 10,000 LBS. FROM KC-135 PROCEEDING FROM POINT CHARLIE TO DELTA, DEPART POINT DELTA AND PROCEED TO POINT HOTEL. FROM HOTEL PROCEED DIRECTLY TO NAS MIRAMAR TO LAND WITH 4000 LBS. FLIGHT TIME OF MISSION IS ESTIMATED TO BE 7 HOURS 30 MINUTES. FIGHTERS WILL NOT ENTER BLOCK FROM 18-23K WHILE ON CAP UNLESS RADAR CONTACT HELD WITH AGGRESSOR AIRCRAFT. MISSION ASSUMES 19,000 FUEL DEPARTING FROM CHARLIE, THENCE 4500 PPH AT 35,000 MSL, 420 TAS.

(2) F-14, CALL SIGN HOPPY 3 LAUNCH FROM NAS MIRAMAR AT 130230Z/140430Z, PROCEED TO ~~POINT~~ CHARLIE USING SAME PROFILE AS CAP ALFA. PROCEED TO CAP BRAVO. CHECK IN ON 390.2 WITH E3A. MAINTAIN MAXIMUM ENDURANCE PROFILE, RADAR SURVEILLANCE OF THREAT SECTOR DIRECTED TOWARD NAS MIRAMAR. TANK ON STATION WITH KA-60 (MILESTONE 523) AT 130630Z/140830Z TAKING ON 9000 LBS FUEL. VECTOR AGAINST AGGRESSORS AS DIRECTED BY E3A. NLT 130940Z/141140Z OR WHEN FUEL REQUIRES PROCEED TO CAP CHARLIE. AT CAP CHARLIE, PROCEED TO POINT DELTA. TANK ENROUTE WITH KC-135 CALLSIGNS GRIM 11-15 TAKING ON 10,000 LBS FUEL. MISSION ASSUMES 19,000 LBS FUEL AT COMPLETION OF TANKING ON STATION WITH KA-60, THENCE 4500 PPH AT 35,000 FT, 420 TAS. F-14 MISSION IS TO PREVENT AGGRESSOR FIGHTERS FROM REACHING E3A.

(3) 1/F-14 CALL SIGN HOPPY 4 LAUNCH FROM NAS MIRAMAR AT 130230Z/140430 AND PROCEED TO POINT CHARLIE VIA HOTEL, DELTA

PAGE 3

~~SECRET~~

00001001

DEPARTMENT OF DEFENSE

JOINT CHIEFS OF STAFF

MESSAGE CENTER

PAGE 4

~~SECRET~~

2534

AT 35,000; ARRIVE CAP CHARLIE AT 130400Z/140600Z, UPON
ARRIVAL AT CAP CHARLIE, DESCEND TO 25,000 FEET, RENZ WITH KC-135,
TANK TO 19,000 LB. REMAIN ON STATION FOR APPROX FOUR HOURS AT
TIME 130600Z/140600Z RECEIVE 4,000 LB. AT TIME 130730Z/140930Z

BT

44120

ANNOTES

CLM

PAGE 4

~~SECRET~~

00001071

VNNN

091715Z

DEPARTMENT OF DEFENSE

JOINT CHIEFS OF STAFF

MESSAGE CENTER

VZCZCMLT941ILN738
MULT~~SECRET~~

ZYUW

2534

SECT 03 OF 02534

ACTION..

J3(25)

DISTR

(009) OPR CJCS:(02) CJCS OJS(01) SJCS(01) FILE

TRANSIT/091705Z/091719Z/000114GRP1005

DE RUEKJCS #4121 2221719

ZNY SSSSS

O 091705Z AUG 80

FM JCS WASHINGTON DC//J3-SOD//

TO RUCIPBA/TAC LANGLEY AFB VA//DOA/DOOW//

RUCJAAA/USCINCRD MACDILL AFB FL

RUVQABA/552AWCW TINKER AFB OK//DO/CC/963/964//

RUWTEKA/HQ SAC OFFUTT AFB NE//DO/LG//

RHFIAAA/228MW MARCH AFB CA//DO/MA//

RUCVAAA/8AF BARKSDALE AFB LA//DO/LG//

RUWMEFA/307AREFG TRAVIS AFB CA//DO/MA//

RHFIAAA/15AF MARCH AFB CA//DO/LG//

RUWTPGA/12AF BERGSTROM AFB TX//DO//

RUWJBMA/474TFW NELLIS AFB NV//DO//

RUWDVAA/COMFITAEWINGPAC SAN DIEGO CA

RUWJDHA/COMATVAQWINGPAC NAS WHIDBEY WA

RUWDPAA/COMPACMISTESTCEN PT MUGU CA

RUWJBMA/57TTW NELLIS AFB NV/DA

BT

SECRET 2534

SECTION 3 OF 5

RECEIVE ANOTHER 4,000 LB. FROM KC-135. REMAIN ON CAP CHARLIE WITH COMBAT PACKAGE TO FILL VACANCIES OF STATIONS ALPHA AND BRAVO. PROTECT E3A AND TANKERS OR TO INTERDISCT AIRFIELDS AS DIRECTED. REMAIN ON STATION TO COVER WITHDRAWAL. DEPART CAP CHARLIE 130800Z/141000Z AND PROCEED TO NAS MIRAMAR VIA HOTEL AND DELTA. MISSION TIME IS ESTIMATED TO BE APPROX 7 HOURS.

(4) EXERCISE ROE:

(A) CAP ALPHA AUTONOMOUS OPERATIONS. UTILIZING IFF MODE 1/2 TO VERIFY CONTACTS. ENGAGE AS REQUIRED WITH FORWARD QUARTER WEAPONS WHICH ARE ATTACKABLE WILL BE ENGAGED.

(B) E-3A/F-14 LINK 4A UTILIZATION CODE.

(1) ABORT/RECALL: COMMAND ALTITUDE 70,000 FT FOR 20 SECONDS.

(2) TANKER ASSETS NOT AVAILABLE: COMMAND ALTITUDE 90,000 FT FOR

PAGE 1

~~SECRET~~

00001001

CONTACTS SATISFYING IFF/IFF/IFF REQUIREMENTS

DEPARTMENT OF DEFENSE

JOINT CHIEFS OF STAFF

MESSAGE CENTER

PAGE 2
20 SECONDS.

~~SECRET~~

2534

(5) OVERALL ROE: JM 55-200
 (6) GENERAL GUIDANCE: FILE CO-175 TO DELAY ON STATION AS REQUIRED. INCLUDE TANKING FUEL TRACKS ALTITUDE AS REQUIRED. ALL INTERCEPTS WILL BE CONSUMMATED WITHIN WARNING AREAS, TANKING WILL BE WITHIN BLOCK 24,000-28,000 FT ENDURANCE/INTERCEPT PROFILES AT BLOCK 31,000-35,000 FT. COMBAT PACKAGES WILL BE SUFFICIENT FUEL TO ACCEPT VECTOR AWAY FROM TANKER WITH 3500 LBS FUEL FOR ENGAGEMENT: CAP ALPHA 2 HRS, CAP BRAVO 3 HRS 40 MIN, CAP CHARLIE FOUR HOURS.
 (7) SAFETY. SAFETY WILL NOT BE COMPROMISED DURING ANY PORTION OF MISSION. IT IS RECOGNIZED THAT EXTENDED NIGHT IFR MISSIONS ARE VERY DEMANDING ON AIRCREWS. KNOW YOUR LIMITATIONS AND DO NOT EXCEED THEM.

3. A6-E/KA6D SUPPORT.

A. LAUNCH 2 A6-E ON STRIKE/INTERDICTION MISSION TO ARRIVE POSITION POINT CHARLIE AT 130330Z/140530Z AT FL 240. CONTACT E3A ON ASSIGNED FREQ FOR INSTRUCTIONS. ANTICIPATE MISSION RELEASE TIME OF 130030Z/140830Z AT SAME POSITION. RECOMMEND THREE DROP TANK CONFIGURATION.

B. LAUNCH 3 KA6D'S TO ARRIVE POINT CHARLIE 130300Z/140500Z, FL 240. ANTICIPATE MISSION RELEASE TIME OF 130600Z/140800Z AT SAME POINT.

C. ALL AIRCREW TO BE NIGHT KC-135 CURRENT.

D. AIRCREW SHOULD BE PREPARED FOR MINIMUM FLIGHT TIME OF 6 PLUS 30, MAXIMUM FLIGHT TIME OF 7 PLUS 45.

E. CALL SIGNS FOR EXERCISE ONLY.

A6E'S MILESTONE 501,502

KA6D - MILESTONE 521, 522, AT POINT ALPHA

MILESTONE 523 AT POINT BRAVO

POC CDR DAVID RUSSELL, AV 820-3155

4. TANKER SUPPORT: REQUEST SAC PROVIDE KC-135 AIR REFUELING SUPPORT FOR E-3A AND NAVY KA6/A-6/F-14 CAP SUPPORT. NAVY REFUELING TRAINING WILL BE CONDUCTED PRIOR TO MISSION IAW INTERSERVICE SUPPORT AGREEMENT.

(A) E3A SUPPORT: CONCEPT OF OPERATIONS IS TO REFUEL E3A ENROUTE, USING POINT PARALLEL RENDEZVOUS, IN A/R 3HW.

ARCT	AREA	ALT	RCVRS	OFFLOAD
130215Z	AR3HW	285	2/E3A	30M EA/60M TOTAL
140415Z	ARHW	285	2/E3A	30M EA/60M TOTAL

CR PLAN: AS PUBLISHED IN FLIP IB

TANKER/RECEIVER CALL SIGNS: UNIT VOICE CALL SIGN LIST

(B) CAP SUPPORT. CONCEPT OF OPERATIONS IS FOR DROGUE - EQUIPPED KC-135 AIRCRAFT TO PROVIDE A/R SUPPORT FOR F-14/KA-6/A-6 AIRCRAFT IN A DESIGNATED REFUELING AREA, PURPLE ANCHOR, IN W-289. KC-135S WILL ENTER AND EXIT AT DESIGNATED POINTS IN THE ANCHOR: RECEIVERS

PAGE 2.

~~SECRET~~

00001001

(3) THREAT, NOT IN YOUR AREA, COMMAND ALTITUDE 10000 FEET FOR 20 SECONDS

(4) THREAT, YOUR AREA, COMMAND ALTITUDE 15000 FEET FOR 20 SECONDS.

DEPARTMENT OF DEFENSE

JOINT CHIEFS OF STAFF

MESSAGE CENTER

2534

PAGE 3

~~SECRET~~

WILL BE VECTORED FOR JOIN-UP BY PURPLE ANCHOR CONTROL, (E3A)

(1) PURPLE ANCHOR IS DEFINED AS FOLLOWS:

ENTRY PTS:

PURPLE NORTH: 3330N 12130W

PURPLE SOUTH: 3217N 121302

ARIP: 3248N 121352 (POINT CHARLIE)

ARCP: 3252N 12030W

EXIT POINT: 3256N 11915W (POINT DELTA)

CONTROLLING AGENCY: PURPLE ANCHOR CONTROL

FREQUENCIES: CONTROL - P. 283.6/B.U. 235.2

REFUELING - 398.5/B.U. 368.6

ALTITUDE: FL 240-280

(2) AFTER 130400Z (NIGHT ONE) AND 140600Z (NIGHT TWO) KC-135 WILL ENTER PURPLE ANCHOR AT EITHER THE NORTH OR SOUTH ENTRY POINT AT FL 270. CONTACT PURPLE ANCHOR ON STATION REPLACEMENT. BASIC REFUELING CONCEPT IS TO HOLD AT FL 250 EASTBOUND BETWEEN THE ARIP AND ARCP, LEFT HAND ORBIT, WHEN REPLACED, EXIT THROUGH POINT DELTA AT FL 250. PRIOR TO 130400Z/140600Z, PROCEDURES IN NOTE 1, BELOW APPLY.

(3) NIGHT ONE:

TIME	TANKER(KC-135)	RECEIVERS	OFFLOAD	NOTES
130245-0310	GRIM 11/12	3/F14	26M	1
130300-0320	GRIM 11/12	3/KA6	39M	1
130330-0400	GRIM 11/12	1/F14,2/A6	34M	1
130500-0515	GRIM 13	1/F-14	4M	
130540-0600	GRIM 13	3KA6	45M	
130600-0630	GRIM 13	2/A6	30M	
130630-0640	GRIM 14	1/F14	4M	
130720-0740	GRIM 14	2/F14	20M	
130740-0750	GRIM 14	1/F14	10M	2

NIGHT TWO:

140445-0510	TWIN 11/12	3/F14	26M	1
140500-0520	TWIN 11/12	3/KA6	39M	1
140530-0620	TWIN 11/12	1/F14,2A6	34M	1
140700-0715	TWIN 13	1/F14	4M	
140740-0800	TWIN 13	3/KA6	45M	
140800-0830	TWIN 13	2/A-6	30M	
140830-0840	TWIN 14	1/F14	4M	

TIME	TANKER(KC-135)	RECEIVERS	OFFLOAD	NOTES
140920-0940	TWIN 14	2/F14	20M	
130940-0950	TWIN 14	1/F14	20M	2

NOTE 1: PURPLE CONTROL WILL NOT ARRIVE ON STATION UNTIL 130400Z ON NIGHT ONE/ 140600Z ON NIGHT TWO. RENDEZVOUS PRIOR TO THOSE

PAGE 3

~~SECRET~~

00001001

DEPARTMENT OF DEFENSE

JOINT CHIEFS OF STAFF

MESSAGE CENTER

PAGE 4

~~SECRET~~

2534

TIMES WILL BE EFFECTED VISUALLY AND ELECTRONICALLY BY THE
RECEIVERS. TANKER 11/12 WILL ENTER PURPLE ANCHOR AT POINT DELTA
BT

#4121

ANNOTES

CLH

PAGE 4

~~SECRET~~

00001001

NNNN

091720Z

DEPARTMENT OF DEFENSE

JOINT CHIEFS OF STAFF
MESSAGE CENTER

VZCZCHLT942
MULT

~~SECRET~~

ZYUW

2534

SECT 04 OF 02534

Sect 4-5 of 5

ACTION--

J3(05)

DISTR

OPR CJCS:(02) CJCS OJS(01) SJCS(01) FILE
(009)

TRANSIT/091705Z/091722Z/000:17GRP0973
DE RUEKJCS #4122 2221722
ZNY SSSSS
O 091705Z AUG 80
FM JCS WASHINGTON DC//J3-S00//
TO RUCIPBA/TAC LANGLEY AFB VA//DOA/DOOW//
RUCJAAA/USCINCRD MACDILL AFB FL
RUV0ABA/552AWCW TINKER AFB OK//DO/CC/963/964//
RUWTEKA/HQ SAC OFFUTT AFB NE//DO/LG//
RHFIAAAA/22BMW MARCH AFB CA//DO/MA//
RUCVAAA/8AF BARKSDALE AFB LA//DO/LG//
RUHMEFA/307AREFG TRAVIS AFB CA//DO/MA//
RHFIAAAA/15AF MARCH AFB CA//DO/LG//
RUWTPGA/12AF BERGSTROM AFB TX//DO//
RUWJBMA/474TFW NELLIS AFB NV//DO//
RUWDVAA/COMFITAEHWINGPAC SAN DIEGO CA
RUWJDHA/COMATVAQWINGPAC NAS WHIDBEY WA
RUWDPAA/COMPACMISTESTCEN PT MUGU CA
RUWJBMA/57TTW NELLIS AFB NV/DA

BT

~~SECRET~~ 2534

SECTION 4 OF 5

(EXIT POINT) AT FL 250, PROCEED TO 3255N 11935W, AND HOLD, 20NH
LEGS, RIGHT HAND ORBIT, ALONG THE LINE FROM 3255N 11935 TO 3254N
12000W. PLAN TO ARRIVE IN ORBIT AT 130230Z (NIGHT ONE AND
140430Z (NIGHT TWO) ADJUST ORBIT TIMING TO ARRIVE OVER 3255N
11935" AT 130246Z/140446Z. THE F-14 RECEIVERS WILL JOIN-UP ON
THE TANKER IN ORBIT. AFTER F-14 JOIN-UP, TANKERS WILL PROCEED
DOWN TRACK TO POINT CHARLIE, AND ENTER HOLDING, BETWEEN THE ARIP
AND ARCP TO ESTABLISH ANCHOR PATTERN DESCRIBED IN PARA B-4(B)(2).
SUGGEST TANKERS 11, 12 ARRIVE IN CELL. NOTE 2: AFTER JOIN-UP WITH
LAST F-14, TANKER 14 WILL DEPART FOR EXIT POINT DELTA WITH RECEIVER
IN TOW.

(4) SUGGESTED TANKER ON-STATION TIMES:

TANKER NIGHT ONE NIGHT TWO

PAGE 1

~~SECRET~~

00001001

DEPARTMENT OF DEFENSE

JOINT CHIEFS OF STAFF

MESSAGE CENTER

PAGE 2

~~SECRET~~

2534

11/12	130230-0430	140430-0630
13	130430-0630	140630-0830
14	130600-0800	140800-1000

(C) COMMUNICATIONS: SEE PART FOUR. THE FOLLOWING SPECIFIC INSTRUCTIONS APPLY FOR CAP REFUELING SUPPORT.

- (1) KC-135'S SHOULD BE KY-28 EQUIPPED.
 - (2) PRIOR TO ARRIVAL OF PURPLE ANCHOR CONTROL (130400Z/140600Z) RENDEZVOUS AND REFUELING WILL BE CONDUCTED IN THE CLEAR ON P.283.6/B.U 235.2.
 - (3) AFTER PURPLE CONTROL ARRIVES ON STATION, RENDEZVOUS WILL BE ON 283.6 SECURE/ REFUELING ON 398.5 CLEAR VOICE.
 - (4) A/A TACAN: 33/96 (RECEIVER/TANKER) YANKEE BAND
APN 69: 1-1-3
APX 78: 5/1
- (D) POC CAPT RAY HICKS AV 271-3541.

5. AF AGGRESSORS OPS.

(A) TASKING

- (1) 474TFW F-4D'S. 474TFW WILL PROVIDE SUFFICIENT AIRCRAFT TO FLY 4 "AGGRESSOR". TRACKS THROUGH THE DESIGNATED EXERCISE RESTRICTED AREAS (R-4808/R-4807/R-4809) ON THE NIGHTS OF 12 AND 13 AUGUST.
- (2) F-4 AIRCRAFT WILL LAUNCH SINGLY FROM AND RETURN TO NELLIS AFB NV ON 12 AND 13 AUGUST TO PROVIDE AGGRESSOR TRACKS THROUGH THE NELLIS RANGE COMPLEX DURING THE FOLLOWING TIME WINDOWS:
FIRST DAY - 13 0400-0600Z
SECOND DAY - 14 0600-0800Z
ONLY 4 TRACKS WILL BE FLOWN EACH TIME BLOCK WITH IFR FLIGHT PLANS FILED AT NELLIS AND BASED UPON SHORTEST ROUTING FROM NELLIS TO "STRIKE" NOTIONAL TARGETS IN THE AREA OF NAS FALLON. ROUTING WILL BE ESSENTIALLY NORTH THROUGH THE WESTERN PORTION OF THE NELLIS RANGE COMPLEX WITH RECOVERIES THROUGH THE DESERT MOA'S.
- (3) WHILE IN THE RESTRICTED AREAS, F-4S WILL BE WITHIN AN ALTITUDE BLOCK F200-230. CAP AIRCRAFT WILL AVOID THIS BLOCK PLUS OR MINUS 2000' UNLESS POSITIVE VISUAL CONTACT IS ACQUIRED.
- (4) TAKEOFF TIMES WILL BE DETERMINED BY THE 474 TFW AND WILL BE STAGGERED TO PUT AGGRESSORS IN THE RESTRICTED AREAS WITHIN THE PRESCRIBED BLOCK TIMES.
- (5) F-4 AGGRESSOR AIRCRAFT WILL MONITOR GUARD (243.0), AUX 13 (277.2), AND 390.2 ONLY IN THE INTEREST OF SAFETY WILL F-4S TRANSMIT ON THOSE FREQUENCIES. MODE I-61 AND MODE II 6100 MODE III CODE 61XX MUST BE SQUAWKED.
- (8) SUPPORT: REQUIRED SQUAWKS MUST BE INCLUDED IN REMARKS SECTION OF DD 175'S.
- (1) AUTONOMOUS SUPPORT TO BE PROVIDED BY 474 TFW.

PAGE 2

~~SECRET~~

00001001

DEPARTMENT OF DEFENSE

JOINT CHIEFS OF STAFF

MESSAGE CENTER

2534

PAGE 3

~~SECRET~~

(2) NO AIR REFUELING REQUIRED.
(3) NO C2 REQUIRED OF AWACS.
(4) MISSION SLIPS ETC. TO BE COORDINATED THROUGH NELLIS COMMAND POST.

(C) SAFETY:

(1) F-4S WILL BE WITHIN ALTITUDE BLOCK ^LF200-230 WHILE IN THE RESTRICTED AREAS.
(2) F-4'S WILL MONITOR PRE-COORDINATED RADIO FREQUENCIES WHILE IN RESTRICTED AIRSPACES.
(3) NO TARGET EVASIVE/DEFENSIVE ACTIONS ARE AUTHORIZED.
(4) INTERCEPT ROE TO BE IAW JM 55-200.
(D) POINT OF CONTACT MAJ JERRY NARANCICH AV 682-2900/2901.

~~6. NAS MIRAMAR AGGRESSORS~~

(1) FOUR F-4 SINGLE SHIP RANDOM LAUNCHES (NO CLOSER THAN 10 MINUTES) FROM NAS MIRAMAR WITHIN FOLLOWING WINDOWS 130405Z-0830Z AND 140615Z-1030Z TO PROVIDE AGGRESSOR INTERCEPTORS AGAINST E-3A OR CAP BRAVO AIRCRAFT ON STATION AS LISTED IN THIS FRAG.
(2) SQUADRONS UTILIZE OWN FLIGHT SCHEDULE/STEREO ROUTING TO/ FROM W-289/290, T-03 MOUSE TRANSITION, RECOVER POINT W. CHECK IN/OUT BEAVER CONTROL NORTH SECTOR.
(3) WHILE IN W-289/290 AIRCRAFT REMAIN BELOW FL 280 AND OUTSIDE 5NM OF E-3A. INTERCEPTS WILL BE FORWARD QUARTER ONLY AND WILL BE SINGLE PASS ONLY.
(4) TAKEOFF TIMES TBD BY SQUADRONS INVOLVED TO PUT F-4'S INTO WARNING AREAS WITHIN PRESCRIBED BLOCK TIMES.
(5) F-4'S WILL MONITOR UNIFORM GUARD (243.0), PRIMARY TACTICAL/ 390.2, SECONDARY MONITOR AUX CH 3 (277.2). F-4'S TRANSMIT ON THESE FREQUENCIES ONLY IN THE INTEREST OF SAFETY. MODE I IFF 61, MODE II 6100, MODE III 61XX.
(6) SAFETY. F-4'S WILL MAINTAIN ALTITUDES AS LISTED ABOVE. NO EVASIVE MANEUVERS AUTHORIZED. MONITOR ABOVE COMM FREQUENCIES AS LISTED ABOVE. POC LCDR L. A. CLABAUGH AV 959-2211/3381.
PART THREE: (S) COMMAND AND CONTROL: THE MISSION COMMANDER WILL BE ON BOARD THE E3A DURING THE ON STATION TIMES. WHEN THE E3A IS NOT ON STATION THE EXERCISE COORDINATOR AT PLEAD CONTROL, POINT MUGU NAS WILL BE THE TEST CONTROL POINT. ALL PARTICIPATING UNITS WILL CALL PLEAD CONTROL AT AUTOVON 351-7315 TO PASS TAKEOFF TIMES, DELAYS, OR ABORTS. UNITS WILL CALL PLEAD CONTROL NLT 122300Z WITH A UNIT CONTACT PHONE NUMBER FOR EXERCISE BACK CHANNEL INFORMATION.
PART FOUR: (S) COMMUNICATIONS: ALL RADIO COMMUNICATIONS WITH THE E-3A WILL BE CONDUCTED VIA SECURE VOICE. FREQUENCY DESIGNATORS WILL BE USED. ACTUAL FREQUENCIES WILL NOT BE ANNOUNCED

PAGE 3

~~SECRET~~

00001001

DEPARTMENT OF DEFENSE

JOINT CHIEFS OF STAFF

MESSAGE CENTER

PAGE 4
IN THE CLEAR.
(A) (U) FREQUENCIES

~~SECRET~~

2534

BT
44122
ANNOTES
CLH

PAGE 4

~~SECRET~~

00001001

NNNN
091722Z

YZCZCJRL070
PS4768
PACS

~~SECRET~~

ZYUW

2534
SECT 05 OF 02534

ACTION

J3(05)

DISTR

OPR CJCS:(02) CJCS DJS(01) SJCS(01) FILE
(009)

TRANSIT/091705Z/091720Z/000:23GRP0921
DE RUEKJCS #4123 2221728
ZNY SSSSS

O 091705Z AUG 80

FM JCS WASHINGTON DC//J3-SOD//

TO RUCIPBA/TAC LANGLEY AFB VA//DOA/DOOW//

RUCJAAA/USCINCRD MACDILL AFB FL

RUVOABA/552AWCW TINKER AFB OK//OO/CC/963/964//

RUWTEKA/HQ SAC OFFUTT AFB NE//DO/LG//

RHFIAAAA/22BMW MARCH AFB CA//DO/MA//

RUCVAAA/8AF BARKSDALE AFB LA//DO/LG//

RUMFEFA/307AREFG TRAVIS AFB CA//DO/MA//

RHFIAAAA/15AF MARCH AFB CA//DO/LG//

RUWTPGA/12AF BERGSTROM AFB TX//DO//

RUWJBMA/474TFW NELLIS AFB NV//DO//

RUWDVAA/COMFITAEXWINGPAC SAN DIEGO CA

RUWJOHA/COMATVAQWINGPAC NAS WHIDBEY WA

RUWDPAA/COMPACMISTESTCEN PT MUGU CA

RUWJBMA/57TTW NELLIS AFB NV/OA

BT

~~SECRET~~ 2534

SECTION 5 OF 5

(1) (C) LINK 4A (TADIL-C): THE FOLLOWING FREQUENCY WILL BE
USED FOR LINK 4A (TADIL C) DATA COMMUNICATIONS BETWEEN E-3A
AND FIGHTER AIRCRAFT. MAINTAIN ALTITUDES AS LISTED ABOVE.

PRI

DESIGNATOR

313.5 MHZ

C5

SEC

320.9 MHZ

A2

LINK 4 ADDRESSEES

HOPPY 1 03001

HOPPY 2 03002

HOPPY 3 03003

HOPPY 4 03004

(2) (U) UHF (SECURE VOICE/KY-28) NETS

GE 2

~~SECRET~~

2534

- 1. CAP ALPHA PRI 393.2 MHZ
SEC 360.1 MHZ
- 2. CAP BRAVO PRI 392.2 MHZ
SEC 360.1 MHZ
- 3. CAP CHARLIE PRI 394.2 MHZ
SEC 373.2 MHZ
- 4. REFUELING CONTROL PRI 283.5 MHZ
SEC 235.2 MHZ

AZ
LX
AZ
LX
YT
FX

SAC BOOM
LAX CENTER
) (C) HF (SECURE VOICE/KY-75)/WINDOW FREQS GIVEN, USB ALL.
E-3A TO E-3A (AIRSPACE) 7397.5 KHZ (PRI)
DESIGNATOR - EH
COMMAND CONTROL HF BETWEEN E-3A AND PT MUGU. (SEC)

DESIGNATORS

PRI 11214.0 MHZ YH
SEC 6735.0 KHZ TH

) (S) SATELLITE UHF COMMUNICATIONS.
PRIMARY SECURE VOICE (PARKHILL) COMMAND CONTROL LINK BETWEEN THE
3A AND THE GROUND CONTROL ELEMENT (PLEAD CONTROL) WILL BE VIA
TELLITE.

294.4 MHZ UPLINK
260.8 MHZ DOWNLINK

SECONDARY COMMAND CONTROL COMMUNICATIONS WITH PLEAD CONTROL WILL
VIA UHF 325.6 MHZ.

(U) (S) CALL SIGNS:

E-3A AFKAI-L CHANGING CALL SIGNS
BLOCK AND LINE ZULU DAY
13 AUG 80

ZULU DAY
14 AUG 80

FLT CREW D0870

PRI KEMP 26
AIR SPARE KEMP 27

TON 26
TCN 27

MISSION CREW L0490

PRI CUB BEAR INDIA
AIR SPARE CUB BEAR JULIET
SAC KC-135 GRIM 11 THRU 15

FOSTER INDIA
FOSTER JULIET
TWIN 11 THRU 15

NAVY F-14 HOPPY 1, 2, 3, 4

K/A-6 MILESTONE 501, 502, 521, 522, 523

552 AWACW COMMAND POST - RAYMOND 24, AV 735-7313

GROUND CONTROL ELEMENT - PLEAD CONTROL. AV 351-7315

(U) COMSEC MATERIALS.

(1) (S) THE FOLLOWING KEYLISTS WILL BE USED FOR SECURE VOICE:

(A) UHF (NEWTOR) - USKAK 8098

GE 2

~~SECRET~~

00001001

~~SECRET~~

AGE 3

~~SECRET~~

2534

(B) HF (PARKHILL) - USKAT 218

(C) SATELLITE LINK (PARKHILL) - USKAT 216

(2) (U) THE FOLLOWING OPS CODE AND AUTHENTICATOR WILL BE USED IN THE EVENT SECURE VOICE FAILS:

(A) OPS CODE AKAC 132.

(B) AUTHENTICATION AKAC 874.

A (3) (S) CHANGE OVER TIME FOR ALL COMSEC MATERIAL IS [REDACTED] EXCEPT FOR USKAK [REDACTED] CHANGE-OVER TIME FOR USKAK [REDACTED] IS [REDACTED] TO THE NEXT RADAY. (EXAMPLE: AT [REDACTED] GO TO NEXT RADIO DAY KEYLIST I.E., DAY 13 EFFECTIVE)

• COORD FOR RANGE COMMUNICATIONS EQUIPMENT WAS DONE THROUGH 552 WACW/DOK AND TEST RANGE MANAGEMENT DIVISION CODE 3270.

ART FIVE; (S) REPORTS: J-STAFF TO DETERMINE.

CS/J-3 POC MAJOR PAT NANCE, AV 225-5905/55078/72231.

• LOS ANGELES CENTER COORDINATOR WILL BE CAPT JACK SLAGLE, AUTOVON 898-1290

• REPORTS:

1. FIRST NIGHT DEBRIEF. FIRST NIGHT ACTIVITY DEBRIEF WILL BE CONDUCTED TELEPHONICALLY BY FLIGHT LEADERS AS SOON AS PRACTICABLE FOLLOWING LANDING. THIS DEBRIEF WILL BE CONDUCTED TELEPHONICALLY WITH THE TINKER COMMAND POST DUTY OFFICER. (AUTOVON 735-7313/ TINKER SECORD 13 DROP 23). THE FOLLOWING FORMAT WILL BE USED:

CALL SIGN:

TYPE AIRCRAFT:

TAKE-OFF/LANDING TIME (ZULU):

DEVIATION FROM PLANNED MISSION:

REMARKS:

2. HOT WASH-UP. HOT WASH-UP WILL BE CONDUCTED AT MIRAMAR NAS FOR ALL NAVY FLIGHT LEADERS ON 14 AUG AT 1400 HRS IN ROOM 214, BLDG 256 (ENTER FROM CFAWP SPACES). HOT WASH-UP FOR E-3 AIR CREWS WILL BE CONDUCTED AT TINKER AFB ON 15 AUG AT 0900Z, D.O. CONFERENCE ROOM, BLDG 292. AGGRESSOR AND KC-135 FORCES ARE AUTHORIZED TO DEBRIEF TELEPHONICALLY IN ACCORDANCE WITH PROCEDURES AND FORMAT OUTLINED FOR THE FIRST NIGHT'S ACTIVITY. OTHER FORCES WILL PROVIDE REPRESENTATION AT EITHER OF THE HOT WASH-UPS.

3. AFTER ACTION REPORT. JCS/J-3 WILL PREPARE THE AFTER ACTION REPORT. INPUTS WILL BE GATHERED AT THE HOT WASH-UP SESSION. DETAILED FLIGHT PROFILES TO INCLUDE FUEL CONSUMPTION DATA WILL BE REQUIRED. PERSONNEL SHOULD REVIEW EXERCISE OBJECTIVES AND BE PREPARED TO PROVIDE INFORMATION RELATIVE TO THE REQUIRED EVALUATION. EMPHASIS WILL BE PLACED UPON IDENTIFICATION OF OPERATIONAL PROBLEM AREAS, ANY EQUIPMENT REQUIREMENTS, AND LESSONS LEARNED.

DECL 8 AUG 1986

AGE 3

BT

CLH

~~SECRET~~

00001001

~~SECRET~~

CONFIDENTIAL



CONFIDENTIAL

SECRET

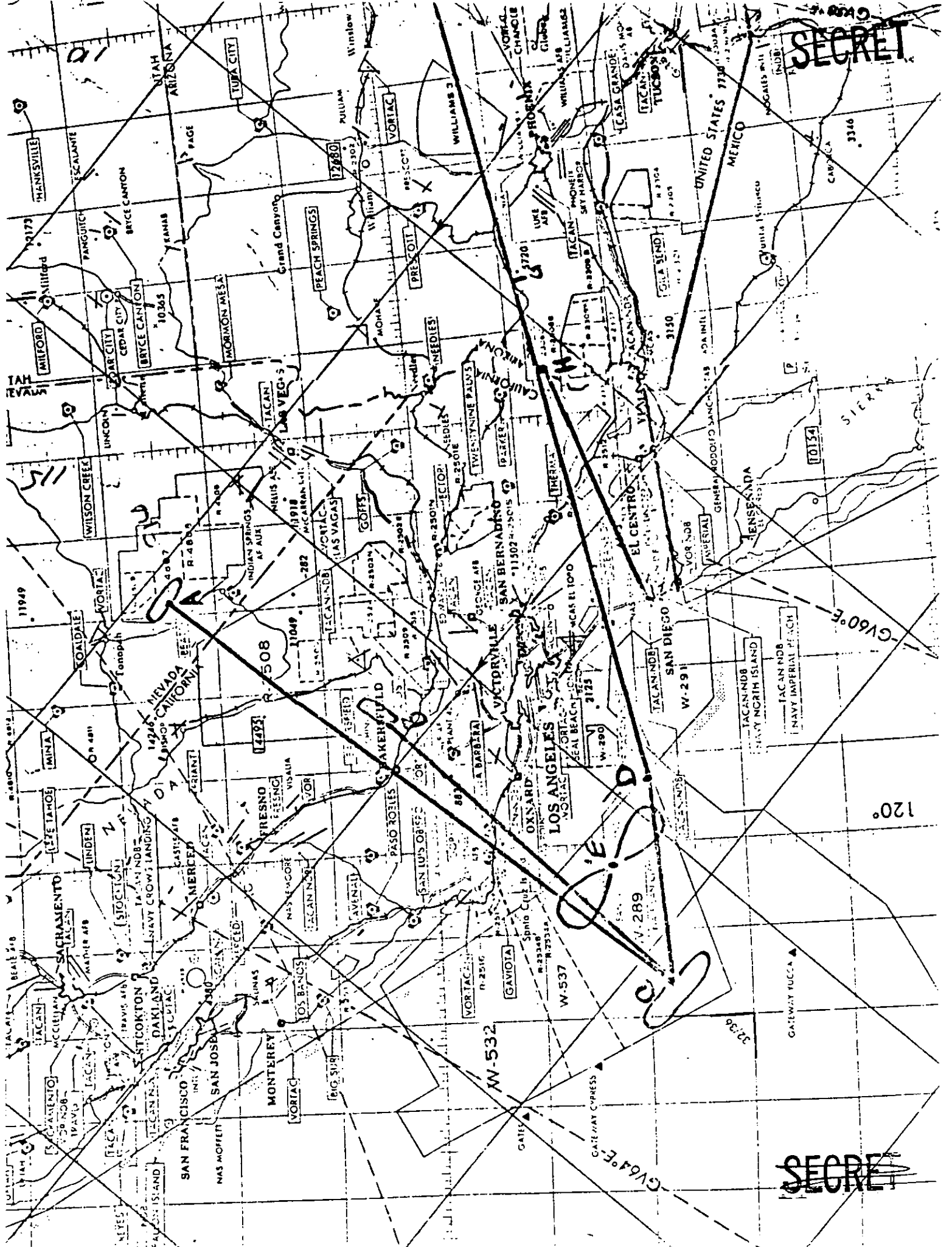

SECRET



~~SECRET~~
THE JOINT CHIEFS OF STAFF
WASHINGTON, D.C. 20301

THE JOINT STAFF

20 October 1980

MEMORANDUM FOR DISTRIBUTION

Subject: E-3A/F-14 (POISON DART) Coordination Exercise
After Action Report (U)

The enclosed after action report is forwarded for your information.

W. A. GURECK
Rear Admiral, USN

Enclosure
a/s

DISTRIBUTION:

Joint Test Directorate
CINCPAC (RADM E. Martin)
COMFITAEWINGPAC
552 AWACW

CLASSIFIED BY JCS, J-3, JTD
REVIEW ON 20 OCTOBER 2000
EXTENDED BY JCS, J-3, JTD
REASON 5200.1R, PAR 2-301c (5)

WHEN ENCLOSURE IS DETACHED
THIS DOCUMENT IS DOWNGRADED
TO UNCLASSIFIED

~~SECRET~~

~~SECRET~~

1. (U) Purpose. The purpose of this exercise was to increase contingency capabilities of rapid reaction forces, to conduct a comprehensive readiness evaluation of the E-3A/F-14 weapons system, and to evaluate the command and control of integrated air, ground and naval elements in a simulated hostile environment.

2. (U) Objectives. Exercise objectives included:

- a. Evaluate/refine F-14/E-3A air superiority, aggressor/suppression and airfield neutralization operations at long distances from home bases.
- b. Refine E-3A to F-14 one-way link 4A command and control procedures to include an expanded utilization code.
- c. Evaluate E-3A AWACs capability to assist in overall mission command and control.
- d. Evaluate IFF integrity and secure communications.
- e. Evaluate mission rollback procedures.

3. (U) Poison Dart E-3A/F-14 Exercise Participants. The following units participated in the exercise:

- a. 552 AWACW provided one E-3A/SENTRY (with a ground spare) operating out of Tinker AFB.
- b. COMFITAEWWINGPAC provided six F-14/TOMCAT fighters operating out of NAS Miramar.
- c. 474 TFW provided four F-4D/PHANTOM sorties for aggressor tracks from Nellis AFB.
- d. 49 TFW provided four F-15/EAGLE sorties for aggressor tracks from Holloman AFB.
- e. HQ SAC provided KC-135 support for E-3A/SENTRY and F-14/TOMCAT refueling.

4. (U) Concept of Operations. The concept of operations was to:

- a. Operate air-to-air configured F-14 aircraft at extreme distances from a simulated aircraft carrier home base

in an air superiority/airfield suppression role under control of an E-3A AWACS.

- b. Operate E-3A and F-14 in a high threat environment over a simulated enemy's airspace and protect high value aircraft from fighter attack.
- c. Operate tankers (KC-135) with fighter cover over simulated enemy's airspace.

5. (U) Planning. Planning for the E-3A/F-14 portion of POISON DART commenced on 16 September with a preliminary planning conference at Hurlburt AFB. JTD representatives also visited the 552 AWACW on 17 and 18 September to provide guidance. A draft frag order was prepared and presented at a 20 September brief-back at Hurlburt. The frag order was disseminated from Washington to participants on 24 September.

6. (U) Exercise Narrative. Significant exercise events are listed as follows (all times Zulu on 28 September):

- a. 0400 - One E-3A (Exile 25) launched from Tinker AFB en route the exercise area.^{1/}
- b. 0530 - E-3A refueled using standard procedures (no zip-lip).
- c. 0630 - Six F-14's (Blade 1-6) launched from NAS Miramar en route CAP stations and rendezvous with E-3A and tankers.
- d. 0715 - Six F-14's commenced refueling from KC-135. KC-135 did not use zip-lip procedures called for in the exercise frag order.
- e. 0720 - Blade 2 (with 4 exercise Phoenix missiles) could not stay in the basket at 25,000 feet, 270 KIAS. Suspect angle of disconnect caused F-14 fuel probe nozzle separation which jammed the KC-135 basket. Blade 2 returned to NAS Miramar and KC-135 returned to base. Remaining F-14's vectored to AR 602 for rendezvous with another tanker.

^{1/} Because of weather, POISON DART was conducted on two nights vice one as originally scheduled. Accordingly, only one E-3A was launched on the first night; a ground spare was prepared in the event the primary aircraft was not operational.

- f. 0725 - E-3A attempting to scramble next tanker; lack of direct communications with KC-135 players results in some confusion.
 - g. 0845-0945 - Five F-14's refueled in vicinity of AR 602.
 - h. 0930 - E-3A on station in orbit area.
 - i. 0945 - F-14 vectored to CAP stations.
 - j. 1006-1206 - Aggressor window. Four F-4 sorties from Nellis AFB and four F-15 sorties from Holloman AFB. All aggressors played and some recycled after first run.
 - k. 1215 - Rollback ordered. No high altitude tanker available. Blade 3, 4, and 6 proceeded direct to NAS Miramar. Blade 1 and 5 diverted to Kirtland AFB for fuel prior to return to NAS Miramar.
 - l. 1400 - E-3A recovers at Tinker AFB.
7. ^(U)~~(S)~~ Results:
- a. Aircraft availability: All E-3A and F-14's were full mission capable on takeoff.
 - b. Air superiority operations:
 - (1) All aggressor aircraft were detected at launch--IFF and skin paints were detected on all.
 - (2) Firing positions were achieved on all aggressor sorties and recycle runs except for one.
 - (3) Successful aggressor penetration was due in part to the following factors:
 - (a) Confusion in refueling CAP station.
 - (b) One fighter short. (Blade 2 returned to Miramar after damaging refuel probe)
 - (c) E-3A turned into bogey during intercept.
 - (d) Tentative air control procedures.
 - (4) There was some delay in vectoring F-14 after initial refueling in AR 602.

c. Tanker operations:

- (1) Early F-14/tanker operations were not conducted by KC-135 as briefed. Zip-lip procedures were not used as directed in frag order.
- (2) There was no airborne KC-135 spare to replace active tanker when refueling basket was damaged.
- (3) KC-135 not briefed to automatically climb out of weather during refueling operations.
- (4) Refueling operations during aggressor window were sometimes confused--contributed to success of one aggressor aircraft.
- (5) There was no tanker available at end of exercise period which resulted in two diverted F-14's.

d. Command and Control:

- (1) Only one F-14 able to receive TADIL C (Link 4A). Link 4A control and utilization code was not tested.
- (2) KY-28-covered UHF nets did not work between E-3A and F-14's although F-14's could talk to each other and E-3A could talk to KC-135's.
- (3) All CAP control conducted on uncovered UHF nets as a result of (1) and (2) above.

e. Mission Duration: All F-14 aircrews noticed signs of fatigue after about four hours. Consensus of crews was that a daylight carrier recovery would have been possible after the mission.

8. ^(U)~~(S)~~ Conclusions and Recommendations:

Conclusion:

- a. The inability to establish Link 4A and secure UHF resulted in degraded command and control. Only one F-14 was able to receive Link 4A. All F-14's checked with ground beacon at takeoff. However, Link 4A address was not set correctly on at least two F-14's in accordance with the Frag order. There was no check-in/set-up procedure once join-up made with E-3A (E-3A should initiate). Reason for non inter-operability of KY-28 comms is unknown. CEOI was not provided to COMFITAEWINGPAC.

Recommendation:

- a. Devise TADIL C SOP for ground set-up and airborne check-out; include compulsory ground check of TADIL C address in F-14 avionics bay. Investigate feasibility of making TADIL C/Link 4A a two-way link. All participants must receive CEOI early enough to insure familiarity. We must reduce unnecessary net chatter by briefing each of the participants and by setting a silent example. Conduct short duration F-14/E-3A coordination exercises prior to next full scale training exercise.

Conclusion:

- b. The high altitude tanker plan was neither planned completely nor executed smoothly. There was no airborne tanker spare for each critical refueling evolution. There was no direct comm link to tanker bases on which to direct a timely tanker scramble. Too few tankers were planned for F-14 refueling. Tanker crews did not use pre-briefed frequencies for initial F-14 refueling nor did they use zip-lip procedures. Tanker crews were not briefed to change altitude if weather was below F-14 refueling minimums. The F-14 cannot refuel at full military power at FL250 with four Phoenix missiles aboard and near full fuel weight.

Recommendation:

- b. Tighten up tanker planning. JTD should have a cleared KC-135 planner on the staff. Liaison with SAC planner must be closer. Frag order must include dedicated net for E-3A to tanker base coordination. Frag order should include provisions for both airborne spare and deck alert tanker. Review and insist on zip-lip procedures on next exercise. Tanker plan must include option to automatically climb out of weather. Future planning must include option to slow tanker to 200 KIAS and climb to FL310 if fighters are near full fuel weight.

Conclusion:

- c. Control of fighters (without use of Link 4A) was tentative. Air Force and Navy procedures are not the same and confusion did exist.

Recommendation:

- c. Increase liaison between F-14 and E-3A mission crews to exchange and refine air intercept control procedures.

OSCA SUMMARY SHEET

TO: J-30	CLASSIFICATION SECRET	FOR USE BY ORIGINATING DIRECTORATE		
THRU:		DJSM NO.	DDJS SUSPENSE DATE	
SUBJECT: Exercise POISON DART E-3A/F-14 PRAG ORDER (U)	DJSM DATE			
	ACTION			
	APPROVAL	SIGNATURE	INFORMATION	OTHER
	X	X		

REMARKS

1. (S) Exercise POISON DART, an exercise associated with the Joint Test Directorate will be conducted in the Western United States 27-28 September 1980.
2. (S) The facing message contains the Prag Order for the participating E-3A/F-14 aircraft.
3. (U) Recommend approval and signature.

3

ACTION OFFICER LtCol, USMC E-3, JTD Ext 55078	COORDINATION/APPROVAL					
	OFFICE	NAME	EXTENSION	OFFICE	NAME	EXTENSION
	JTD	<i>[Signature]</i>	55078			
	J-33					
	J-31					
DATE OF PREPARATION 23 Sep 1980	SECRET					

01 22

241746z

00

JCS WASHINGTON DC//J3//
 HQ SAC OFFUTT AFB NE//DO//LG//
 USCINCRCD MACDILL AFB FL
 TAC LANGLEY AFB VA//DCA//D00W//
 12AF BERGSTROM AFB TX//DO//
 15AF MARCH AFB CA//DO//LG//
 552 AWACW TINKER AFB OK//CC//DO//963//
 228MW MARCH AFB CA//DO//MA//
 288MW ELLSWORTH AFB SD//DO//MA//
 968MW DYESS AFB TX//DO//MA//
 COMFITAELWINGPAC SAN DIEGO CA
 474TFW NELLIS AFB NV//DO//
 49TFW HOLLOMAN AFB NM//DO//

~~SECRET~~

SUBJ: FRAG ORDER FOR POISON DART E-3A/F-14 EXERCISE (U)

PART I

(U)
 SUMMARY: COUNTRY KILOGRAM, IN THE WESTERN PORTION OF THE US, IS
 HOSTILE AND MILITARY ACTION REQUIRING AIR COVER IS TO BE UNDERTAKEN.
 RESISTANCE FROM GROUND AND AIR RESOURCES IS ANTICIPATED. END SUMMARY.

CJCS DJS SJCS J3 SOD

LTCOL, USMC

J3, SOD, EXT 55078, 23 SEP 80

~~SECRET~~

1. ~~(S)~~ ^(U) OBJECTIVES - THE PURPOSE OF THIS EXERCISE IS TO INCREASE CONTINGENCY CAPABILITIES OF RAPID REACTION FORCES, CONDUCT A COMPREHENSIVE READINESS EVALUATION OF REACTION FORCES, AND EVALUATE THE COMMAND AND CONTROL OF INTEGRATED AIR, GROUND AND NAVAL ELEMENTS IN A SIMULATED HOSTILE ENVIRONMENT.

2. ~~(S)~~ PARTICIPANTS: 522 AWACW, COMFITAEMWINGPAC, 228MW, 288MW, AND 988MW SUPPORT.

~~(S)~~ TASKING:

A. ~~(S)~~ ^(U) 522 AWACW. PROVIDE ONE PRIMARY AND ONE SECONDARY E-3A TO BE ON STATION AS REQUIRED FOR RADAR SURVEILLANCE, F-14 CONTROL, ASSISTANCE IN COMMAND AND CONTROL BATTLE MANAGEMENT, FUEL MANAGEMENT AND SAR.

B. ~~(S)~~ ^(U) COMFITAEMWINGPAC PROVIDE TWO F-14 FOR CAP STATION A, TWO F-14 FOR CAP STATION B, TWO F-14 FOR CAP STATION C. REMAIN ON STATION UNTIL WITHDRAWALS, ANTICIPATE 8-HOUR MISSION DURATION.

C. ~~(S)~~ ^(U) 474 TFW. PROVIDE FOUR F-4 AGGRESSOR SORTIES TO SIMULATE ATTACKS STARTING AT LAKE POWELL, UTAH, TO DURANGO, CO, THEN TO THE AWACS PRIMARY ORBIT.

~~SECRET~~

D. (u) 49 TFS. PROVIDE 4 F-15 SORTIES TO SIMULATE ATTACKS ON E-3A PRIMARY ORBIT, DURANGO, CO AND/OR CAP CHARLIE.

E. (u) HQ SAC. PROVIDE KC-135 SUPPORT FOR E-3A AND FIGHTER REFUELING. F-14S REQUIRE SUFFICIENT REFUELING TO MAINTAIN COMBAT PACKAGES.

PART II OPERATIONS:

A. (u) GENERAL:

B. (u) CONCEPT OF OPERATIONS: SIX F-14 FIGHTERS ON CAP STATIONS AT THE FOLLOWING POSITIONS:

(A) TWO F-14S (AIR-TO-AIR CONFIGURED) 3530N 10900W TO 3600N 10500W CAP STATION ALPHA.

(B) TWO F-14S (AIR-TO-AIR CONFIGURED) 3300N 10735W TO 3333N 10709W CAP STATION BRAVO.

(C) TWO F-14S (AIR-TO-AIR CONFIGURED) 3424N 11317W TO 3408N 10440W CAP STATION CHARLIE.

(D) PRIMARY E-3A WILL ORBIT AN AREA DEFINED BY 3308N 10915W, 3400N 10915W, 3400N 10735W, AND 3308N 10735W. SECONDARY E-3A WILL ORBIT AN AREA DEFINED BY 3314N 11034W, 3742N 11022W, 3837N 10857W, AND 3805N 10845W.

~~SECRET~~

2. (u) F-14S ARE TO MAINTAIN COMBAT PACKAGES AS FOLLOWS:

CAP ALPHA 8300 LBS

CAP BRAVO 7200 LBS

CAP CHARLIE 4000 LBS

3. (u) MISSION OF CAP ALPHA: ENGAGE ANY SIMULATED ENEMY FIGHTER OR, AS DIRECTED BY AWACS, INSURE AGGRESSOR SUPPRESSION FROM NORTHERN AGGRESSOR AIRFIELD. REFUEL AS NECESSARY TO MAINTAIN COMBAT PACKAGES. CAP ALPHA PRIMARY AREA OF INTEREST IS LAKE POWELL.

4. (u) MISSION OF CAP BRAVO: ENGAGE ANY SIMULATED ENEMY FIGHTERS OR, AS DIRECTED BY AWACS, INSURE AGGRESSOR SUPPRESSION FROM SOUTHERN AGGRESSOR AIRFIELD. REFUEL AS NECESSARY TO MAINTAIN COMBAT PACKAGE. PRIMARY AREA OF INTEREST IS HOLLOMAN AFB.

5. (u) MISSION OF CAP CHARLIE: PROTECT TANKERS IN VICINITY OF REFUELING TRACK, ACT AS AIRBORNE SPARES FOR CAP A/B, AND PROTECT INTERIM OR FINAL ROLLBACK. REFUEL AS NECESSARY TO MAINTAIN COMBAT PACKAGE. PRIMARY AREA OF INTEREST IS HOLLOMAN AFB.

6. (u) MISSION OF E-3A: REFUEL EN ROUTE, ARRIVE ON STATION AS CAP A/B INGRESS AND ASSUME STATION. E-3A WILL BATTLE MANAGE ALL POISON DART AIRCRAFT ABOVE 15,000 FEET EXCEPT AGGRESSOR FORCES.

~~SECRET~~

7. (U) MISSION OF KC-135: REFUEL F-14 AND F-15 AS REQUIRED.

8. (U) MISSION OF OPPOSITION FIGHTERS: AIR FORCE F-4 AND F-15 (SIMULATING F-14S) WILL REACT TO MISSION AIRCRAFT FLYING ROUTES OVER DESIGNATED GROUND TARGETS.

B. (U) MISSION PROCEDURES:

1. (U) AWACS OPS: 552 AWACS WILL PROVIDE E-3A BATTLE MANAGEMENT AIRCRAFT TO EXERCISE NAVY F-14/AIR FORCE E-3A COORDINATION PROCEDURES. SPECIFIC TASKS:

(A) EVALUATE E-3A AWACS CAPABILITY TO ASSIST IN OVERALL MISSION COMMAND AND CONTROL.

(B) EVALUATE F-14/E-3A AIR SUPERIORITY, AGGRESSOR SUPPRESSION AND AIRFIELD NEUTRALIZATION, INSIDE AND OUTSIDE E-3A RADAR RANGE.

(C) REFINE E-3A TO F-14 ONE-WAY LINK 4A PROCEDURES TO INCLUDE AN EXPANDED UTILIZATION CODE.

(D) EVALUATE IFF INTEGRITY AND FM SECURE.

(E) EVALUATE E-3A ABILITY TO ASSIST DURING ROLLBACK.

(F) E-3A NARRATIVE: TWO E-3A WILL DEPART TINKER AFB, BACKUP

~~SECRET~~

06 22

00

AT ~~0401Z~~ ^{0401Z} AND PRIMARY AT ~~0401Z~~ ^{0401Z} 28 SEP REFUELING IN AN 314. AFTER REFUEL BOTH PROCEED TO HANKSVILLE VORTAC, ETA BACKUP 0736Z, ETA PRIMARY 0336Z. AT HANKSVILLE BACKUP E-3A PROCEED DIRECT TO ORBIT, PRIMARY E-3A PROCEED TO 33-30N 110-35W ETA 0925Z. F-14 (BLADE B) WILL JOIN PRIMARY E-3A AT 35-40N 110-34W AT 0908Z AND ESCORT E-3A TO ORBIT AREA, ETA 0937Z. ON ARRIVAL E-3A ORBIT AREA, BLADE B WILL CONTINUE TO CAP STATION B. E-3A WILL REMAIN ON STATION UNTIL 261700Z.

2. (U) F-14 OPERATIONS: EVALUATE F-14/E-3A COORDINATION PROCEDURES, LONG-RANGE F-14 CAP CAPABILITIES AND F-14 CREW CAPABILITY TO SUSTAIN LONG DURATION MISSION.

(A) ASSETS REQUIRED:

(1) 6 F-14A PRIMARY/EACH SQUADRON PROVIDE OWN SPARE.

(B) F-14 CONFIGURATION:

(1) 2PH, 2SP, 2SW, PLUS ANCILLARY EQUIPMENTS; IF NO PH AVAIL, LOAD 2PH RAILS.

(2) APX-076, OPERATE LINK 4A and MARK XII (MODE IV CAPABLE) IFF.

~~SECRET~~

{3} EXERCISE FUEL TANKS AND AUXILIARY EQUIPMENT.

{4} FUNCTION/AFSC.

{5} KY-28.

{6} UHF/ICF RECORD CAPABILITY.

(U)
{7} REQUIREMENTS:

{1} WAIVER OF EXT FUEL TANK RESTRICTION.

{2} AIRCREWS REQUIRE NIGHT KC-135 QUALIFICATION
PRIOR TO START OF MISSION.

{3} FULLY OPERATIONAL IFF. SQUAWK ASSIGNED MODES AND
CODES AS PER PART II PARA 6{2}.

{4} OPERATIONAL KY-28S.

{5} F-14 MISSION NARRATIVE:

{1} 6 F-14 LAUNCH FROM NAS MIRAMAR AT 0620Z AND PROCEED
TO AR-3-H (EAST) ARIP (EED VORTAC) TO ARRIVE AT 0652Z. PROCEED
TO ARCP (EED 062/100NM) TO RENDEZVOUS WITH KC-135. FIRST FLIGHT
{4 ACFT} REFUEL TO TOP OFF {20,000 LB} ON AR TRACK, THEN DEPART
EXIT POINT (EED 062/280NM) NLT 0800Z, FOR AR-602 AREA.
RENDEZVOUS WITH AR-602 TANKER, STAND BY FOR FUEL WARNING CALL FROM

08 22

00

~~SECRET~~

CAP A, B AS SIGNAL TO TOP OFF, THEN RELIEVE CAP A, B ON STATION. ARRIVE AT CAP A, B AND ESTABLISH MAX ENDURANCE HOLDING ORIENTED TO COVER THREAT SECTORS AS PREBRIEFED.

(2) SECOND FLIGHT (2 ACFT) WILL TANK TO 20,000 LB, WESTBOUND ON AR-3-H RETURN LEG. FLIGHT TWO LEAD PROCEED TO CAP A WHEN CLEARED. FLIGHT TWO WING PROCEED WITH E-3A AND DETACH TO CAP B WHEN CLEARED.

(3) CAP STATION	COMBAT PACKAGE	WARNING CALL
A	8000 LB	13600 LB
B	7000 LB	11400 LB
C	4000 LB	NOT REQUIRED

CAP STATION A, B WILL MAKE A WARNING CALL UPON REACHING ABOVE FUEL STATE. HOWEVER, E3A SHOULD NORMALLY INITIATE REFUELING SWITCH VIA LINK 4. RELIEVING F-14 IN AR-602 SHOULD TANK TO 20000 LB AND PROCEED TO DESIGNATED CAP STATION. COMBAT PACKAGE ASSUMES FUEL REQUIRED BY CAP AIRCRAFT TO TRANSIT FROM CAP STATION TO AR-602 ARRIVING ON TANKER WITH 4000 LB. TRANSIT TIME FROM CAP A TO AR-602 IS 0 PLUS 43 MIN. TRANSIT TIME FROM

~~SECRET~~

04 22

00

CAP B TO AR-602 IS 0 PLUS 32 MIN. WARNING CALL ASSUMES AMOUNT OF FUEL BURNED BY CAP AIRCRAFT FROM TIME OF WARNING FUEL CALL TO RELIEF BY ONCOMING F-14, INCLUDING RELIEF AIRCRAFT TIME TO TANK AND TRANSIT TO CAP STATION. CAP AIRCRAFT WILL ADJUST AREAS OF INTEREST (ENEMY) DURING CHANGE OF POSITION.

{4} F-14S WILL UTILIZE FL 250 FOR ROUTE TO AR-3-H (EAST), INCLUDING TANKING. USE FL 330-350 ON CAP STATION A, B. FLIGHT ONE ENTER AR-602 AT FL 250. ALL SUBSEQUENT AIRCRAFT ENTER AT FL 330-350. DO NOT PROCEED BELOW FL 330 UNTIL CLEARED BY E3A.

{5} AIRCREWS UTILIZE LINK 4A AS PRIMARY MEANS OF COMMAND AND CONTROL. TANK USING NO-RADIO RDVZ AND TANKING PROCEDURES. UHF COMM USING SECURE VOICE OR CLEAR UHF IF REQUIRED.

{6} EXPECT MISSION ROLLBACK TO BEGIN AFTER 1236Z. BINGO PACKAGE FROM AR-602 TO NAS MIRAMAR WITH 2500 LB RESERVE IS 13000 LB AT ROLLBACK, AIRCREWS CONTACT ARTCC REQUEST INS CLEARANCE PRESENT POSITION, DIRECT TO NAS MIRAMAR.

3. (U) AGGRESSOR OPERATIONS - AGGRESSOR FORCES WILL FOLLOW THE GUIDANCE PROVIDED IN THIS FRAG AND WILL NOT DEVIATE FROM BRIEFED

~~SECRET~~

PROCEDURES. AGGRESSORS WILL FILE FLIGHT PLANS WITH A MINIMUM 20 MINUTE SEPARATION BETWEEN AIRCRAFT LAUNCHES.

{A} ASSETS REQUIRED:

{1} 49TFW (HOLLOMAN AFB, TX) WILL PROVIDE 4 F-15 AIRCRAFT. IF FUEL AVAILABLE AIRCRAFT MAY RECYCLE FROM HOLLOMAN.

{2} 474TFW (NELLIS AFB, NV) WILL PROVIDE 4 F-4 AIRCRAFT. IF FUEL AVAILABLE AIRCRAFT SHOULD RECYCLE FROM LAKE POWELL START POINT.

{B} CONFIGURATION:

{1} ALL AGGRESSOR AIRCRAFT MUST HAVE A FULLY OPERATIONAL IFF AND OPERATE ON ASSIGNED MODES AND CODES. FOR ASSIGNED IFF MODES AND CODES REFERENCE PART II 6.6.3.

{C} REQUIREMENTS:

{1} AN AGGRESSOR ATTACK WILL ENTAIL ONLY MOVEMENT TOWARD THE TARGETS ASSIGNED. INTERCEPT OF AIRBORNE TARGETS WILL TERMINATE NO CLOSER THAN 5 NM. ONLY ONE PASS, NO HIGHER THAN FL 230, IS AUTHORIZED.

{2} REQUIRED SQUAWKS, AS PER PART II 6.6.2) MUST BE INCLUDED IN REMARKS SECTION OF DD FORMS.

(B) "POISON DART PARTICIPANTS" MUST BE ENCLOSED IN REMARKS SECTION OF DD 179.

(D) F-4 NARRATIVE:

(1) TAKEOFF TIME FOR NELLIS (SIMULATED) F-4 AGGRESSORS WILL BE ANYTIME BETWEEN 251000Z AND 251200Z WEP 80, NO CLOSER THAN 10 MINUTES APART. ROUTE OF FLIGHT WILL BE NELLIS TO LAKE POWELL (AS SIMULATED STARTING POINT) THEN VIA DURANGO, COLO, OR DIRECT TO PRIMARY E-3A (CENTER POINT OF ORBIT IS NEGRITO, NM).

(E) F-15 NARRATIVE:

(1) TAKEOFF TIME FOR HOLLOWAN F-15 AGGRESSORS WILL BE ANYTIME BETWEEN 281000Z AND 281200Z, BUT NO CLOSER THAN 10 MINUTES APART. ROUTE OF FLIGHT WILL BE HOLLOWAN TO DURANGO, COLORADO, OR TO CAP CHARLIE, OR DIRECT TO PRIMARY E-3A. (CENTER POINT OF ORBIT IS NEGRITO, NM) AGGRESSORS WILL BE ENGAGED BY F-14S UPON REACHING TARGET AREA. AGGRESSOR WILL MAKE ONE CALL IN BLIND: "CALLSIGN" OVER DURANGO CAP CHARLIE OR E-3A ORBIT.

(2) WHILE IN EXERCISE AIRSPACE, AGGRESSORS WILL REMAIN BETWEEN FL 200 AND FL 230, AND OUTSIDE 5 NM OF E-3A. CAP AIRCRAFT

WILL AVOID THIS BLOCK, PLUS OR MINUS 20000'. INTERCEPTS WILL BE FORWARD QUARTER ONLY AND WILL BE SINGLE PASS ONLY.

{3} AIRCRAFT WILL MONITOR UNIFORM GUARD (2243.0). TRANSMIT ON THIS FREQUENCY ONLY IN THE INTEREST OF SAFETY.

{4} NO AGGRESSOR EVASIVE/DEFENSIVE ACTIONS ARE AUTHORIZED.

{5} INTERCEPT ROE TO BE IAW JM 55-200.

4. TANKER SUPPORT: REQUEST SAC PROVIDE KC-135 AIR REFUELING SUPPORT FOR E-3A AND NAVY F-14 CAP SUPPORT. NAVY REFUELING TRAINING WILL BE CONDUCTED PRIOR TO MISSION IAW INTERSERVICE SUPPORT AGREEMENT.

{A} ^(U) ~~(S)~~ E-3A SUPPORT: CONCEPT OF OPERATIONS IS TO REFUEL 2 E-3A EN ROUTE, USING POINT PARALLEL RENDEZVOUS:

ARCT	AREA	ALT	RCVRS	OFFLOAD
0602Z	AR314W	FL250	1 E3A	22.5-25M
0732Z	AR314W	FL250	1 E3A	22.5-25M

C/R PLAN: AS PUBLISHED IN FLIP 1B

8. {S} F-14 INGRESS SUPPORT: CONCEPT OF OPERATIONS FOR DROGUE

13 22

00

~~SECRET~~

EQUIPPED KC-135 AIRCRAFT TO PROVIDE A/R SUPPORT FOR (5) F-14 AIRCRAFT EN ROUTE USING A/R TRACK 3HE. JOIN UP WILL BE CONDUCTED AT THE ARCP AT 0613Z WITH TANKERS AT FL250 AND RECEIVERS AT FL230. THE TANKERS WILL HOLD AT ARCP UNTIL ALL 6 F-14 AIRCRAFT ARE JOINED, THEN PROCEED ON TRACK. AT END OF TRACK, (4) F-14 WILL PROCEED TO ARB02 AT FL250 UNDER ATC CONTROL. THE REMAINING (2) F-14 WILL CONTINUE WITH KC-135 HEADING WEST ON AR TRACK. THE (2) F-14 WILL DROP OFF TANKER AFTER COORDINATION WITH E-3A CONTROL. TANKER WILL THEN RTB UNDER ATC CONTROL.

ARCT	AREA	ALT	RCVRS	OFFLOAD
0709	3HE	FL250	6/F-14	60M TOTAL

C/R PLAN AS PUBLISHED IN FLIP 1B WHICH FOLLOWS: T.O. 1-10-1-1-27.

AR TRACK 3HE IS DEFINED AS FOLLOWS:

ARIP: 34 DEGREES 46'N 114 DEGREES 28'W

ARCP: 35 DEGREES 09'N 112 DEGREES 29'W

EXIT POINT: 36 DEGREES 41'N 107 DEGREES 14'W

CONTROL AGENCY: ATC

FREQ: LAX 323.2

ALT: FL230 FL 250

~~SECRET~~

(U)
 C. (S) CAP SUPPORT: CONCEPT OF OPERATIONS IS FOR DROGUE
 EQUIPPED KC-135 AIRCRAFT TO PROVIDE AN ANCHOR FOR (S) F-14
 AIRCRAFT IN AR602. KC-135 AIRCRAFT WILL ENTER AND EXIT AT
 DESIGNATED POINTS IN THE ANCHORS. RECEIVERS WILL BE VECTORED
 FOR JOIN UP BY E-3A CONTROL.

C/R PLAN AS PUBLISHED IN FLIP IB WHICH FOLLOWS:

AIR REFUELING ANCHOR 602 IS DEFINED AS FOLLOWS:

ARIP: 3424N 10317W

ARCP: 3408N 10440W

EXIT POINT 34 DEGREES 11'N 103 DEGREE 19'W -- 33 DEGREE 40'N
 104 DEGREE 44'W

CONTROL AGENCY: E-3A

FREQ: SEE PARA 6

ALT: FL190

(U)
 D. (S) EXERCISE TANKER INFORMATION

	ARCT	TANKER	REC'VR	OFFLOAD
E-3A(S)	0602Z	MOORE 31	1 E-3A	22.5-25M
E-3A(P)	0732Z	MOORE 31	1 E-3A	22.5-25M

F-14 (NOTE 1)	0709Z	ADDER 21	6 F-14	SUM TOTAL
CAP "C" (NOTE 2)	0921-1026Z	10CA 11	F-14	64
	1026-1131Z	10CA 12	F-14	64
	1131-1236Z	10CA 13	F-14	12

NOTE (1): F-14 WILL JOIN UP WITH TANKER AT ARCP AND PROCEED DOWN TRACK. AT END OF TRACK (4) F-14 WILL DROP OFF AND (2) F-14 WILL PROCEED BACK UP TRACK AND TOP OFF. TANKER WILL BE UNDER ATC CONTROL.

NOTE (2): F-14 CAP AIRCRAFT WILL REFUEL WHEN NECESSARY AND BE CONTROLLED BY E-3A. TANKER WILL BE CONTROLLED BY E-3A ONCE TANKER IN AR 602.

E. (S) E-3A/KC-135 REFUELING PROCEDURES: 2 E-3A RECEIVERS AND 1 KC-135 TANKER.

1. REFUELING WILL BE ACCOMPLISHED IN AR 314W ARCT 0602Z/0732Z/. 20000 LBS OF FUEL WILL BE OFFLOADED TO EACH AIRCRAFT.

F. (U) COMM OUT REFUELING PROCEDURES:

1. E-3A/KC-135 REFUELING PROCEDURES: 2 E-3A RECEIVERS AND 1 KC-135 TANKER.

(A) REFUELING WILL BE ACCOMPLISHED IN AN 314W ARCT 0602/
0732Z: 20,000 LBS OF FUEL WILL BE OFFLOADED TO EACH AIRCRAFT.

(B) IF RADIO SILENCE AIR REFUELING IS TO BE ACCOMPLISHED
THE FOLLOWING PROCEDURES WILL BE USED:

{{1}} RENDEZVOUS WILL BE ACCOMPLISHED USING A COMMON
POINT AND TIME. THE TANKER AND RECEIVER WILL PLAN TO ARRIVE AT
THE ARIP ESTABLISHED DOWNTRACK AT ARCT-15 MINUTES. IN THE EVENT
EITHER TANKER OR RECEIVER ARRIVES EARLY OR EITHER ARRIVES LATE
THE AIRCRAFT ARRIVING FIRST WILL ESTABLISH A COUNTER-CLOCKWISE
HOLDING PATTERN AT THE ARIP. TANKER AND RECEIVER WILL BE IN A/A
TACAN WITH BEACON ON A MINIMUM OF 150NM FROM ARIP. TANKER
FREQUENCY 95Y, BEACON 2-1-1. RECEIVER FREQUENCY 32Y, BEACON 3/1.

{{2}} WHEN IN PRECONTACT POSITION STANDARD VISUAL
SIGNALS WILL BE USED IAW T.O. 1-10-1-27.

{{3}} DURING PERIOD OF DARKNESS PARA {{2}} ABOVE WILL
APPLY AND ADDITIONALLY THE FOLLOWING LIGHT SIGNALS WILL APPLY:

17 22

00

CONDITION	TANKER SIGNAL	RECEIVER SIGNAL
READY FOR CONTACT	BOOM EXTENDED	ROTATING BEACON OFF
OFFLOAD COMPLETE	FLASH DIRECTOR LIGHTS	SLIPWAY DOORS CLOSED
RECEIVER LEAD CLEAR	BOOM STOWED	ROTATING BEACON ON

OF TANKER

(2) F-14/KC-135 REFUELING PROCEDURES: 6 F-14/1 KC-135

(A) FIRST REFUELER WITH WINGMEN IN LEFT ECHELON WILL JOIN ON STARBOARD WING OF THE TANKER. SUBSEQUENT AIRCRAFT WILL MOVE TO RIGHT ECHELON OF PRECEDING AIRCRAFT AFTER REFUELING.

5. ~~(S)~~ TEST ROE:

A. UTILIZE IFF MODE 1/2 TO VERIFY CONTACTS. ENGAGE AS REQUIRED WITH FORWARD QUARTER WEAPONS ONLY. CONTACTS SATISFYING IFF/PROFILE REQUIREMENTS WHICH ARE ATTACKABLE WILL BE ENGAGED.

B. E-3A/F-14 LINK 4A UTILIZATION CODE AS FOLLOWS:

ALTITUDE	HEADING	SPEED	MEANING	RESPONSE
35,000	AS ASSIGNED	.75M	OPS NORMAL	FLY COMMAND HEADING
50,000	"	"	ROLL BACK	FLY COMMAND HEADING
				SQUAWK FLASH
60,000	"	"	CAP A	FLY TO CAP A

18 22

00

65,000	"	"	CAP B	FLY TO CAP B
70,000	"	"	GO TO TINKER	FLY COMMAND
				HEADING
75,000	090	"	NO TANKER ASSETS	NONE
			AVAILABLE AT	
			PRESENT TIME.	
75,000	270	"	NO TANKER ASSETS	NONE
			EXPECTED	
80,000	AS ASSIGNED	"	BANDITS AT ASSIGNED	SQUAWK
			HEADING. DO NOT	FLASH
			ENGAGE OR DISENGAGE	
85,000	"	"	ENGAGE BANDITS	FLY CMD
			ENGAGE AND KILL.	HEADING
				SQUAWK
				FLASH
90,000	"	"	ALERT-MSG FOLLOWS	STAND-BY FOR
				ADDITIONAL
				INFO

~~SECRET~~

AFTER TASK HAS BEEN ACKNOWLEDGED, COMMAND ALTITUDE WILL BE DROPPED AND ACTUAL ALTITUDES ENTERED.

6. ^(U) IFF/SIF AND COMMUNICATIONS: ALL RADIO COMMUNICATIONS WITH THE E-3A WILL BE CONDUCTED VIA SECURE VOICE.

A. LINK 4A (TABIL C) ADDRESSES:

F-14 CALL SIGN	ADDRESS
BLADE 1	02101
BLADE 2	02102
BLADE 3	02103
BLADE 4	02104
BLADE 5	02105
BLADE 6	02106

B. IFF/SIF MODES AND CODES:

F-14 CALL SIGN	MODE I	MODE II	MODE III
BLADE 1	21	2101	2101
BLADE 2	21	2102	2102
BLADE 3	21	2103	2103
BLADE 4	21	2104	2104

~~SECRET~~

BLADE 5 21 2105 2105

BLADE 6 21 2106 2106

F-4 CALL SIGN		MODE I	MODE II	MODE III (NOTE 1)
TBD BY	1	61	6121	6121
AGGRESSOR	2	61	6122	6122
FORCE	3	61	6123	6123
	4	61	6124	6124

F-15 CALL SIGN		MODE I	MODE II	MODE III
TBD BY	1	71	7121	7121
AGGRESSOR	2	71	7122	7122
FORCE	3	71	7123	7123
	4	71	7124	7124

NOTE 1: THE F-4 WILL SQUAWK THESE MODE III CODES
AT IP LAKE POWELL.

C. EXTRACT OF DRAFT CEOI PROVIDED AS FOLLOWS:

{1} E-3A/F-14 AIR OPERATIONS NETS

CAP CONTROL UHF SECURE

PRIMARY: 258.0 KP

ALTERNATE: 327.2 KV

CAP INTERNAL INTER-AIR - UHF SECURE

PRIMARY: 357.2 EL

LINK 4A (TADIL C) DATA

PRIMARY: 278.2 CX

GUARD: 243.0

CALL SIGNS:

E-3A'S - EXILE, EXILE ALPHA

E-3A MISSION CREW - HANDCUFF, HANDCUFF ALPHA

F-14'S - BLADE (1 THRU 6)

{2} HIGH ALTITUDE AIR REFUELING OPERATIONS:

PRIMARY: 233.6 KN

ALTERNATE: 298.8 NR

TANKER TACAN TRANS: 95Y

TANKER TACAN RECEIVE: 32Y

~~SECRET~~

22 22

00

~~SECRET~~

CALL SIGNS:

KC-135 LIMIT

E-3A EXILE

F-14 BLADE

DECL 26 SEP 80.

~~SECRET~~

SECRET



SECRET

SOUTHERN
UNITED STATES
MEXICO BORDER

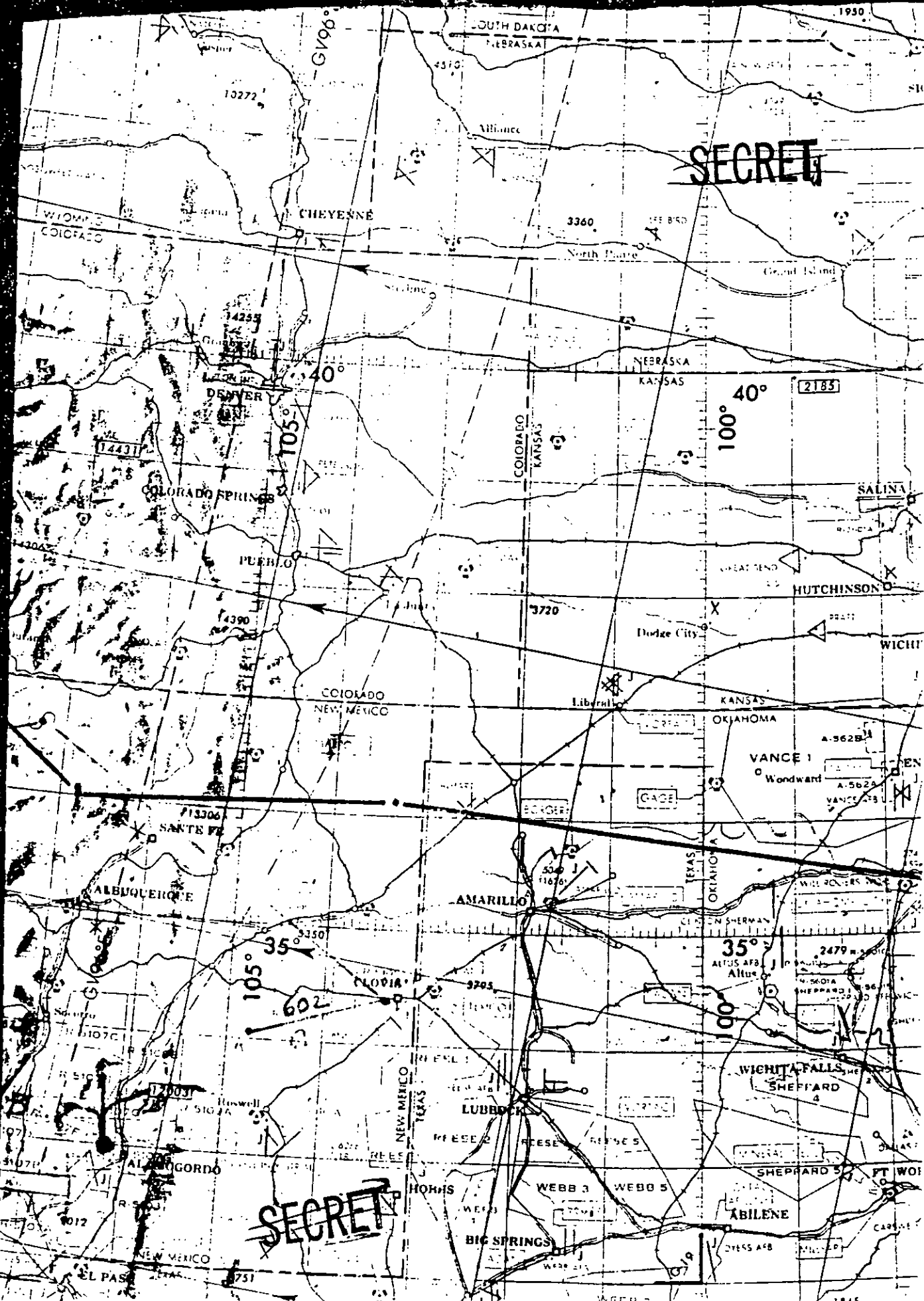

SECRET

SECRET

~~SECRET NOFORN~~

FRA

STORM CLOUD

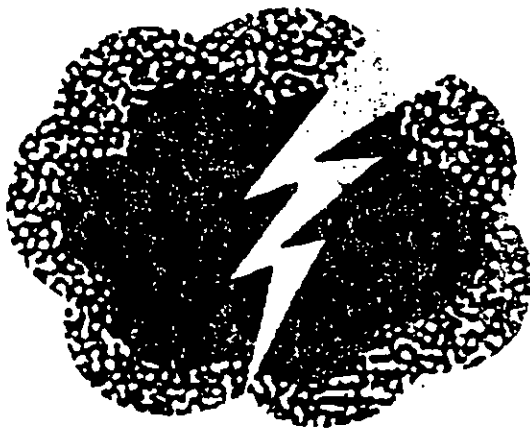

CLASSIFIED BY JCS, J-3, JTD
REVIEW ON 15 NOVEMBER 2000
EXTENDED BY JCS, J-3,
REASON 5200.1R, PAR 2-301c(5)

~~SECRET NOFORN~~

~~SECRET~~

0

00

SSBS

JCS WASHINGTON DC//JE//
HQ MAC SCOTT AFB//DO//
USCINCRD MACDILL AFB FL
TAC LANGLEY AFB VA//DO//DOOW//
12AF BERGSTROM AFB TX//DO//
15AF MARCH AFB CA//DO/LG//
552 AWACW TINKER AFB OK//CC//DO//963//
78MW CARSWELL AFB//DO//MA//
228MW MARCH AFB CA//DO//MA//
452 AREFW MARCH AFB//DO//
COMFITAEWINGPAC SAN DIEGO CA
474TFW NELLIS AFB, NV//DO//

~~SECRET~~

SUBJ: FRAG ORDER FOR STORM CLOUD E-3A/F-14 EXERCISE (U)

PART I. CONCEPT OF OPERATION

1. ^(U) OBJECTIVES: TO EXERCISE CAPABILITIES OF RAPID REACTION FORCES AND TO EVALUATE COMMAND AND CONTROL, AND COMMUNICATIONS

CJCS SJCS DJS JE JE/JTD

[REDACTED] LTCOL, USMC
J-3/JTD, EXT 55805, 13 NOV 80

~~SECRET~~

2 0

00

SSSS

INTERFACES AMONG AIR, GROUND, AND NAVAL ELEMENTS IN A SIMULATED HOSTILE ENVIRONMENT. EXERCISE DATE IS 21/22 NOV.

A 24-HOUR WEATHER DELAY WILL BE ORDERED IF REQUIRED.

2. ^(U) ~~(S)~~ PARTICIPANTS: 552 AWAC^W, COMFITAEWINGPAC, 474TFW, 78MW {CARSWELL}, 228MW AND 452 AREFB {MARCH}.

A. ^(U) ~~(S)~~ 552 AWACW: PROVIDE ONE PRIMARY E-3A TO BE ON STATION AS REQUIRED FOR BATTLE MANAGEMENT/ASSISTANCE, CAP CONTROL, AND OVERALL SURVEILLANCE.

B. ^(U) ~~(S)~~ COMFITAEWINGPAC: PROVIDE TWO F-14 EACH FOR CAP STATIONS A, B, AND C {AR AREA}/REMAIN ON STATION ~~UNTIL~~ UNTIL FORCE ROLLBACK.

C. ^(U) ~~(S)~~ NELLIS AGGRESSORS: 474TFW PROVIDE EIGHT F-4 TRACKS TARGETED AGAINST THE INDIAN SPRINGS AF AUX AREA. SEE PART V, THIS MESSAGE FOR DETAILS.

D. ^(U) ~~(S)~~ MIRAMAR ^{IS} ~~(S)~~ AGGRESSORS: VF 301 AND VF 302 PROVIDE TWO F-4 PER SQUADRON TARGETED AGAINST THE INDIAN SPRINGS AF AUX AREA. SEE PART V, THIS MESSAGE FOR DETAILS.

E. ^(U) ~~(S)~~ KC-135 SUPPORT: SUPPORT F-14 SORTIES AND E-3A REFUELINGS AS SPECIFIED IN PART VI, THIS MESSAGE.

03 0

00. SSSS

PART II. E-3A OPERATIONS

1. ^(U) ~~(S)~~ ASSETS REQUIRED: ONE E-3A WILL DEPART TINKER AFB AT APPROXIMATELY 2300Z 23 NOV 80. ONE GROUND SPARE TO BE AVAILABLE IN CASE OF PARIMY E-3A ABORT.
2. ^(U) ~~(S)~~ E-3A MISSION NARRATIVE: AFTER DEPARTURE FROM TINKER AFB, REFUEL ON AR 312. POST AR FLY TO ALAMOSA VORTAC TO ENTER LOW LEVEL ROUTE. FLY LOW LEVEL (5000 AGL) FOR 1 HR 56 MIN. EXIT LOW LEVEL ROUTE AT GRAND CANYON VORTAC, PROCEED DIRECT TO EXERCISE ORBIT, ARRIVING NLT 22/0845Z. ORBIT LOBES ARE NEEDLES VORTAC (EED) AND THE POINT EED/062/100. REMAIN ON STATION AT FL290 FOR FOUR HOURS AND BE AVAILABLE ~~TO~~ ^{AS REQUIRED} ASSIST ~~THE~~ DURING FORCE ROLLBACK. RTB TINKER AFB.

^

^^

PART III. F-14 OPERATIONS

1. ^(U) ~~(S)~~ ASSETS ~~REQUIRED~~: THREE NAS MIRAMAR SQUADRONS WILL ^{PROVIDE} PRIMARY F-14A (TWO PER SQUADRON) PLUS ^{THREE} A SPARE F-14A (ONE PER SQUADRON) FOR THE EXERCISE.
 - A. ^(U) ~~(S)~~ AIRCRAFT CONFIGURATION: TWO ~~X~~ F-14A'S WILL BE CONFIGURED WITH 4 AIM-54A, 2 AIM-7F, 2 AIM-9L, EXTERNAL TANKS,

^

^

74 0

00

SSSS

APX-76, OPERATIVE MODE IV, OPERATIVE AUTOPILOT, TADIL-C, AND KY-28. FOUR F-14A WITH 1 AIM-54A {2 AIM-54A RAILS}, 2 AIM-7F, 2 AIM-9L, AND AVIONIC EQUIPMENT AS ABOVE. SPARE AIRCRAFT WILL BE CONFIGURED THE SAME AS THE 4 F-14'S ABOVE.

B. ^(U) ~~(S)~~ EXERCISE CONSTRUCTIVE WEAPONS LOAD IS 4 AIM-54A, 2 AIM-7F, 2 AIM-9L PLUS AMMO. ~~THIS IS THE LOAD PARTICIPANTS WILL USE FOR WEAPONS EXPENDITURES TOTALS.~~

2. ^(U) ~~(S)~~ F-14 MISSION NARRATIVE:

A. ^(U) ~~(S)~~ SIX F-14A LAUNCH FROM MIRAMAR NAS TO RENDEZVOUS IN W-291. PROCEED TO HAILE INTERSECTION AT 16,000 FT TO RENDEZVOUS WITH KC-135 AT 22/0125Z. AT HAILE INTERSECTION DESCEND ~~0~~ 12,000 FT AND PROCEED WITH TANKER TO EXERCISE AREA VIA THE FOLLOWING ROUTE: V66 TO GBN {GILA BEND}, TO PHX {PHOENIX}, VIA V190 TO SJN {ST JOHNS} {CLIMB TO 14,000 FT}, TO TBC {TUBA CITY} {CLIMB TO FL240}, TO MMM {MORMAN MESA}. FIGHTER TANKING WILL COMMENCE AT GBN. ALL FIGHTERS MAINTAIN COMBAT PACKAGE ENROUTE. VIVID 01/02 TOP OFF JUST PRIOR TO MMM AND THEN PROCEED TO ARRIVE ON STATION AT CAP ALPHA NLT 0855Z. VIVID 03/04 TOP OFF, PROCEED TO ARRIVE ON STATION AT CAP BRAVO NLT

7F Span
Rec
9L-Side

A

75 0

00

SSSS

0915Z. VIVID 05/06 REMAIN WITH TANKER ON TRACK {CAP CHARLIE}.

B. ^(U)~~(S)~~ F-14A'S WILL MAINTAIN TWO AIRCRAFT ON CAP STATION AT ALL TIMES. RELIEVE ON STATION ONE AIRCRAFT AT A TIME. COMBAT PACKAGE AND LOCATIONS WILL BE:

CAP ALPHA	9000 LBS	3635N	11540W	
CAP BRAVO	9000 LBS	3540N	11540W	
CAP CHARLIE	NA	3628N	11430W TO 11457W	{AR AREA}

AIRCRAFT ON STATION ALPHA/BRAVO CALL E-3A VIA SECURE VOICE 20 MINUTES PRIOR TO ~~REQUIRED~~ ^{REQUIRING} COMBAT PACKAGE. DURING TANKING, ALL F-14A UTILIZE "ZIPLIP" PROCEDURES. USE FL210 AS BASE ALTITUDE FOR REFUELING.

C. ^(U)~~(S)~~ AT MISSION ROLLBACK, OR ON COMMAND, RETURN TO BASE VIA MOST EXPEDITIOUS ROUTE. EXPECT MISSION ROLLBACK AT APPROXIMATELY 1245Z. PLAN FUEL TO ARRIVE MIRAMAR NAS WITH 5,000 LBS.

3. ^(U)~~(S)~~ F-14 COMMAND AND CONTROL

A. ^(U)~~(S)~~ AIRCREW LINK-4A ADDRESSES AS PER PART VI, THIS MESSAGE. INSURE THAT LAST TWO DIGITS ARE ZERO ZERO ~~X~~ TO ENABLE AIRCREW TO ENTER VARIABLE ADDRESSES. SPARE AIRCRAFT WILL ENTER LAST TWO

76 0

00

SSCS

DIGITS TO CORRESPOND TO AIRCRAFT THEY REPLACE. SET MODES AND CODES AS PER PART VI, THIS MESSAGE.

B. ^(U) ~~(S)~~ AIRCREWS USE KY-28/LINK 4A AS THE PRIMARY MEANS OF COMMAND AND CONTROL. ^{USE} KY-28 EXERCISE KEY LIST ^{AS SPECIFIED IN} ~~TO DAY~~ ^{PART VI THIS MSG.} ~~SPECIFIED IN G-01 FOR ALL PRIMARY AND SECONDARY AIRCRAFT. THIS KEY LIST DAY WILL BE USED THROUGHOUT THE EXERCISE.~~

C. ^(U) ~~(S)~~ ALL AIRCREWS CHECK SECURE VOICE ASAP AFTER TAKEOFF. THEREAFTER, NO TRANSMISSIONS WILL BE MADE UNTIL ²² ~~R~~/0845Z. A

D. ^(U) ~~(S)~~ ID PROCEDURES FOR FRIENDLY AIRCRAFT WILL BE VIA IFF MODES 1, 2, 4. HOSTILE AIRCRAFT WILL BE IDENTIFIED VIA MODES 3, 4.

~~(S)~~ PART IV. KC-135 OPERATIONS

1. ^(U) ~~(S)~~ ASSETS REQUIRED: 22BMW AND 452 AREFW (MARCH) WILL PROVIDE FOUR DROQUE CONFIGURED, KY-28 EQUIPPED, KC-135 SORTIES FOR F-14 SUPPORT. ~~FA~~ BMW (CARSWELL) WILL PROVIDE ONE BOOM EQUIPPED KC-135 FOR E-3A SUPPORT. ALL LAUNCHES WILL BE GROUND SPARED. ^

2. ^(U) ~~(S)~~ F-14 SUPPORT

A. ^(U) ~~(S)~~ GENERAL: STRICT RADIO DISCIPLINE IS ~~ASSUMED~~. A

07 0

00 5555

ESSENTIAL FOR THIS MISSION; RENDEZVOUS AND REFUELING OPERATIONS WILL BE RADIO SILENT UNLESS SAFETY DICTATES OTHERWISE. VISUAL SIGNALS IN T.O.L-1C-1-3 WILL APPLY. F-14'S WILL CYCLE FROM THEIR LEFT TO RIGHT FOR A/R, AND INDICATE READY FOR REFUELING BY EXTENDING PROBE.

B. ^(U) ~~(S)~~ MISSION NARRATIVE:

^(U) ~~(S)~~ GILA 11 AND 12 (TANKERS ONE AND TWO) WILL ESCORT F-14'S TO EXERCISE AREA. ROUTE OF FLIGHT IS: DEPART KRIV (MARCH AFB), SKYES-1 (LEVEL OFF 11,000 BLK 13,000), OCN (OCEANSIDE), MZB (MISSION BAY), HAILE ^(U) ~~(S)~~ F-14 WILL JOINT TANKERS ENROUTE AT HAILE AT 0825Z, V66 GBN, PHX, V190, SJN (START CLIMB TO 12,000 BLK 14,000 AT SJN), TBC (START CLIMB TO FL220 BLK 240 AT TBC) MMM (CROSS MMM AT 0845Z), MMM 160/70. GILA 12 WILL PLAN TO OPTIMIZE OFFLOAD TO CROSS MMM 160/70 WITH BINGO FUEL OF 3DM AND RTB TO KRIV AT FL 350. GILA 11 WILL REMAIN IN THE TANKER ORBIT AREA AT FL240 UNTIL 0945Z OR BINGO FUEL. (SEE PARA (2) BELOW).

↑
↑
↑

78 0

00 5555

(U)
(2) ~~(S)~~ SUBSEQUENT REFUELINGS WILL BE ACCOMPLISHED UPON RECEIVER REQUEST, IN THE EXERCISE TANKER ORBIT AREA. ORBIT AREA IS DEFINED AS MMM 160/20 SOUTHWEST TO 160/70 LEFT TURNS WITH A 20NM OFFSET TO THE SOUTHEAST OF THE MMM 160 DEGREE RADIAL. GILA 13 AND 14 WILL ENTER AREA OF OPERATIONS VIA TWENTY NINE PALMS DIRECT GOFFS. CONTACT SCORPION ON 229.1 SECURE PRIOR TO GOFFS. GILA 13 WILL ARRIVE AT THE TANKER ORBIT AREA AT 0945Z, FL220, AND REMAIN ON STATION, AFTER CONFIRMING OFFLOAD CAPABILITY, UNTIL 1130Z. GILA 14 WILL ARRIVE AT THE TANKER ORBIT AT 1115Z, FL240, AND REMAIN ON STATION, AFTER CONFIRMING OFFLOAD CAPABILITY, UNTIL 1245Z OR UNTIL ALL RECEIVER FUEL REQUIREMENTS ARE SATISFIED.

(U)
C. ~~(S)~~ COMMUNICATIONS: GILA 11/12 WILL REMAIN ON A/R FREQUENCY {CLEAR VOICE} AND ATC FREQUENCY UNTIL DIRECTED BY CENTER TO CONTACT MISSION CONTROL. AT THAT TIME, MONITOR CAP CONTROL ON SECURE VOICE, A/R FREQUENCY ON CLEAR VOICE. GILA 13/14 REMAIN ON ATC FREQUENCY UNTIL DIRECTED BY CENTER TO CONTACT MISSION CONTROL. AT THAT TIME, MONITOR CAP CONTROL ON SECURE VOICE, A/R FREQUENCY

09 0

00

SSSS

ON CLEAR VOICE. FOR SECURE VOICE, SEE PART VI. FREQUENCIES:
REFUELING PRIMARY 372.3/264.9 (B/U) CAP CONTROL 229.1/312.8 (B/U)

*Slawits
AA*

3. (U) E-3A SUPPORT: 7 BMW WILL REFUEL E-3A IN AR 312W, USING
POINT PARALLEL RENDEZVOUS 552 AWACS WILL COORDINATE TRACK USE WITH
443 MAW.

TANKER CALL SIGN	E-3A CALL SIGN	TRACK	ARCT	ALT	OFFLOAD
51	TONIC XX	312W	TBD	220	20K

C/R PLAN: AS PUBLISHED IN FLIP 1B.

PART V. AGGRESSOR OPERATIONS:

1. (U) ALL AGGRESSOR FORCES WILL FOLLOW THE GUIDANCE PROVIDED IN
THIS FRAG AND WILL NOT DEVIATE FROM BRIEFED PROCEDURES. AGGRESSORS
WILL FILE FLIGHT PLANS WITH A MINIMUM 10 MINUTE SEPARATION BETWEEN
AIRCRAFT LAUNCHES, ALL AGGRESSORS WILL HAVE A FULLY OPERATIONAL
IFF/SIF AND OPERATE ON ASSIGNED MODES AND CODES AS PART PART VI,
THIS MESSAGE. THESE MODES AND CODES, PLUS "STORM CLOUD PARTICIPANT"
SHOULD BE INCLUDED IN THE REMARKS SECTION OF DD 175.

2. (U) NELLIS AGGRESSORS:

A. (U) ASSETS ~~REQUIRED~~: 474TFW WILL GENERATE F-4 AIRCRAFT TO
PROVIDE ^{EIGHT} TRACKS TARGETED AGAINST THE INDIAN SPRINGS AF AUX TARGET

A

10 0

00

SSSS

2012

AREA. A TRACKS EACH ATTACKING FROM JUMP-OFF POINTS AT BEATTY 270 DEGREE/20NM AND NAVY CHINA LAKE. IF FUEL AND ATTACK WINDOW TIME PERMIT, AIRCRAFT SHOULD RECYCLE FROM ABOVE POINTS.

B. (U) ~~PROCEDURES~~: ~~REQUIREMENTS~~ AGGRESSOR ATTACK RUN WILL CONSIST OF OVERFLIGHT OF THE INDIAN SPRINGS AF AUX TARGET AREA AT ALTITUDES BETWEEN 10,000 AND 14,000 FT. ~~DO NOT FLY BELOW 10,000 FT OR~~

~~ABOVE 14,000.~~ **ALTITUDE BLOCK ASSIGNMENT MUST BE ADHERED TO FOR FLIGHT SAFETY.**

C. (U) ~~PROCEDURES~~: NARRATIVE: TAKEOFF TIME WILL BE ANYTIME BETWEEN 22/0945Z AND 22/1245Z NOV 80. NO CLOSER THAN 10 MINUTES APART.

THE FIRST TRACK FOR BEATTY 270 DEGREE/20NM POINT MUST BE IN POSITION TO DEPART POINT ON ATTACK HEADING AT 0855Z. ROUTE OF FLIGHT TO BEATTY POINT WILL BE VIA HIGHWAY I DEPARTURE, TO BEATTY, TO BEATTY 270/20NM TO INDIAN SPRINGS AF AUX TARGET AREA. START SQUAWKING WHEN AIRCRAFT DEPARTS BEATTY POINT. SORTIES DEPARTING BEATTY POINT WILL DO SO AT 230 KIAS AND THEN ACCELERATE TO ATTACK AIRSPEEDS. ROUTE OF FLIGHT TO NAVY CHINA LAKE WILL BE VIA RADAR VECTORS DIRECT NAVY CHINA LAKE, DIRECT INDIAN SPRINGS AF AUX TARGET AREA. START SQUAWKING WHEN

11 0

00

SSSS

AIRCRAFT DEPARTS CHINA LAKE. BE AT ASSIGNED ALTITUDE, ABOVE 10,000 FT AND BELOW 14,000 FT, A MINIMUM OF 20NM FROM TARGET AREA. ALL NELLIS AGGRESSOR AIRCRAFT WILL MAKE ONE CALL IN THE BLIND "[CALLSIGN] OVER TARGET" WHEN OVER TARGET.

B. (S) NAS MIRAMAR AGGRESSORS

A. (U) (U) ASSETS ~~REQUIRED~~: VF 31 AND VF 302 WILL PROVIDE F-4 PER SQUADRON, TO PROVIDE TRACKS AGAINST THE INDIAN SPRINGS AF AUX TARGET AREA. CONFIGURE WITH CENTERLINE TANK. Two
A

B. (U) (S) REQUIREMENTS: ATTACK WILL CONSIST OF OVERFLIGHT OF THE INDIAN SPRINGS AF AUX TARGET AREA AT ALTITUDES BETWEEN 15,000 FT AND 17,000 FT. ~~DO NOT FLY BELOW 15,000 FT NOR ABOVE~~

2,000 FT. MAINTAIN ALTITUDE BETWEEN 15-17K FOR SAFETY SEPARATION FROM OTHER EXERCISE AIRCRAFT.

C. (U) (S) NARRATIVE: TAKEOFF TIME WILL BE ANYTIME BETWEEN 22/0845Z AND 22/1245Z NOV 80, NO CLOSER THAN 10 MINUTES APART. ROUTE OF FLIGHT IS JULIAN 4 DEPARTURE TO THERMAL TRANSITION, DIRECT TO HECTOR, DIRECT TO SHADO (BOULDER 269/68NM). OUTBOUND ALTITUDE WILL BE FL330 TO SHADO. AT SHADO, DESCEND TO 15,000 - 17,000 FT, PROCEED TO OVERFLY INDIAN SPRINGS AF AUX TARGET AREA.

^ ^

12 0

00

SSSS

ADVISE CENTER OF ENROUTE DELAY IN R-4608. AFTER OVERFLIGHT REACTIVATE FLIGHT PLAN AND RTB VIA REVERSE OF OUTBOUND LEG.

4. (U) SAFETY:

A. (U) ALL AIRCRAFT ~~WILL~~ MONITOR ^{UNIFORM} GUARD {243.0}.

TRANSMIT ON THIS FREQUENCY ONLY IN THE INTEREST OF SAFETY.

B. (U) INTERCEPT ROE WILL BE IAW JM55-200.

C. (U) ALL INTERCEPTS WILL BE TERMINATED ~~WITHIN 5NM OF 8000~~

NO CLOSER THAN 5NM AND
150 FT ALTITUDE SEPARATION FROM TARGET.
~~AT THE TARGET~~

B. (U) REQUIREMENTS: ATTACK WILL CONSIST OF OVERFLIGHT OF THE INDIAN SPRINGS AF AUX TARGET AREA AT ALTITUDES BETWEEN 15,000 FT AND 17,000 FT. DO NOT FLY BELOW 15,000 FT NOR ABOVE 17,000 FT.

C. (U) NARRATIVE: TAKEOFF TIME WILL BE ANYTIME BETWEEN 22/0845Z AND 22/1245Z NOV 80. NO CLOSER THAN 10 MINUTES APART. ROUTE OF FLIGHT IS JULIAN 4 DEPARTURE TO THERMAL TRANSITION, DIRECT TO HECTOR, DIRECT TO SHADO (BOULDER 269/68NM). OUTBOUND ALTITUDE WILL BE FL330 TO SHADO. AT SHADO, DESCEND TO 15,000 - 17,000 FT, PROCEED TO OVERFLY INDIAN SPRINGS AF AUX TARGET AREA.

13 0

00

SSSS

PART VI. COMMUNICATIONS

1. ^(U)~~(S)~~ E-3A/F-14 AIR OPERATIONS

A. ^(U)~~(S)~~ CAP CONTROL - UHF SECURE

	PRIMARY	SECONDARY
CAP ALPHA	312.8	229.1
CAP BRAVO	312.8	229.1
CAP CHARLIE	229.1	312.8

B. ^(U)~~(S)~~ LINK 4A (TADIL-C) DATA

(1) FREQUENCIES

	PRIMARY	SECONDARY	TERTIARY
	313.6	303.1	320.9

(2) ALTITUDE CODES

ALTITUDES	HEADING	SPEED	MEANING	RESPONSE
35,000	AS ASSIGNED	.75M	OPS NORMAL	FLY COMMAND HEADING
50,000	AS ASSIGNED	.75M	ROLLBACK	FLY COMMAND HEADING, SQUAWK FLASH
60,000	AS ASSIGNED	.75M	CAP A	FLY TO CAP A
65,000	AS ASSIGNED	.75M	CAP B	FLY TO CAP B

~~SECRET~~

14 0

00

SSSS

ALTITUDES	HEADING	SPEED	MEANING	RESPONSE
70,000	AS ASSIGNED	.75M	GO TO TANKER	FLY COMMAND HEADING
75,000	090	.75M	NO TANKER ASSETS AVAILABLE PRESENT TIME	NONE
80,000	AS ASSIGNED	.75M	BANDITS AT ASSIGNED HEAD- INGS, DO NOT ENGAGE OR DISENGAGE	SQUAWK FLASH
85,000	AS ASSIGNED	.75M	ENGAGE BANDITS AND KILL	FLY COMMAND HEADING, SQUAWK
90,000	AS ASSIGNED	.75M	ALERT MESSAGE FOLLOWS	STAND BY FOR ADDITIONAL INFO
95,000	AS ASSIGNED	.75M	ACKNOWLEDGE LAST MSG	SQUAWK FLASH

~~SECRET~~

15 0

00

SSSS

C. ^(U)~~(S)~~ IFF/SIF MODES, CODES, AND LINK ADDRESSES:

F-14 CALL SIGNS	MODE I	MODE II	MODE III	AIRFRAME ADDRESS	AIRCRAFT ADDRESS
VIVID 1	21	2101	2101	02100	01
VIVID 2	21	2102	2102	02100	02
VIVID 3	21	2103	2103	02100	03
VIVID 4	21	2104	2104	02100	04
VIVID 5	21	2105	2105	02100	05
VIVID 6	21	2106	2106	02100	06
ALL VIVID SPARES	21	2100	2100	02100	TBD

D. ^(U)~~(S)~~ CALL SIGNS:

E-3A FLIGHT CREW - TONIC

E-3A MISSION CREW - SCORPION

F-14 - VIVID

KC-135 - GILA

2. ^(U)~~(S)~~ AGGRESSORS

A. ^(U) DIRECT COMMUNICATIONS WITH E-3A IS NOT REQUIRED. REMAIN ON ATC ASSIGNED FREQUENCY. MONITOR UHF GUARD {243.0} FOR SAFETY CALLS.

16 0

00

SSSS

B. (U) IFF/SIF CODES

NELLIS F-4:

CALLSIGN	MODE I	MODE II	MODE III
TBD BY AGGRESSOR	b1	6121	6121
FORCE	b1	6122	6122
	b1	6123	6123
	b1	6124	6124
	b1	6125	6125
	b1	6126	6126
	b1	6127	6127
	b1	6120	6120

MIRAMAR F-4

TBD BY AGGRESSOR			
FORCE	b1	6121	6121
	b1	6122	6122
	b1	6123	6123
	b1	6124	6124

17 0

00

SSSS

3. (U) ~~(S)~~ AIR REFUELING OPERATIONS

(U) ~~(S)~~ THE ~~REDACTED~~ KC-135 AND F-14'S ~~ON~~ CAP CHARLIE WILL USE

OK 20 10

FOLLOWING FREQUENCIES:

PRIMARY SECONDARY

229.1 ~~REDACTED~~

312.8

BOOM FREQUENCY:

PRIMARY SECONDARY

372.3

264.9

4. (U) ~~(S)~~ KEY LIST ~~EXERCISE DAY~~ FOR KY-28: ALL PARTICIPANTS (LESS AGGRESSORS) WILL USE NESTOR/USKAK-8588, EDITION C, DAY 10 THROUGHOUT THE EXERCISE.

AN

5. (U) ~~(S)~~ REPORTS: JCS/J-3 WILL PREPARE ~~THE~~ AFTER ACTION REPORT. INPUTS ARE REQUESTED AS FOLLOWS:

AWACS - FLIGHT PROFILE, FUEL CONSUMPTION DATA, AIR INTERCEPT LOG, AND OTHER COMMENTS.

COMFITAEWINGPAC - FLIGHT PROFILES, FUEL CONSUMPTION DATA, LIST OF PILOT/RIO PARTICIPANTS TO INCLUDE GRADE AND SS NUMBER (INCLUDE THOSE THAT PARTICIPATED IN SENTINEL SWORD AND POISON

~~SECRET~~

18 0

00 SSSS

DART3, PHYSIOLOGICAL DATA FOR LONG
DURATION MISSION, AND OTHER COMMENTS.

SAC - FLIGHT PROFILES, FUEL CONSUMPTION DATA, OFFLOAD PER
AIRCRAFT AND OTHER COMMENTS.

AGGRESSORS - FLIGHT PROFILES AND OTHER COMMENTS.

REQUEST PROVIDE ABOVE TO JCS/J-3, JTD, THE PENTAGON,
WASHINGTON, D.C. 20301, BY 30 NOV. COMMENTS SHOULD EMPHASIZE
IDENTIFICATION OF ANY OPERATIONAL PROBLEMS, EQUIPMENT REQUIRE-
MENTS AND LESSONS LEARNED.

REVW 17 NOV 2000

~~SECRET~~